



# TOOLS & TESTING INSTRUMENTS





Empower your operations with our comprehensive range of Test Instruments, Tools & Gensets. Our high-precision instruments and durable tools are essential for accurate diagnostics and maintenance across various industries. These products ensure uninterrupted power and operational efficiency.



THINK ELECTRICAL

**NEW**

## DIGITAL MULTIMETERS

	Basic Multimeters			Industrial Range	
					
<b>Code</b>	<b>C-LOGIC-55</b>	<b>C-LOGIC-520</b>	<b>C-LOGIC-5100</b>	<b>C-LOGIC-5200</b>	<b>C-LOGIC-5600</b>
<b>Features</b>	<ul style="list-style-type: none"> <li>• Pocket Size</li> <li>• Integrated Test Leads</li> <li>• Low Battery Display</li> </ul>	<ul style="list-style-type: none"> <li>• Rubber Housing</li> <li>• Hinged Bracket</li> <li>• Low Battery Display</li> </ul>	<ul style="list-style-type: none"> <li>• Rubber Housing</li> <li>• Hinged Bracket</li> <li>• Low Battery Display</li> </ul>	<ul style="list-style-type: none"> <li>• Rubber Housing</li> <li>• Hinged Bracket</li> <li>• Low Battery Display</li> <li>• Professional Reference Industrial Multimeter</li> <li>• Duty Cycle</li> </ul>	<ul style="list-style-type: none"> <li>• Rubber Housing</li> <li>• Hinged Bracket</li> <li>• Cat. IV 600V</li> </ul>
<b>Ranges:</b>					
Display counts	2000	2000	2000	6600	6600
AC Voltage	300V	600V	600V	1000V	1000V
DC Voltage	300V	600V	600V	1000V	1000V
AC Current	200mA	-	10A	10A	10A
DC Current	-	10A	10A	10A	10A
Resistance	2MΩ	2MΩ	200MΩ	66MΩ	66MΩ
Capacitance	-	-	100μF	66mF	66mF
Frequency	-	-	20kHz	10kHz/66MHz	10kHz/66MHz
Continuity	Yes	Yes	Yes	Yes	Yes
Diode test	Yes	Yes	Transistor	Transistor	Transistor
Temperature	-	-	20°C-1000°C	0°C-1000°C	0°C-1000°C
Safety Rating	CAT III 300V	CAT III 600V	CAT III 600V	CAT III 1000V/ CAT IV 600V	CAT III 1000V/ CAT IV 600V
	<b>Environmental Multimeter</b>	<b>Smart Phone Connectivity</b>	<b>Smart Auto Ranging</b>	<b>Pen Type</b>	
					
<b>Code</b>	<b>C-LOGIC-5300</b>	<b>C-LOGIC-5900</b>	<b>C-LOGIC-580</b>	<b>C-LOGIC-3200</b>	
<b>Features</b>	<ul style="list-style-type: none"> <li>• Rubber Housing</li> <li>• Hinged Bracket</li> <li>• Duty Cycle, Humidity, Luminosity &amp; Sound Level</li> <li>• Professional Reference</li> </ul>	<ul style="list-style-type: none"> <li>• Rubber Housing</li> <li>• Hinged Bracket</li> <li>• Smart Phone Connectivity</li> <li>• Low Battery Display</li> <li>• Duty Cycle</li> </ul>	<ul style="list-style-type: none"> <li>• Smart Auto recognition of Measurement parameters</li> <li>• Auto Ranging</li> <li>• Dual Display</li> </ul>	<ul style="list-style-type: none"> <li>• Rubber Housing</li> <li>• Pen Type</li> <li>• Zero Adjustment</li> <li>• Logic Level Test</li> <li>• Low Battery Display</li> </ul>	
<b>Ranges:</b>					
Display counts	4000	4000	4000	2000	
AC Voltage	600V	600V	600V	600V	
DC Voltage	600V	600V	600V	600V	
AC Current	10A	10A	-	200mA	
DC Current	10A	10A	-	200mA	
Resistance	40mΩ	40mΩ	10MΩ	20MΩ	
Capacitance	100μF	99.99μF	3kHz	-	
Frequency	200kHz	10kHz	Yes	-	
Continuity	Yes	Yes	Yes	Yes	
Diode test	Transistor	Yes	-	Yes	
Temperature	20°C-1000°C	-	-	-	
Safety Rating	CAT III 600V	CAT III 600V	CAT III 600V	CAT III 600V	

**NEW**

## DIGITAL CLAMP METERS

	Large Jaw	Compact	Compact Professional	True RMS	Leakage Clamp Meter
<b>Code</b>	<b>C-LOGIC-80</b>	<b>C-LOGIC-85</b>	<b>C-LOGIC-810</b>	<b>C-LOGIC-8500</b>	<b>C-LOGIC-8730</b>
<b>Features</b>	<ul style="list-style-type: none"> <li>Jaw Size: 50mm</li> <li>Insulation test</li> <li>Low Battery Display</li> </ul>	<ul style="list-style-type: none"> <li>Jaw Size: 28mm</li> <li>Compact size</li> </ul>	<ul style="list-style-type: none"> <li>Jaw Size: 26mm</li> <li>Rubberized for grip</li> <li>Low Battery Display</li> <li>Duty Cycle</li> <li>Display backlight</li> </ul>	<ul style="list-style-type: none"> <li>Jaw Size: 40mm</li> <li>Rubberized for grip</li> <li>Low Battery Display</li> <li>Duty Cycle</li> <li>Auto ranging</li> <li>Max/ Min</li> <li>Display backlight</li> </ul>	<ul style="list-style-type: none"> <li>Jaw Size: 30mm</li> <li>Rubberized for grip</li> <li>Low pass filter function</li> <li>Zero Adjustment</li> <li>Low Battery Display</li> </ul>
<b>Ranges:</b>					
Display counts	2000	2000	6000	6000	4000
AC Voltage	750V	600V	600V	750V	600V
DC Voltage	1000V	600V	600V	1000V	600V
AC Current	1000A	400A	600A	1000A	150A
DC Current	-	-	-	1000A	-
Resistance	20mΩ	2kΩ	60MΩ	60MΩ	40MΩ
Capacitance	-	-	60mF	100mF	40mF
Frequency	-	-	1kHz/10kHz	1kHz/10kHz	-
Continuity	Yes	Yes	Yes	Yes	Yes
Diode test	No	Yes	Yes	Yes	Yes
Temperature	-	-	-20°C - +1000°C	-	-20°C - +1000°C
Safety Rating	CAT II 1000V / CAT III 600V	CAT III 600V	CAT III 1000V / CAT IV 600V	CAT III 1000V / CAT IV 600V	CAT III 600V

**NEW**

## VOLTAGE TESTERS

	Voltage Tester	Non Contact Voltage Testers	Phase Sequence Indicator
<b>Code</b>	<b>C-LOGIC-350</b>	<b>C-LOGIC-35</b>	<b>C-LOGIC-98</b>
<b>Features</b>	<ul style="list-style-type: none"> <li>Rubberized for grip</li> <li>Maximum test time: 30S (10min recovery)</li> </ul>	<ul style="list-style-type: none"> <li>Rubberized for grip</li> <li>Voltage sensitivity adjustment</li> <li>Low battery indication</li> </ul>	<ul style="list-style-type: none"> <li>Basic pen type Voltage tester</li> </ul>
<b>Ranges:</b>			
Test Voltage	12-400VAC	20-1000VAC	90-1000VAC
Frequency	50/60Hz	50-500Hz	50/60Hz
Indication	LED Bargraph -30% - +10%	LED and Acoustic	LED and Acoustic
Safety Rating	CAT III 400V	CAT II 1000V / CAT III 600V	CAT II 1000V

NEW

## ENVIRONMENTAL TESTERS

	Lightmeter	IR Thermometer	Anemometer	Digital Sound Level	Laser Tachometer
	<ul style="list-style-type: none"> <li>H REL</li> <li>Apo MAX MIN</li> <li>Lux CD</li> <li>FC OK Led</li> </ul>	<ul style="list-style-type: none"> <li>H MAX MIN</li> <li>E=0.95</li> </ul>	<ul style="list-style-type: none"> <li>Apo</li> <li>MAX MIN</li> <li>H</li> </ul>	<ul style="list-style-type: none"> <li>H MAX</li> <li>Apo</li> <li>AC WEIGHTING</li> </ul>	<ul style="list-style-type: none"> <li>Apo MAX MIN</li> <li>H LOG</li> </ul>
<b>Code</b>	<b>C-LOGIC-250</b>	<b>C-LOGIC-230</b>	<b>C-LOGIC-280</b>	<b>C-LOGIC-290</b>	<b>C-LOGIC-95</b>
<b>Features</b>	<ul style="list-style-type: none"> <li>• Rubberized housing for grip</li> <li>• Auto Ranging</li> <li>• Peak Measurement</li> <li>• Zero Calibration</li> <li>• Analogue bar graph</li> <li>• Low battery display</li> </ul>	<ul style="list-style-type: none"> <li>• Rubberized housing for grip</li> <li>• Convenient portable size</li> <li>• Low Battery display</li> <li>• °C / °F</li> </ul>	<ul style="list-style-type: none"> <li>• Rubberized housing for grip</li> <li>• Air speed</li> <li>• Temperature and Humidity</li> <li>• Air volume calculations</li> <li>• Display Backlight</li> <li>• Low battery display</li> </ul>	<ul style="list-style-type: none"> <li>• Rubberized housing for grip</li> <li>• Auto ranging</li> <li>• Analogue bargraph</li> <li>• Fast/Slow selection</li> <li>• Display Backlight</li> <li>• Low battery display</li> </ul>	<ul style="list-style-type: none"> <li>• Rubberized housing for grip</li> <li>• Non-contact measurement</li> <li>• Low battery display</li> </ul>
<b>Ranges:</b>	Lux: 0-200000Lux FC: 0-20000FC CD: 999900	Temperature: -20°C - +300°C Relative Humidity: 10%-90% Laser: <1mW / 630-670nm	Temperature: 10°C-60°C Relative Humidity: 20-90% Air speed: Meter/Sec: 0.8-40W km/h: 2.88 - 144km/h Other Units: ft/s, knots, mile/h, ft/m, Nautical miles	Range: 30dB - 130dB Dynamic Range: 50dB Freq range: 30Hz - 8KHz	Range: 50 - 99999RPM Measure Distance: 50-250mm





## MEASURING INSTRUMENTS SYMBOL GUIDE

Symbol	Description	Symbol	Description	Symbol	Description
	Continuity Test		Transistor		Luxes Measurement
	Diode Test		Back Light Display		Candle Measurement
	Auto Power Off		Data Hold		Foot-Candle Measurement
	Auto Range		Work Light		Valid for LED Light Measuring
	Max & Min Values		Max Value		Laser
	Non-Contact Voltage		Inrush Current		Over & Under Range Alert
	Low Impedance		Data Log		AC Weighting
	True Root Mean Square		Light Indicator		Relative Measurement
	Smartphone Connectivity		Metal Detection		Low Battery Display
	Acoustic Indicator				







**NEW**

**DIGITAL CLAMP METERS**





	Mini Digital	Digital Open Clamp	Mini AC/DC Current	1000AAC Clamp	1000AAC/DC Clamp
	 <ul style="list-style-type: none"> <li>Aperture: 26mm</li> <li>Features: Aperture, AUTO, MAX MIN, NCV, TRMS, H, INRUSH, LOG, REL, SMART</li> </ul>	 <ul style="list-style-type: none"> <li>Aperture: 12mm</li> <li>Features: Aperture, AUTO, MAX MIN, NCV, TRMS, Lo-Z, H, INRUSH, LOG, REL</li> </ul>	 <ul style="list-style-type: none"> <li>Aperture: 24mm</li> <li>Features: Aperture, AUTO, NCV, TRMS, H, INRUSH, LOG, REL</li> </ul>	 <ul style="list-style-type: none"> <li>Aperture: 40mm</li> <li>Features: Aperture, AUTO, MAX MIN, NCV, TRMS, H, INRUSH, LOG, REL</li> </ul>	 <ul style="list-style-type: none"> <li>Aperture: 40mm</li> <li>Features: Aperture, AUTO, MAX MIN, NCV, TRMS, H, INRUSH, LOG, REL</li> </ul>
<b>Code</b>	<b>KPS-PA900MINI</b>	<b>KPS-PA440</b>	<b>KPS-DCM200MINI</b>	<b>KPS-DCM3000</b>	<b>KPS-DCM4000T</b>
<b>Features</b>	<ul style="list-style-type: none"> <li>Mini digital clamp meter</li> <li>Dual reading</li> <li>Zero function</li> <li>Smart automatic detection of measurement parameter</li> </ul>	<ul style="list-style-type: none"> <li>Maximum voltage between circuit &amp; ground ≤1000V AC/DC</li> <li>Duty cycle</li> <li>Temperature</li> </ul>	<ul style="list-style-type: none"> <li>Pocket size simple &amp; reliable current measurements</li> <li>10mA Resolution</li> <li>Low pass filter</li> <li>Zero function</li> <li>Sampling rate: 2 times/sec</li> </ul>	<ul style="list-style-type: none"> <li>Calibration certification included</li> </ul>	<ul style="list-style-type: none"> <li>Calibration certification included</li> </ul>
<b>Ranges</b>					
Display counts	6000	6000	6000	6000	6000
AC Voltage	600V	600V	-	750V	750V
DC Voltage	600V	600V	-	1000V	1000V
AC Current	600A	200A	300A	1000A	1000A
DC Current	-	1000µA	300A	-	1000A
Resistance	10MΩ	60MΩ	-	20MΩ	20MΩ
Capacitance	-	60mF	-	-	6mF
Frequency	Yes	60MHz	-	-	60kHz
Temperature	-	400°C	-	-	760°C
Safety Rating	CAT III 600V	CAT III 600V	CAT III 600V	CAT III 1000V CAT IV 600V	CAT III 1000V CAT IV 600V

**NEW**

	2000V PV Clamp	Three Phase Power Clamp	Logging/Bluetooth Clamp	Leakage Clamp
	 <ul style="list-style-type: none"> <li>Aperture: 37mm</li> <li>Features: Aperture, AUTO, MAX MIN, NCV, TRMS, H, INRUSH, LOG, REL</li> </ul>	 <ul style="list-style-type: none"> <li>Aperture: 33mm</li> <li>Features: Aperture, AUTO, MAX MIN, TRMS, H, INRUSH, LOG, REL</li> </ul>	 <ul style="list-style-type: none"> <li>Aperture: 40mm</li> <li>Features: Aperture, AUTO, MAX MIN, NCV, Lo-Z, TRMS, H, INRUSH, LOG, REL</li> </ul>	 <ul style="list-style-type: none"> <li>Aperture: 40mm</li> <li>Features: Aperture, AUTO, MAX MIN, TRMS, H, INRUSH, LOG, REL</li> </ul>
<b>Code</b>	<b>KPS-DCM8500PV</b>	<b>KPS-DCM5000PW</b>	<b>KPS-DCM8000BT</b>	<b>KPS-DCM300LEAK</b>
<b>Features</b>	<ul style="list-style-type: none"> <li>Low-pass filter (HFR mode)</li> <li>Low current measurements (4000µAmps)</li> <li>Bluetooth connectivity</li> </ul>	<ul style="list-style-type: none"> <li>Auto store</li> <li>Phase rotation</li> <li>Low pass filter</li> <li>Bluetooth connectivity</li> <li>Harmonics, power, power factor measurements</li> </ul>	<ul style="list-style-type: none"> <li>Data Logging/Manual Save up to 4,000 records</li> <li>Bluetooth connectivity</li> <li>Low pass filter (HFR Mode)</li> </ul>	<ul style="list-style-type: none"> <li>Reliable measurements on circuits with harmonics or electric noise</li> <li>Leakage current measurement</li> <li>Switchable low-pass filter function</li> </ul>
<b>Ranges</b>				
Display counts	6000	10000	6000	6000
AC Voltage	1500V	1000V	1000V	-
DC Voltage	2000V	1000V	1000V	-
AC Current	600A	600A	600A	60A
DC Current	600A	-	600A	-
Resistance	600kΩ	100kΩ	600kΩ	-
Capacitance	1000µF	4mF	1000µF	-
Frequency	10kHz	10kHz	10kHz	-
Temperature	400°C	-	-	-
Safety Rating	CAT III 1000V CAT IV 600V	CAT III 1000V CAT IV 600V	CAT III 1000V CAT IV 600V	CAT III 600V



**NEW**

**DIGITAL CLAMP METERS**

	High Precision Logg.	Bluetooth DMM	With Lan tester	HVAC Digital	With Communication
					
<b>Code</b>	<b>KPS-DMM9000BT</b>	<b>KPS-DMM4500PV</b>	<b>KPS-MT480</b>	<b>KPS-DMM3500BT</b>	<b>KPS-MT920</b>
<b>Features</b>	<ul style="list-style-type: none"> <li>43 Segment analog display</li> <li>Dual display</li> <li>Auto detection 0.03% DCV accuracy</li> <li>Auto store up to 1000 registers</li> <li>Auto fuse detector</li> <li>Low-pass filter (HFR mode)</li> <li>Bluetooth &amp; optical USB interface</li> </ul>	<ul style="list-style-type: none"> <li>Suitable for industrial or solar applications</li> <li>Low-pass filter (HFR mode)</li> <li>Manual save up to 40000 records</li> <li>Bluetooth connectivity</li> </ul>	<ul style="list-style-type: none"> <li>Digital multimeter with Lan and phone cable tester</li> </ul>	<ul style="list-style-type: none"> <li>Specific functionalities such as temperature measurement through type K thermocouple or DC micro amps</li> <li>Micro amp measurements (4000uAmps)</li> <li>Low-pass filter (HFR mode)</li> <li>Low impedance mode</li> <li>Manual save up to 4000 records</li> <li>Bluetooth connectivity</li> </ul>	<ul style="list-style-type: none"> <li>Wireless connection</li> <li>Bluetooth connectivity</li> </ul>
<b>Ranges</b>	<ul style="list-style-type: none"> <li>Magnetic holder incl.</li> <li>Bluetooth &amp; USB</li> </ul>				
Display Counts	40000	6000	2000	6000	4000
AC Voltage	1000V	1500V	600V	1000V	600V
DC Voltage	1000V	2000V	600V	1000V	600V
AC Current	10A	10A	10A	10A	10A
DC Current	10A	10A	10A	10A	10A
Resistance	40MΩ	40MΩ	20MΩ	40MΩ	40MΩ
Capacitance	40mF	10μF	-	10μF	100mF
Frequency	100kHz	100kHz	-	100kHz	10MHz
Temperature	1200°C	400°C	-	400°C	-
Safety Rating	CAT IV 600V CAT III 1000V	CAT IV 600V CAT III 1000V	CAT III 600V	CAT III 1000V CAT IV 600V	CAT III 600V

**NEW**





**CABLES, TEST LEADS & THERMOCOUPLES**

	Test Cables						
							
<b>Code</b>	<b>KPS-PT15</b>	<b>KPS-PT20</b>	<b>KPS-PT30</b>	<b>KPS-CP300</b>	<b>KPS-CP400</b>	<b>KPS-CP420</b>	<b>KPS-CP500</b>
Test Cables	Yes	Yes	Yes	Yes	Yes	-	-
Test Leads for Insulation Test	-	-	-	-	-	Yes	-
Earth Resistance	-	-	-	-	-	-	Yes
Test Leads	Yes	Yes	Yes	-	Yes	-	-
Crocodile Clips	-	-	Yes	-	-	-	-
Built-in Fuses	-	-	-	-	Yes	-	-
Cable Length	800mm	1000mm	1000mm	1000mm	1500mm	2700mm	30/20/5m
Max Current	10A	10A	10A	10A	10A	2mA	2A
Safety Rating	CAT III 1000V	CAT III 1000V CAT IV 600V	CAT III 1000V CAT IV 600V	CAT III 1000V	CAT III 1000V CAT IV 600V	CAT III 10K VDC	CAT III 600V
	Crocodiles & Test Leads			Thermocouples			
							
<b>Code</b>	<b>KPS-PT100</b>	<b>KPS-PT120</b>	<b>KPS-PT200</b>	<b>KPS-TP100</b>	<b>KPS-TP120</b>	<b>KPS-TP300</b>	<b>KPS-TP320</b>
Test cables	-	-	Yes	-	-	-	-
Crocodile clips	Yes	Yes	-	-	-	-	-
Length	54mm	65mm	185mm	-	-	-	-
Max current	10A	10A	5A	-	-	-	-
Connector	-	-	-	Banana	Banana	Plug	Plug
Probe type	-	-	-	Thermocouple	Rod	Thermocouple	Rod
Temp. range	-	-	-	-40°C-260°C	-40°C-600°C	-40°C-260°C	-40°C-600°C
Cable Length	-	-	-	1000mm	1000mm	1000mm	1000mm
Safety Rating	CAT III 1000V	CAT III 1000V CAT IV 600V	CAT III 1000V CAT IV 600V	-	-	-	-

TEST INSTRUMENTS, TOOLS & GENSETS





**NEW**

## EARTH RESISTANCE/INSULATION TESTERS

	Earth Resistance Testers		Insulation Testers	
				
<b>Code</b>	<b>KPS-TLP100</b>	<b>KPS-TL300</b>	<b>KPS-MA500</b>	<b>KPS-MA100</b>
<b>Features</b>	<ul style="list-style-type: none"> <li>Earth resistance &amp; leakage current tester</li> <li>Measuring the earth resistance safely &amp; easily by clamping the ground line</li> <li>Setting alarm threshold</li> <li>data register</li> <li>Internal memory for recording measurements</li> </ul>	<ul style="list-style-type: none"> <li>2 Pole/3 Pole measurement method</li> <li>Test current: 3mA/ 800Hz</li> <li>Indication of the result numerically &amp; by means of a bar graph</li> <li>Internal memory for recording measurements</li> <li>Earth voltage measurement</li> </ul>	<ul style="list-style-type: none"> <li>Insulation tester up to 5kV with adjustable test voltage in 25V or 100V steps</li> <li>DAR/PI calculation</li> <li>Step voltage test</li> <li>Temperature compensation</li> <li>Compare function</li> <li>Data register &amp; PC software for downloading the results (USB)</li> </ul>	<ul style="list-style-type: none"> <li>Rugged, compact &amp; advanced insulation resistance tester</li> <li>Insulation Voltage test(50V, 100V, 250V, 500V &amp; 1000V)</li> <li>DAR/PI calculation</li> <li>Programmable timer</li> <li>Compare function</li> <li>Data register</li> </ul>
<b>Ranges</b>				
Display counts	10000	4000	10000	-
AC Voltage	-	200V	750V	750V
DC Voltage	-	-	1000V	1000V
AC Current	20A	-	-	-
DC Current	-	-	-	-
Resistance	1.200Ω	4.000Ω	-	200Ω
Insulation resist.	-	-	5TΩ	10GΩ
Leakage curr.	-	-	3mA	-
Capacitance	20A	-	-	-
Temperature	-	-	70°C	-
Safety Rating	CAT III 150V	CAT III 300V	CAT III 1000V CAT IV 600V	CAT III 1000V CAT IV 600V

**NEW**

## FLEXIBLE CURRENT PROBE/VOLTAGE TESTER

	Flexible Current Probe		Flexible Current Probe		Electrical tester
					
<b>Code</b>	<b>KPS-DCM4010FLEX</b>	<b>KPS-DCM3010FLEX</b>	<b>KPS-DCM4018FLEX</b>	<b>KPS-DCM3018FLEX</b>	<b>KPS-TP5000HY</b>
<b>Features</b>	<ul style="list-style-type: none"> <li>Capability with 10 inch (25cm) head cable length</li> <li>Large scale LCD display</li> </ul>	<ul style="list-style-type: none"> <li>AC capability with 10 inch (25cm) head cable length</li> <li>Slide switch to change range, voltage output to universal voltage meters</li> <li>7.5mm coil diameter for tightspace measurement</li> <li>2 meter extension cable low battery</li> <li>Ergonomically designed one-hand operation</li> </ul>	<ul style="list-style-type: none"> <li>LCD dual digital backlight display</li> <li>Fully automatic measuring</li> <li>AC Capability with 18inch(45cm) head cable length</li> <li>Bluetooth connectivity</li> </ul>	<ul style="list-style-type: none"> <li>AC capability with 10 inch (25cm) head cable length</li> <li>Slide switch to change range voltage output to universal voltage meters</li> <li>7.5mm coil diameter for tightspace measurement</li> <li>2 meter extension cable low battery</li> <li>Ergonomically designed one-hand operation</li> </ul>	<ul style="list-style-type: none"> <li>Digital display</li> <li>Bright LED bargraph</li> <li>Phase rotation indication</li> <li>Up to 16mm diameter conductor AWG 4/0 wire</li> <li>Auto polarity detection</li> <li>Single pole test</li> <li>Measure voltage without battery with LED bar &amp; LCD display</li> </ul>
<b>Ranges</b>					
Display counts	3000	-	10000	-	10000
AC Voltage	-	-	1000V	-	999.9V
DC Voltage	-	-	1000V	-	999.9V
AC Current	3000A	3000A	3000A	3000A	200A
Transformation Ratios	-	30A(100mV/A), 300A(10mV/A), 3000A(1mV/A)	-	30A(100mV/A), 300A(10mV/A), 3000A(1mV/A)	-
Resistance	-	-	10kΩ	-	50KΩ
Frequency	-	-	10kHz	-	-
Connectivity	-	-	BT	-	-
Phases seq./ Single phase	-	-	-	-	Sensibility (90V-1000V) Frequency: 45-65Hz
Safety Rating	CAT III 1000V CAT IV 600V	CAT III 1000V CAT IV 600V	CAT III 1000V CAT IV 600V	CAT III 1000V CAT IV 600V	CAT III 1000V CAT IV 600V

**NEW**

**POWER QUALITY ANALYZER**

**Power Quality Analyzer**

33mm



AUTO  
MAX  
MIN  
INRUSH  
REL



**Accessories (Included)**

Code	Description
KPS-VTL	Voltage test leads 4pcs
KPS-AL	Crocodile 4pcs
KPS-ULTRAFLEX3000	Rowgosity AC current clamps 3pcs
KPS-PSU & KPS-BAT	Battery pack (4x AA NiMH 2100mAh) 1 pc + external power supply + adapters 1set
KPS-TRANSPORTATION CASE	Protective case/storage

**Other items included in kit:**

- Calibration certificate
- User manual
- mSD 8Gb1

**Other Accessories (Not included)**

Code	Description
POWERCOMPACT/CL1000A	Amperometric mini, 52mm capacity (0.1-1000A Ac) Jaw capability (ø52mm, 1 busbar 50x5mm & 4 bus-bars 30x5mm)
POWERCOMPACT/CL200A	Amperometric mini, 20mm capacity 0.5-200A
POWERCOMPACT/CLA5A	Amperometric mini, 20mm capacity 0.01-5A
POWERCOMPACT/MAGTL	Probe measured magnetised for PQA, set of 4

**Functions**

- Two input channels
  - Main channel: 4 voltage inputs & 4 current inputs
  - Auxiliary channel: 2 voltage inputs & 1 current input
- Complete energy analysis: V, I, P, Q, S, F, PF, THD%, average / minimum / maximum values, instantaneous, energy consumed & generated, both three-phase & for each phase
- Harmonic measurement of voltage & current up to order 50 for each phase & for the neutral
- Load unbalance
- Record of events in the electrical system: interruptions, surges & brownouts
- Analysis of energy quality according to EN50160 standard
- Visualisation of voltage & current waveforms
- Adjustment of up to 4 tariff bands for calculating energy expenditure
- Register of 2 adjustable alarms
- Capture & registration of transients & starting currents
- Long term records with adjustable sampling period

Code	KPS-POWERCOMPACT3020
Dimensions	68x68mm
External power supply	Input 100-240VAC +/-10% 47-63Hz with interchangeable plug; output 7.5VDC-12W
Battery pack	4 x AA NiMH 2100mAh
Traditional Electric Analysis	V, I, P, Q, S, F, PF, THD(V)%, THD(I)%, cos, peaks, minimums, maximums, averages, max. demands, etc.
Neutral current	Measured
Three phase counters	kWh, kVAh, kVAh, absorbed & generated
Single phase counters	kWh, kVAh, kVAh, absorbed & generated
Cogeneration	Yes
Waveforms	V & I
Harmonics	Values & histograms up to the 50th order
Sags	Dips, swells & interruptions
Transients	Overvoltages & overcurrents
Unbalance	Yes
DC measures	Yes
K factor	Up to the 25th order
Alarms	Displayed
Alarms log	5 at display
Tariff bands	4
Energy costs	Yes
Sampling freq.	128 samples per cycle(40Hz-70Hz) 16 samples per cycle at 400Hz
Connections	Three-phase(3/4 leads), two-phase(2 leads) & single phase grid
Channels (Volt)	3 channels with common neutral + 1 independent, auxiliary channel
Direct measurement	Phase-phase: 7-1000VAC 40-70Hz, Phase-neutral: 5-600VAC 40-70Hz Aux: 5-1000VAC 40-70Hz, 10-1400VDC
Measurement with VT	Ratio:1-60000 Maximum value which can be displayed: 20MV
Channels (Curr)	5 independent channels
Measurement	Ratio: 1-60000
Current clamps	Maximum value which can be displayed: 500KA
Single phase power	Values < 999 GW, Gvar, GVA
Total power	Values< 999 GW, Gvar, GVA
RMS voltages	+/- 0.25%
RMS current	Scale 1 +/- 0.25% + 0.1%FS @ RMS I < 5% IN clamp Scale 2 +/- 0.25% + 0.05%FS @ 5% < RMS I < 20% IN clamp Scale 3 +/- 0.25% + 0.05%FS @ 20% < RMS I < 50% IN clamp Scale 4 +/- 0.25% + 0.05%FS @ > 50% IN clamp
Power factor	+/- 0.5°
Frequency	+/-0.01Hz (40-70Hz)
Active power count	Class 0.5
Reactive power count(kVar)	Class 1
Harmonic analysis	Up to 50th order Up to 7th at 400Hz
USB	to PC
Internal memory	64kB
External memory	Micro SD (4GB included)

TEST INSTRUMENTS, TOOLS & GENSETS



WHILE STOCKS LAST

DIGITAL MULTIMETERS



Code	MS320	MAS830	MS8321D	MS8233E	MS8301D	MY60
Features	<ul style="list-style-type: none"> <li>• Pocket size</li> <li>• LCD display</li> <li>• Auto ranging</li> <li>• Data hold</li> <li>• Auto power Off</li> <li>• Cat II 600V</li> <li>• Cat III 300V</li> </ul>	<ul style="list-style-type: none"> <li>• Pocket size</li> <li>• LCD display</li> <li>• Data hold</li> <li>• Cat II 600V</li> <li>• Cat III 600V</li> </ul>	<ul style="list-style-type: none"> <li>• Large LCD display</li> <li>• Data hold</li> <li>• Transistor tester</li> <li>• Auto Power Off</li> <li>• Cat II 1000V</li> <li>• Cat III 600V</li> </ul>	<ul style="list-style-type: none"> <li>• Non contact voltage detector</li> <li>• Back lit LCD display</li> <li>• Auto ranging</li> <li>• Max/Data hold</li> <li>• °C/°F (-20-1000°C)</li> <li>• Auto Power Off</li> <li>• Cat III 600V</li> </ul>	<ul style="list-style-type: none"> <li>• New smart auto testing meter auto detects type of test &amp; range.</li> <li>• Backlit LCD display</li> <li>• Auto Power off</li> <li>• Dual display</li> <li>• Max/Min/Data Hold</li> <li>• Non Contact Voltage</li> <li>• Cat III 600V</li> </ul>	<ul style="list-style-type: none"> <li>• Large LCD display</li> <li>• Data hold</li> <li>• Transistor tester</li> <li>• Auto power off</li> <li>• °C/°F (-20-1000°C)</li> <li>• Cat II 1000V</li> <li>• Cat III 600V</li> </ul>
<b>Ranges:</b>						
AC Voltage	4V - 600V	200V & 600V	2V - 750V	2V - 600V	6V - 600V	2V - 750V
DC Voltage	400mV - 600V	200mV - 600V	200mV - 1000V	200mV - 600V	6V - 600V	200mV - 1000V
Diode Test	Yes	Yes	Yes	Yes	—	Yes
AC Current	40mA - 400mA	—	2mA - 20A	200µA - 10A	—	2mA - 10A
DC Current	40mA - 400mA	200µA - 10A	200µA - 20A	200µA - 10A	—	2mA - 10A
Resistance	400Ω - 40MΩ	200Ω - 2MΩ	200Ω - 20MΩ	200Ω - 20MΩ	2kΩ - 10MΩ	200Ω - 200MΩ
Capacitance	4nF - 100µF	—	—	—	—	—
Frequency	0 - 100KHz	—	—	—	60Hz - 3kHz	—
Continuity	Yes	Yes	Yes	Yes	Yes	Yes















Code	MS8264	MS8250A	MS8253D	MS8340B	MS8228	MS8050
Features	<ul style="list-style-type: none"> <li>• Backlit LCD display</li> <li>• Data hold</li> <li>• Transistor tester</li> <li>• Auto Power Off</li> <li>• °C/°F</li> <li>• Cat II 1000V</li> <li>• Cat III 600V</li> </ul>	<ul style="list-style-type: none"> <li>• Non contact voltage detector</li> <li>• Backlit LCD display</li> <li>• Relative measurement</li> <li>• Auto ranging</li> <li>• Data hold</li> <li>• Auto power off</li> <li>• Duty Cycle</li> <li>• Cat IV 600V</li> </ul>	<ul style="list-style-type: none"> <li>• Non-Contact Voltage Detector</li> <li>• USB interface (Windows)</li> <li>• Backlit LCD Dual display</li> <li>• Relative Measurement</li> <li>• Auto Ranging</li> <li>• Max/Min/Data Hold</li> <li>• Auto power off</li> <li>• Duty Cycle</li> <li>• Cat IV 600V</li> </ul>	<ul style="list-style-type: none"> <li>• USB interface (Windows)</li> <li>• Peak measurement</li> <li>• Backlit LCD display</li> <li>• Bargraph display</li> <li>• Auto ranging</li> <li>• Auto power off</li> <li>• Max/Min/Data hold</li> <li>• Relative measurement</li> <li>• Duty Cycle</li> <li>• Cat III 1000V</li> </ul>	<ul style="list-style-type: none"> <li>• Relative humidity</li> <li>• Infrared/environmental thermometer</li> <li>• Backlit LCD Dual display</li> <li>• Auto ranging</li> <li>• Auto power off</li> <li>• Transistor tester</li> <li>• Data hold • Duty Cycle</li> <li>• Relative Measurement</li> <li>• Cat II 1000V • Cat III 600V</li> </ul>	<ul style="list-style-type: none"> <li>• VFD Display</li> <li>• PC Analysis Software</li> <li>• DataLogging: 30 Groups</li> <li>• USB interface (Windows)</li> <li>• Max/Min/Data Hold</li> <li>• Auto Ranging</li> <li>• Auto power off</li> <li>• Relative Measurement</li> <li>• Power Sup.: 110/220VAC</li> <li>• Cat II 1000V</li> </ul>
<b>Ranges:</b>						
AC Voltage	2V - 750V	400mV - 600V	660mV-1000V	2.2V - 700V	40mV - 750V	50mV-1000V
DC Voltage	200mV - 1000V	400mV - 600V	660mV-1000V	220mV - 1000V	40mV - 1000V	50mV-1000V
Diode Test	Yes	Yes	Yes	Yes	Yes	Yes
AC Current	2mA - 10A	400µA - 10A	660µA-10A	220µA - 10A	400µA - 10A	500µA-10A
DC Current	2mA - 10A	400µA - 10A	660µA-10A	220µA - 10A	400µA - 10A	500µA-5A/10A
Resistance	200Ω - 200MΩ	400Ω - 40MΩ	660Ω-66MΩ	220Ω - 220MΩ	400Ω - 40MΩ	500Ω-50mΩ
Capacitance	20nF - 20µF	50nF - 100µF	6.6nF-66mF	22nF - 220mF	50nF - 100µF	50nF-5000µF
Frequency	0 - 20KHz	0 - 5MHz	0-66MHz	0 - 220kHz	10Hz-100KHz	5Hz-2MHz / 5Hz-200kHz
Temperature	-20-1000°C	-	-	-	0 - 40°C / -20 - 300°C (IR)	-
Continuity	Yes	Yes	Yes	Yes	Yes	Yes



WHILE STOCKS LAST

**DIGITAL CLAMP METERS**





							
	<b>M266</b>	<b>MS2600</b>	<b>MS2033A</b>	<b>MS2000G</b>	<b>MS2026R</b>	<b>MS2015C</b>	<b>MS2102</b>
Features	<ul style="list-style-type: none"> <li>LCD display</li> <li>Data hold</li> <li>Jaw Size: 50mm</li> <li>Cat II 1000V</li> <li>Cat III 600V</li> </ul>	<ul style="list-style-type: none"> <li>Large backlit LCD display</li> <li>AutoRanging</li> <li>Max/Min/Data hold</li> <li>Auto Power Off</li> <li>Relative Measurement</li> <li>Jaw Size: 12mm</li> <li>Cat III 600V</li> </ul>	<ul style="list-style-type: none"> <li>New smart auto Testing. Meter auto detects type of test and range.</li> <li>Backlit LCD display</li> <li>Dual display</li> <li>Max/Min/Auto Data hold</li> <li>Jaw size: 26mm</li> <li>Cat III 600V</li> </ul>	<ul style="list-style-type: none"> <li>Backlit LCD display</li> <li>Data hold</li> <li>Jaw Size: 55mm</li> <li>Cat II 1000V</li> </ul>	<ul style="list-style-type: none"> <li>Backlit LCD display</li> <li>Max/Min/Data hold</li> <li>AutoRanging</li> <li>Auto Power Off</li> <li>Duty Cycle</li> <li>Work light (torch)</li> <li>Jaw Size: 40mm</li> <li>Cat III 600V</li> </ul>	<ul style="list-style-type: none"> <li>Backlit LCD Dual disp.</li> <li>Max/Min/Data hold</li> <li>Auto power off/ranging</li> <li>Bargraph display</li> <li>Non contact voltage detector</li> <li>Duty Cycle</li> <li>Relative measurement</li> <li>Work light (Torch)</li> <li>Jaw Size: 40mm</li> <li>Cat III 1000V</li> </ul>	<ul style="list-style-type: none"> <li>Large backlit LCD display</li> <li>Auto Ranging</li> <li>Auto Power Off</li> <li>Bargraph display</li> <li>Data hold</li> <li>Jaw Size: 28mm</li> <li>Cat II 600V</li> </ul>
<b>Ranges:</b>							
AC Voltage	750V	4V - 700V	6V - 600V	200V - 750V	6V - 750V	6.6V - 750V	400V - 600V
DC Voltage	1000V	4V - 1000V	6V - 600V	2V - 1000V	600mV - 1000V	660mV - 1000V	400V - 600V
Diode Test	—	Yes	—	Yes	Yes	Yes	—
AC Current	20A - 1000A	200A	2A - 600A	200A - 2000A	6A - 1000A	66A - 1000A	40A - 400A
DC Current	—	—	—	—	—	—	40A - 400A
Resistance	200Ω - 20KΩ	400Ω - 40MΩ	2kΩ - 10MΩ	200Ω - 2MΩ	600Ω - 60MΩ	660Ω - 66MΩ	400Ω
Capacitance	—	40nF - 40μF	—	—	40nF - 4000μF	6.6nF - 66mF	—
Frequency	—	0 - 100kHz	60Hz - 3kHz	0 - 20KHz	0 - 10MHz	0 - 10KHz	—
Temperature	—	—	—	0°C - 750°C	—	-20°C - 1000°C	—
Continuity Test	Yes	Yes	Yes	Yes	Yes	Yes	Yes

						
	<b>MS2108A</b>	<b>MS2108</b>	<b>MS2140B</b>	<b>MS2006B</b>	<b>MS2205</b>	<b>MS2208</b>
Features	<ul style="list-style-type: none"> <li>Backlit LCD display</li> <li>Max/Min/Data hold</li> <li>Auto ranging</li> <li>Work light (torch)</li> <li>Duty Cycle</li> <li>Jaw Size: 26mm</li> <li>Cat III 600V</li> </ul>	<ul style="list-style-type: none"> <li>Backlit LCD display</li> <li>Max/Min/Data hold</li> <li>Auto ranging</li> <li>Work light (torch)</li> <li>100msec inrush current measurement</li> <li>Duty Cycle</li> <li>Jaw Size: 26mm</li> <li>Cat III 600V</li> </ul>	<ul style="list-style-type: none"> <li>Backlit LCD Dual Display</li> <li>Non contact voltage detector</li> <li>Inrush Hold</li> <li>Work Light</li> <li>Relative Measurement</li> <li>Duty Cycle</li> <li>Bargraph Display</li> <li>Max/Min/Data Hold</li> <li>Auto Ranging</li> <li>Auto Power Off</li> <li>K-Type Thermocouple</li> <li>Jaw Size: 40mm</li> <li>Cat III 600V</li> </ul>	<ul style="list-style-type: none"> <li>High Sensitivity AC Leakage</li> <li>Large LCD display</li> <li>Data hold</li> <li>Auto Power Off</li> <li>Jaw Size: 31mm</li> <li>Cat III 600V</li> </ul>	<ul style="list-style-type: none"> <li>Large backlit LCD display</li> <li>True RMS</li> <li>Auto ranging</li> <li>Auto Power Off</li> <li>Max/Min/Data hold</li> <li>Data logging</li> <li>RS232 interface (Windows OS)</li> <li>Jaw Size: 50mm</li> <li>Cat III 600V</li> </ul>	<ul style="list-style-type: none"> <li>Large backlit LCD display</li> <li>True RMS</li> <li>Auto ranging</li> <li>Max/Min/Data hold</li> <li>Auto power Off</li> <li>Work light (torch)</li> <li>Jaw Size: 26mm</li> </ul>
<b>Ranges:</b>						
AC Voltage	400mV - 600V	660mV - 600V	600mV - 1000V	—	Volts: 0.1V - 600VAC	Volts: 0.1V - 600VAC
DC Voltage	400mV - 600V	660mV - 600V	600mV - 1000V	—	Amps: 0.01A - 1000AAC	Amps: 2mA - 200A AC
Diode Test	Yes	Yes	Yes	—	<b>Power:</b>	<b>Power:</b>
AC Current	40A - 400A	66A - 600A	600A - 1000A	2mA - 60A	Active: 0.01 - 600kW	Active: 0.1kW - 120kW
DC Current	40A - 400A	66A - 600A	600A - 1000A	—	Apparent: 0.001 - 600kVA	Apparent: 0.01 - 120kVA
Resistance	400Ω - 40MΩ	660Ω - 66MΩ	600Ω - 60MΩ	—	Reactive: 0.001 - 600kVAr	Reactive: 0.01 - 120kVAr
Capacitance	400nF - 4000μF	6.6μF - 66mF	6nF - 60mF	—	Harmonics: 45Hz - 65Hz	Harmonics: 30Hz - 1KHz
Frequency	0 - 10MHz	0 - 1KHz	60Hz-60mHz	—	1, 2-6, 7-8, 9-10, 11-15, 16-21	1, 2-6, 7-8, 9-10, 11-15, 16-21
Temperature	—	—	-40°C - 500°C	—	PF 0.3 - 1	PF 0.3 - 1
Continuity Test	Yes	Yes	Yes	—		

TEST INSTRUMENTS, TOOLS & GENSETS

WHILE STOCKS LAST

PEN TYPE TESTERS







	Multimeters			Non Contact Voltage Testers		Voltage tester
						
<b>Code</b>	<b>MS8211</b>	<b>MS8211D</b>	<b>Code</b>	<b>MS8900</b>	<b>MS8907</b>	<b>MS8922A</b>
<b>Features</b>	<ul style="list-style-type: none"> <li>• Non contact voltage detector</li> <li>• Retractable tip</li> <li>• Auto Ranging</li> <li>• Auto Power off</li> <li>• MAX/Data hold</li> </ul>	<ul style="list-style-type: none"> <li>• Logic level test</li> <li>• Retractable tip</li> <li>• Auto Ranging</li> <li>• Auto Power off</li> <li>• MAX/Data hold</li> <li>• Cat II 600V</li> </ul>	<b>Description</b>	<ul style="list-style-type: none"> <li>• Auto power off</li> <li>• Pocket clip</li> <li>• Cat II 600V</li> </ul>	<ul style="list-style-type: none"> <li>• Work light (torch)</li> <li>• Red and Green LED</li> <li>• Pocket clip</li> <li>• Cat II 1000V</li> <li>• Cat III 600V</li> </ul>	<ul style="list-style-type: none"> <li>• Max test time: 30s (10 min recovery)</li> <li>• CAT III 400V</li> </ul>
<b>Ranges:</b>			<b>Ranges:</b>			
AC Voltage	200mV-600V	200mV-600V	Test voltage AC	100-240V	50-1000V	12V-400V
DC Voltage	200mV-600V	200mV-600V	Test voltage DC	-	-	12V-400V
AC Current	-	20mA-200mA	Indication	Sound and light	Sound and light	LED bargraph
DC Current	-	20mA-200mA	Frequency	50-60Hz	50Hz/60Hz	50Hz/60Hz
Resistance	200Ω-20MΩ	200Ω-20MΩ				
Diode test	Yes	Yes				
Continuity	Yes	Yes				





SPECIALISED METERS

	Automotive Multimeter & Engine Analyser	SMD Tester	mA/V Process Calibrator	Process Thermocouple Calibrator	Capacitance Meter
					
<b>Code</b>	<b>MS8239D</b>	<b>MS8910</b>	<b>MS7221</b>	<b>MS7220</b>	<b>MS6013</b>
<b>Features</b>	<ul style="list-style-type: none"> <li>• Backlit LCD display</li> <li>• Dwell Test (Angle) 4 / 6 / 8 cylinder</li> <li>• Tach Test (Speed) 4 / 6 / 8 cylinder</li> <li>• Auto ranging</li> <li>• Max / Data hold</li> <li>• Auto Power Off</li> <li>• Cat III 600V</li> </ul>	<ul style="list-style-type: none"> <li>• LCD display</li> <li>• Auto Ranging</li> <li>• Auto Power Off</li> <li>• Data Hold</li> <li>• Auto Scanning</li> </ul>	<ul style="list-style-type: none"> <li>• Accurately measure loop currents</li> <li>• Measure voltage from process and PLC's</li> <li>• Source or Simulate 22mA loop currents</li> <li>• Simultaneous 24V loop supply and current measurement</li> </ul>	<ul style="list-style-type: none"> <li>• Measure and simulate thermocouples J,K,T,E,R,S,B,N</li> <li>• °C / °F</li> <li>• Temperature scale: ITS-90, NIST 175</li> <li>• Thermocouple Type</li> <li>• J: -200 - 1200°C</li> <li>• K: -200 - 1370°C</li> <li>• T: -200 - 400°C</li> <li>• E: -200 - 950°C</li> <li>• R: -20 - 1750°C</li> <li>• S: -20 - 1750°C</li> <li>• B: 600 - 1800°C</li> <li>• N: -250 - 1300°C</li> <li>• Millivolt In/out: -10-75mV</li> <li>• Max Input Volts: 30V</li> </ul>	<ul style="list-style-type: none"> <li>• Zero Adjustment</li> <li>• High Accuracy</li> <li>• Low battery display</li> <li>• 9 Ranges</li> </ul>
<b>Ranges</b>	Volts AC: 200mV - 600V Volts DC: 200mV - 600V AC Current: 10A DC Current: 10A Resistance: 200Ω - 20MΩ Diode Test Continuity Test	Resistance: 300Ω - 30MΩ Capacitance: 3nF-30mF	DC Voltage in/out: 0-100mV, 0.1-10V DC Current in/out: 0-24mA Loop Power: 24V		Capacitance: 200pF - 20mF

WHILE STOCKS LAST

**DIGITAL TESTERS**

	Digital Thermometer	Combustable Gas Detector	Digital Sound Level	Lightmeters		Anemometer/ Temperature/ Humidity
						
<b>Code</b>	<b>MS6511</b>	<b>MS6310</b>	<b>MS6700</b>	<b>MS6610</b>	<b>MS6612T</b>	<b>MS6252B</b>
<b>Features</b>	<ul style="list-style-type: none"> <li>• Thermocouple Types: K, J, T, E</li> <li>• Max / Min / AVG / Data hold</li> <li>• Auto power off</li> <li>• °C / °F / K</li> </ul>	<ul style="list-style-type: none"> <li>• Easily find gas leaks</li> <li>• High sensitivity</li> <li>• Warm-up time: 2mins</li> <li>• Response time: 2sec</li> <li>• Alarm Range: 10-40%</li> </ul>	<ul style="list-style-type: none"> <li>• Backlit LCD display</li> <li>• Max hold</li> <li>• Over range indication</li> <li>• Fast/Slow selection</li> <li>• Auto/Manual ranging</li> <li>• Auto power off</li> <li>• Bargraph indication</li> <li>• A/C Weighting</li> <li>• Date/Time display</li> </ul>	<ul style="list-style-type: none"> <li>• High Accuracy</li> <li>• Data Hold on the separate sensor allow easy measurement from the optimal position</li> <li>• Silicon Photo Diode with Filter</li> <li>• Lead Length: 150cm</li> </ul>	<ul style="list-style-type: none"> <li>• Auto Ranging</li> <li>• Auto Power Off</li> <li>• Max / Min / Peak / Data Hold</li> <li>• Relative Measurement</li> <li>• Zero Calibration</li> <li>• Analogue Bar Indication</li> <li>• Light Source Default Value Setting</li> </ul>	<ul style="list-style-type: none"> <li>• Backlit LCD display</li> <li>• Flow Area setting for volume calculation</li> <li>• Max/Min/Data Hold</li> <li>• Auto Power Off</li> <li>• Ambient/Dew Point/Wet Bulb Temperature</li> <li>• °C / °F • Humidity</li> <li>• USB Interface (Windows)</li> </ul>
<b>Ranges</b>	Temperature Range: K: -200°C - 1372°C J: -210°C - 1200°C T: -250°C - 400°C E: -150°C - 1000°C Resolution: 0.1°C/°F/K(<1000°) 1°C/°F/K(>1000°)	Gases Detected: • Natural gas • Methane • Ethane • Propane • Butane • Acetone • Alcohol • Ammonia • Steam • Gasoline • Jet Fuel • Napthta • Hydrogen Solvents • Carbon Monoxide • Lacquer Thinners	Range: 30dB - 130dB Dynamic Range: 50dB Resolution: 0.1dB Freq: 30Hz - 8KHz Sample Rate: 2/sec	Measurement Range: 0-1999Lux 2000-19990Lux 20000-50000Lux Accuracy: ±5%	Lux: 0 - 200 000Lux Fc: 0 - 20 000Fc Candela: 0 - 999 900Cd	Meter/Sec: 0.8-40m/s km/h: 2.88 - 144km/h Other Units: ft/s, knots, mile/h, ft/m Temperature: -10 - 60°C Relative humidity: 20 - 80%

Laser Tachometer	Contact Tachometer	Laser Distance Meters		Wire Tracer
				
<b>MS6208B</b>	<b>MS6208A</b>	<b>MS6404</b>	<b>MS6408</b>	<b>MS6812</b>
<ul style="list-style-type: none"> <li>• Backlit LCD display</li> <li>• Non Contact measurement</li> <li>• Auto power off</li> <li>• Max/Min Data hold</li> <li>• Data logging</li> </ul>	<ul style="list-style-type: none"> <li>• Backlit LCD display</li> <li>• Contact measurement</li> <li>• Auto power off</li> <li>• Max/Min Data hold</li> <li>• Data Logging</li> </ul>	<ul style="list-style-type: none"> <li>• Back-lit LCD Display</li> <li>• Pythagoras, Area, Volume Calculation</li> <li>• Continuous Measurement</li> <li>• Add/Subtract</li> <li>• Min/Max</li> <li>• Laser Pointer</li> <li>• Auto Power Off</li> <li>• Data Logging</li> <li>• Foot Level Measurement</li> </ul>	<ul style="list-style-type: none"> <li>• Back-lit LCD Display</li> <li>• Pythagoras, Area, Volume Calculation</li> <li>• Continuous Measurement</li> <li>• Add/Subtract</li> <li>• Min/Max</li> <li>• Laser Pointer</li> <li>• Auto Power Off</li> <li>• Data Logging</li> <li>• Foot Level Measurement</li> </ul>	<ul style="list-style-type: none"> <li>• Designed to identify &amp; trace wires or cables within a group without damaging the insulation</li> <li>• Continuity test</li> <li>• Volume control for increased sensitivity</li> <li>• Recessed ON/OFF button to prevent battery drain</li> </ul>
Range: 50-99999RPM Measure Distance: 50-250mm	Range: 50 - 19999RPM	Distance: 0.05-40m Units: m/mm/In/Ft	Distance: 0.05-80m Units: m/mm/In/Ft	Emitter tone frequency: 1.5kHz (Single) 1.3-1.5kHz (Dual) Receiver frequency range: 100-300kHz

TEST INSTRUMENTS, TOOLS & GENSETS











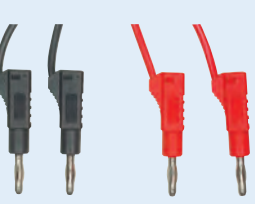

WHILE STOCKS LAST

## INSTALLATION TEST EQUIPMENT

	Circuit Analyser	Digital Insulation Multimeter	Digital Insulation Testers	Earth Resistance Testers	
					
<b>Code</b>	<b>MS5908C</b>	<b>MS5208</b>	<b>MS5215 (5000V)</b>	<b>MS2301</b>	<b>MS2307</b>
<b>Features</b>	<ul style="list-style-type: none"> <li>• Loop Impedance/PSC</li> <li>• Voltage Test: L-N/N-E/Peak</li> <li>• RCD / GFCI test</li> <li>• Frequency</li> <li>• 5A/8A/10A load for Volt drop test</li> <li>• Wiring test function</li> <li>• Cat III 300V</li> </ul>	<ul style="list-style-type: none"> <li>• DAR / PI Insulation mode</li> <li>• Backlit LCD display</li> <li>• Data logging</li> <li>• Auto / Manual ranging</li> <li>• Low Pass Filter</li> <li>• Max/Min/AVG/Data hold</li> <li>• Auto power off</li> <li>• Relative Measurement</li> <li>• Cat III 1000V</li> </ul>	<ul style="list-style-type: none"> <li>• Large Backlit LCD Display</li> <li>• Broad Range of Testing Voltages</li> <li>• Auto DAR/PI calculation</li> <li>• Step Voltage Measurements &amp; Temperature Compensation</li> <li>• Large Storage Memory</li> <li>• PC Communication</li> <li>• Robust &amp; Durable</li> <li>• Cat II 1000V</li> <li>• Cat II 600V</li> </ul>	<ul style="list-style-type: none"> <li>• Auto Power Off</li> <li>• Auto Ranging</li> <li>• Data Hold</li> <li>• Buzzer On Symbol</li> <li>• Data Logging 99 Groups</li> <li>• Alarm Limit Setting</li> <li>• Jaw Size: 45 x 32mm</li> <li>• Cat III 150V</li> </ul>	<ul style="list-style-type: none"> <li>• Auto Power Off</li> <li>• Dual Display dig/analog</li> <li>• Clock date/time</li> <li>• Average Value Measurement</li> <li>• Compensation Resistance</li> <li>• Alarm of Limit Value Groups</li> <li>• Alarm Limit Setting</li> <li>• Backlit LCD Display</li> <li>• Data Storage 100 Groups</li> <li>• USB 2.0 Interface</li> </ul>
<b>Ranges</b>	Line Volts: 85 - 265V Neutral/Ground: 0 - 10V Peak: 120 - 375V Freq: 45 - 65Hz Volt Drop: 0.1 - 99.9% Impedance (L/N/E): 0-3Ω RCD trip time: 1ms - 6.5s RCD trip Amp: 30mA GFCI trip time: 1ms - 6.5s GFCI trip Amp: 6mA	Insulation Function: 50V - 0-50MΩ 100V - 0-100MΩ 250V - 0-250MΩ 500V - 0-500MΩ 1000V - 0-2GΩ AC Voltage: 600mV - 750V DC Voltage: 600mV - 1000V Diode Test: Yes AC Current: 66mA - 400mA DC Current: 66mA - 400mA Resistance: 660Ω - 66MΩ Capacitance: 66nF - 66mF Frequency: 0-66kHz Temperature: -30°C-1300°C Continuity: Yes	Insulation Function: 250V - 0-250GΩ 500V - 0-500GΩ 1000V - 0-999GΩ 2500V - 0-2.5TΩ 5000V - 0-5TΩ AC Voltage: 750V DC Voltage: 1000V Resistance: 5TΩ Temperature: -10 - 70°C	Earth Resistance: 0-1200Ω Current: 100mA-20A	Earth Resistance: 0.1-30kΩ Test Voltage: 1-50VAC Current: 20mA-2A

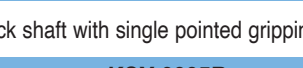
## TEST PROBES

							
<b>Code</b>	<b>ASL2</b>	<b>AL-12</b>	<b>AL-25</b>	<b>AL-26</b>	<b>FC-A23</b>	<b>PLSS150B</b> <b>PLSS150R</b>	<b>SP1322-R</b> Red <b>SP1322-BK</b> Black
					Black & Red Insulated Crocodile Clips (pair)	Lead with 4mm Plug to fit Digital Multimeters and other test probes.	Banana Plugs 4mm Male Plug with plastic handle
	<b>Car Fuse Adapter</b>						
							
<b>Code</b>	<b>CF-01</b>	<b>CF-01S</b>			<b>KSY-6005B</b>	<b>FC-170A</b>	
	MAXI-Blade	MINI-Blade			Black shaft with single pointed gripping jaws	Black and Red Test Probe (pair)	
							
<b>Code</b>					<b>KSY-6005R</b>	<b>FC-A15</b>	
					Red shaft with single pointed gripping jaws	Black and Red Test Clips (pair)	

## INSTALLATION TEST EQUIPMENT

Earth Leakage Testers			Socket Outlet & RCD Tester	Schuko Socket Outlet & RCD Tester	
<b>MINITRIP 1</b>	<b>MINITRIP 2</b>	<b>MINITRIP 1/L</b>	<b>TEL1-3 (230V)</b> <b>TEL1-4 (240V)</b>	<b>SCHUKI-2</b>	
<ul style="list-style-type: none"> <li>Wiring check</li> <li>5-35mA Stepped output. Earth current test rated at 230VAC</li> <li>50/60Hz</li> <li>Rotary switch selection</li> <li>Push button injection</li> </ul>	<ul style="list-style-type: none"> <li>Analogue</li> <li>10-50mA variable earth current</li> <li>Wiring check</li> <li>50/60Hz</li> <li>Potentiometer selection of fault current</li> <li>230VAC <math>\pm</math>15%</li> </ul>	<ul style="list-style-type: none"> <li>As <b>MINITRIP 1</b> with 15A plug and lead.</li> </ul>	<ul style="list-style-type: none"> <li>3 phase Earth Leakage Tester</li> <li>Analogue</li> <li>Potentiometer selection of fault current</li> <li>230VAC <math>\pm</math>15% (L/N)</li> <li>Phase Selector Switch</li> <li>50/60Hz</li> </ul>	<ul style="list-style-type: none"> <li>Verifies that the wiring is correct (Neon light indication)</li> <li>RCD testing with variable fault current</li> <li>Trip settings 10 - 35mA</li> </ul>	
<b>Phase Sequence Indicator</b>		<b>Digital Phase Indicator</b>	<b>CEE-Adaptor</b>	<b>Schuko Socket Outlet Tester</b>	<b>British Socket Outlet Tester</b>
<b>ST-850</b>		<b>SSP-8030</b>	<b>TV400-*</b>	<b>SCHUKI-3</b>	<b>MS6860E</b>
<ul style="list-style-type: none"> <li>Check phase sequence</li> <li>Open phase check</li> <li>Large alligator clips allow for easy connection &amp; testing</li> <li>90-600VAC</li> <li>50/60Hz</li> <li>c/w Carrying case</li> </ul>		<ul style="list-style-type: none"> <li>Designed to check the presence of open phase and phase sequence by LED and buzzer at the same time</li> <li>Operational Voltage: 200-480V AC 3 phase</li> <li>Freq. range: 20Hz-400Hz</li> </ul>	<ul style="list-style-type: none"> <li>With Phase Rotation Indication - 3P+N+E</li> <li>Confirms correct wiring</li> <li>Indicates phase rotation</li> <li>Can be used with SCHUKI-2 to test RCD</li> <li>* Add current rating to code: <b>16A, 32A</b></li> </ul>	<ul style="list-style-type: none"> <li>Confirms correct wiring of outlet</li> <li>Output via glowing lamps</li> </ul>	<ul style="list-style-type: none"> <li>Designed to test 110V or 220V sockets in 1 easy step</li> <li>Clear LED indication of wiring errors including missing earth, live/earth reverse, live/neutral reverse, missing neutral</li> </ul>
<b>Hand Crank Insulation Tester</b>	<b>Hand Held Insulation Tester</b>	<b>Digital Insulation Tester</b>	<b>Digital Insulation Tester</b>		
<b>NB311110</b>	<b>EM580F (500V)</b>	<b>IT811A (2500V)</b>	<b>2803IN (max 5kV)</b>	<b>2804IN (max 10kV)</b>	
<ul style="list-style-type: none"> <li>Insulation Resistance</li> </ul> <p>Test voltage 500V Ohm Meter: 0<math>\Omega</math> to 500M<math>\Omega</math></p>	<ul style="list-style-type: none"> <li>Fixed Time or Test Locked</li> <li>Data Hold</li> <li>Overload protection</li> <li>Backlit LCD Display</li> <li>Cat III 600V</li> </ul> <p>Test Ranges: 125V: 2/20/200M<math>\Omega</math> 250V: 20/200/500M<math>\Omega</math> 500V: 20/200/1000M<math>\Omega</math> AC/DC Voltage: 600VAC/DC</p>	<ul style="list-style-type: none"> <li>Auto discharge function</li> <li>Backlit LCD display</li> <li>Data hold</li> <li>Overload protection</li> <li>Backlit LCD Display</li> <li>Cat III 600V</li> </ul> <p>Test Voltage: 250/500/1000/2500V Resistance: 1m-20G<math>\Omega</math> AC Voltage: 0-750VAC</p>	<p>Designed for use by Panel Builders</p> <ul style="list-style-type: none"> <li>Non Destructive Test</li> <li>Limited Current</li> </ul> <ul style="list-style-type: none"> <li>Insulation resistance</li> <li>Bargraph indicates test voltage; rise and decay can be observed during tests</li> <li>Visual and audible warning if external voltage is present</li> <li>Enersave™ feature to extend battery life</li> <li>2 Lines x 16 char. large LCD</li> <li>Auto-off</li> <li>Show test time duration (up to 99.9s) for easy comparison</li> </ul> <p>Test Voltage (DC V): 0.5 / 1 / 2.5 / 5kV Measuring Ranges: 0-25 / 0-50 / 0-125 / 0-250G<math>\Omega</math></p>	<ul style="list-style-type: none"> <li>Auto ranging on all ranges</li> <li>Visual and audible warning if external voltage is present</li> <li>Enersave™ feature to extend battery life</li> <li>Auto-off</li> <li>Show test time duration (up to 99.9s) for easy comparison</li> </ul> <p>Test Voltage (DC V): 1 / 2.5 / 5 / 10kV Measuring Ranges: 0-50 / 0-125 / 0-250 / 0-500G<math>\Omega</math></p>	



## POWER QUALITY ANALYSERS







Code	MI-2892
Voltage: TRMS, peak, crest factor	4 Ch Cat III / 1000V
Current: TRMS, peak, crest factor	4 Ch (Auto clamp detection)
Power: P, Q, S	✓
Unbalance, flicker measurement	✓
Harmonic and THD measurement	✓
Interharmonics	✓
Energy (P, Q, Forward/backward)	✓
Events (interruptions, swells, dips)	✓
Inrush currents	✓
Waveform/Inrush	✓
Transients recording	✓
Power quality analysis EN 50160	✓
Recording of adjustable alarms	7
Temperature measurement	✓
Power factor cos φ	✓
PC software (Included)	PowerView 3
<b>Standard Set</b>	
1-phase flexible current clamps	4x 3000 / 300 / 30 A
Test probe/clip/leads	5 / 5 / 5
Temperature probe	1
Memory	8GB SD supplied
Communication	RS232, USB and Ethernet
PSU & Batteries	1
Soft carrying bag	1

Accessories	
Code	Description
A1069	Mini Clamp 100A/1V (range 2A - 100A)
A1122	Mini Clamp 5A/1V (range 2A - 100A)
A1039	Connection cable for current clamp
A1037-M	Current transformer 5A/1V
A1033-M	Current clamp 1000A/1V
A1257	3-phase flexible current clamps 3000/300/30A/1V
S2014	Safety fuse adapter, 3 pcs
A1198	Magnetic contact probe

	Temperature/Humidity & Air Pressure Datalogger	Sound Level Datalogger	DC Current or Voltage Datalogger		AC Current & Voltage Datalogger
<b>Code</b>	<b>ST-174B</b>	<b>ST-173</b>	<b>ST-171A</b>	<b>ST-171V</b>	<b>ST-175CV1</b>
<b>Features</b>	<ul style="list-style-type: none"> <li>Manual &amp; Automatic start mode</li> <li>Alarm set-up &amp; indication</li> <li>Recording &amp; low battery indication</li> <li>USB port for data traffic &amp; power</li> <li>Status indication via Red/Yellow &amp; Green LED</li> </ul>	<ul style="list-style-type: none"> <li>Max - Min measurement</li> <li>Alarm value set-up / A&amp;C Weighting</li> <li>Normal &amp; Peak Mode</li> <li>Fast and slow response</li> <li>Manual/Auto Mode</li> </ul>	<ul style="list-style-type: none"> <li>Freely selectable measuring cycle</li> <li>USB Data Download</li> <li>Alarm display if parameters exceeded</li> </ul>		<ul style="list-style-type: none"> <li>True RMS reading</li> <li>USB-PC Interface (c/w software)</li> <li>Single channel input</li> <li>c/w Probes for 1PH, current and voltage measurements</li> </ul>
<b>Ranges</b>	Data memory: 10 000 readings Sampling Rate: 1 min to 18 Hrs Data Output: USB Temp Range: -40 to 70°C / -40° to 158°F Resolution: 0.1°C/0.1°F Humidity Range: 0 to 100%RH Resolution: 0.1%RH Air Pressure: 950 to 1050hPa Resolution: 0.1hPa	Sampling Rate: 1sec - 24hr Accuracy: ±1.4db Freq Range: 31.5Hz to 8kHz Dynamic Range: 50db Level Ranges: Auto: 30db - 130db Time Weighting: Fast(125ms), Slow(1s) Reading Memory: 129920 points for dBA or dBC Data Output: USB Data	Status display: 2 LEDs Current Range: 4 to 20m ADC Accuracy: ±1%/±1Count Memory: 32000 readings Sampling Rate: 2sec - 24hrs	Status display: 2 LEDs DC Voltage Range: 0 to 30VDC Accuracy: ±0.5%+1 Memory: 32000 readings Sampling Rate: 400Hz to 24 hrs	Current: 10 - 200A Voltage: 10 - 600VAC Sampling Rate: 1sec - 24hr Reading Memory: Up to 100 000

## INSTALLATION TEST EQUIPMENT

	Analog Insulation Tester	Digital Insulation Tester	High Voltage 5kV Insulation Tester
	<p>Designed for SANS 10142 Testing</p> 		
Code	<b>2732IN (1000V)</b>	<b>2751IN (1000V)</b>	<b>6305AIN (5000V)</b>
Features	<ul style="list-style-type: none"> <li>• High quality Taut Band movement</li> <li>• Two continuity test ranges on "low ohms"</li> <li>• Compact and lightweight</li> <li>• AC voltmeter with linear scale</li> <li>• Automatic discharge of capacitive &amp; inductive circuit</li> <li>• Live warning and display of external voltage presence</li> <li>• Fuse, air gap, crowbar and overload protected</li> <li>• Low battery consumption</li> <li>• Mirror scale</li> <li>• Push and turn locking switch for continuous and hand free testing</li> </ul>	<ul style="list-style-type: none"> <li>• Timer for test function (count 3-5 minutes)</li> <li>• Automatic circuit discharge</li> <li>• Continuity test with three phases</li> <li>• External voltage warning indication</li> <li>• Fuse protection</li> <li>• Data hold function</li> <li>• Auto power off function</li> </ul>	<ul style="list-style-type: none"> <li>• PI (Polarization Index) indication</li> <li>• DAR (Dielectric Absorption Ratio) indication</li> <li>• Auto-ranging on all insulation ranges</li> <li>• Optical USB to RS-232 data transmission</li> <li>• Visual and audio warning of external voltage presence (<math>\geq 30V_{ac}</math> or <math>\geq 30V_{dc}</math>)</li> <li>• Auto-hold function to freeze reading</li> <li>• Overload protection • Auto-off function</li> <li>• Adjustable testing duration: 1~30 minutes</li> <li>• Displays testing duration for insulation measurement</li> <li>• Data can be downloaded and saved to a PC or transferred for real-time display</li> <li>• 200 measurement results can be saved in the memory and recalled on the display</li> </ul>
Ranges	<p>Insulation Resistance: Test voltage: (DC V) 250V / 500V / 1000V Measuring ranges: 0-100M<math>\Omega</math> / 0-200M<math>\Omega</math> / 0-400M<math>\Omega</math> (<math>\geq 1.0mA</math> SC) Continuity: Measuring range: 3<math>\Omega</math> / 5<math>\Omega</math> (<math>&gt;200mA</math> SC) AC Voltage: 0-600V AC Power source: 1.5V (AA) x 6</p>	<p>Insulation Resistance: Test voltage (DC V): 250V / 500V / 1000V Measuring ranges (auto ranging): 0-20M<math>\Omega</math> / 0-200M<math>\Omega</math> / 0-2000M<math>\Omega</math> (1mA) Continuity: Measuring range: 0-20<math>\Omega</math> / 0-200<math>\Omega</math> / 0-2000<math>\Omega</math> (200mA) AC Voltage: 0-600VAC Power source: 1.5V (AA) x 6</p>	<p>Insulation resistance: Test voltage: 500V / 1000V / 2500V / 5000V Measuring ranges: 1T<math>\Omega</math> / 2T<math>\Omega</math> / 5T<math>\Omega</math> / 10T<math>\Omega</math> Voltmeter: 30~600V AC/DC Power source: 1.5 (C) x 8</p>
	Analog Earth Resistance Tester	3 Wire Earth Resistance Tester	Digital Loop/PSC/Load Tester
			<p>Designed for SANS 10142 Testing</p> 
Code	<b>2705ER</b>	<b>2720ER</b>	<b>2725LP</b>
Features	<ul style="list-style-type: none"> <li>• High quality Taut Band movement</li> <li>• Capable of measuring earth resistance and earth voltage</li> <li>• 2mA measuring current permits the testing of earth resistance without tripping earth leakage current breakers in the circuit under test.</li> </ul>	<ul style="list-style-type: none"> <li>• Capable of measuring earth resistance and earth voltage</li> <li>• 2mA measuring current permits the testing of earth resistance without tripping earth leakage current breakers in the circuit under test.</li> </ul>	<ul style="list-style-type: none"> <li>• Combined prospective short circuit current, loop and load tester</li> <li>• Measures the voltage drop as if 16A was flowing between Line and Neutral</li> <li>• Display voltage as if 16A flowing between Line and Neutral (V at 16A)</li> <li>• Loop test for L-E</li> <li>• PSC between L-N</li> <li>• Single smart push button operation: ON, Scroll through results and menus</li> <li>• Checks wiring integrity (LEDs)</li> <li>• Auto off/auto ranging (software range)</li> </ul>
Ranges	<p>Earth resistance: 0-10<math>\Omega</math> / 0-100<math>\Omega</math> / 0-1000<math>\Omega</math> Earth voltage: 0-30 VAC (40-500Hz) Measuring System: Earth resistance by constant current inverter 820 Hz, 2mA approx. Power source: 1.5V (AA) x 6</p>	<p>Earth resistance: 0-20<math>\Omega</math> / 0-200<math>\Omega</math> / 0-2000<math>\Omega</math> Earth voltage: 0-200 VAC (40-500Hz) Measuring system: Earth Resistance by constant current inverter 820Hz approx. 2mA Power source: 1.5V (AA) x 6</p>	<p>Loop impedance range L-E: 0.03-2000<math>\Omega</math> Test currents in each loop: 11.76A at 230V / 50Hz Voltage measurement: L-N 50 to 280VAC (Sine) Load current for volt drop (L-N): 16A (Calculation) PSC current (L-N) max: 6kA at 230VAC supply Operating voltage: 230V<math>\pm</math>20V at 50Hz Power Source: 1.5V (AA) x 6</p>

## INSTALLATION TEST EQUIPMENT

	Digital Electrical Network Analyzer	Digital RCD/GFCI/ELCB Tester	Digital Earth Leakage Tester
	<p>Designed for SANS 10142 Testing &amp; Fault Finding</p>	<p>Designed for SANS 10142 Testing</p>	<p>Robust Design for Mining Applications</p>
Code	<b>2726NA</b>	<b>2712EL</b>	<b>2820EL</b>
Features	<ul style="list-style-type: none"> <li>Built-in Earth tester (No peg required)</li> <li>Built-in Loop/PSC tester</li> <li>Built-in Voltmeter</li> <li>Built-in Wiring checker</li> <li>One push button smart control</li> <li>Display L-N and L-E voltages</li> <li>Display Line path impedance</li> <li>Display Earth path impedance</li> <li>Display Neutral path impedance</li> <li>Display PSC Line to Neutral</li> <li>Display PSC Line to Earth</li> <li>Re-scroll through previous results</li> <li>Bat. ok/low battery indicator</li> <li>Auto-off function</li> <li>Rugged Case</li> <li>Ultra low power consumption</li> </ul>	<ul style="list-style-type: none"> <li>2 Lines x 16 characters LCD</li> <li>Very low consumption</li> <li>Accurate digital readout of disconnection time</li> <li>Automatic data hold function</li> <li>Over temperature, Over voltage</li> <li>Fuse protection</li> <li>Zero crossing circuitry permits testing start at 0° or 180°</li> <li>Disconnection phase polarity shown on LCD display</li> <li>Auto off and off override</li> <li>Polarity trip indicator (positive or negative phase referenced to earth)</li> <li>Wiring polarity indicator</li> </ul>	<ul style="list-style-type: none"> <li>Checks ELCB trip time &amp; trip point (sensitivity)</li> <li>2 Test types for instantaneous ELCBs or inverse and fixed time delay ELCBs</li> <li>Auto off and auto ranging</li> <li>Start Phase angle selection (0° / 180°)</li> <li>Indicates tripping phase angle</li> <li>Impact resistant enclosure</li> <li>Over temperature shut-down</li> <li>Transient protection</li> <li>Suitable for heavy industrial use</li> <li>Fused</li> </ul>
Ranges	<p>Loop / Earth / Line Impedance: 0.03-2000Ω (auto-ranging)</p> <p>Prospective short circuit (PSC): 0~6kA at 230VAC</p> <p>Operating voltage: 50V~275VAC (50Hz)</p> <p>Best performance at rated voltage: 230VAC ± 20V</p> <p>Voltage Measurement (L-N)(L-E): 50-280VAC (Sine)</p> <p>Power Source: 1.5V (AA) x 6</p>	<p>Operating voltage (L-E) (50Hz or 60 Hz): 230 VAC</p> <p>Current Settings: 3mA, 5mA, 10mA, 15mA, 20mA, 30mA, 50mA, 100mA, 150mA, 250mA, 300mA, 500mA</p> <p>Start phase angle setting: 0° &amp; 180° selectable</p> <p>Over-temperature protection: Yes (3 sensors)</p> <p>Voltmeter (L-E): 20VAC ~ 280VAC (50Hz or 60Hz)</p> <p>Timer resolution: 1ms (Max. Time=2.999s)</p> <p>Timer accuracy: ±2ms</p> <p>Power source: 1.5V (AA) x 6</p>	<p>Trip current: 0-1A at 317VAC / 50Hz</p> <p>Trip current resolution: 1mA</p> <p>Operating voltage: (L-E) 100 - 450V</p> <p>Phase angle setting: 0°&amp;180° selectable</p> <p>Timer-max: 99.999s</p> <p>Timer resolution: 1ms</p> <p>Typical Accuracy:</p> <p>Trip-current: ±1%rdg±1mA</p> <p>Trip-time: ±1%rdg±1dgt</p> <p>Voltage: ±3%rdg±1dgt</p> <p>Power source: 1.5V (AA) x 8</p>

## DIGITAL ELECTRICAL COMPLIANCE TEST CASE



### Electricians Test Case

Electricians electrical compliance test case, instruments required to test for issue of electrical compliance certificates.

Code	CK-1	
Case Includes	<b>2751IN</b>	Digital Insulation Tester (Page 490)
	<b>TEL1-3</b>	RCD Tester (Page 489)
	<b>MY60</b>	Digital Multimeter (Page 483)
	<b>ST-850</b>	Digital Phase Indicator (Page 489)
	<b>MS8900</b>	Voltage Finder (Page 485)
	<b>2726NA</b>	Digital Electric Network Analyser (Page 491)



## INSTALLATION TEST EQUIPMENT

		Digital Insulation Tester		
Code	TIN4D (5kV)	TIN5D (10kV)	TIN5D (10kV)	TIN6D (10kV)
Features	<ul style="list-style-type: none"> <li>• Displays Insulation test time</li> <li>• Displays warning</li> <li>• Fully protected crow bar</li> <li>• Auto ranging</li> <li>• Insulation test time interval up to 99 sec</li> </ul>	<ul style="list-style-type: none"> <li>• Auto Ranging on all Ranges</li> <li>• Display insulation test time</li> <li>• Displays Warning</li> <li>• Fully Protected Crow bar</li> <li>• Insulation test time interval up to 99 sec</li> </ul>	<ul style="list-style-type: none"> <li>• Heavy Duty Carry Case</li> <li>• Silicone test leads</li> <li>• Anti-skid/vibration absorbing enclosure</li> <li>• Live circuit warning</li> <li>• Auto Discharge / Range / Off</li> <li>• Insulation test time interval up to 99 sec</li> </ul>	<ul style="list-style-type: none"> <li>• Heavy Duty Carry Case</li> <li>• Silicone test leads</li> <li>• Anti-skid/vibration absorbing enclosure</li> <li>• Live circuit warning</li> <li>• Auto Discharge / Range / Off</li> <li>• Insulation test time interval up to 99 sec</li> </ul>
Ranges	Insulation test voltages: 500V / 1000V / 2500V / 5000V Insulation Resistance: 0-30GΩ / 0-60GΩ / 0-125GΩ / 0-250GΩ Accuracy: ± 3% reading + 2 Digit Output Current Limit: 50μA to 100μA Live Warning: >500V Power Source: 8 x 1.5V C Batteries Alkaline Standard Accessories: Carry Pouch	Insulation test voltages: 1000V / 2500V / 5000V / 10000V Insulation Resistance: 0-60GΩ / 0-125GΩ / 0-250GΩ / 0-500GΩ Accuracy: ± 3% reading + 2 Digit Output Current Limit: 50μA to 100μA Live Warning: >500V Power Source: 8 x 1.5V C Batteries Alkaline Standard Accessories: Carry Pouch	20 Insulation test voltages: 500V - 10KV Insulation Resistance: 25GΩ - 500GΩ Output power Limit: 1W Accuracy: ± 3% reading + 1 Digit Short Circuit Current: Max 1.25mA Power Source: 8 x 1.5V C Batteries Alkaline Standard Accessories: Carry Pouch	20 Insulation test voltages: 500V - 10KV Insulation Resistance: 25GΩ - 500GΩ Output power Limit: 1W Accuracy: ± 3% reading + 1 Digit Short Circuit Current: Max 1.25mA Power Source: 8 x 1.5V C Batteries Alkaline Standard Accessories: Carry Pouch
		Digital Insulation Tester	Analogue Insulation Tester	
Code	T1851 (1000V)	T1832 (1000V)	T1832 (1000V)	T1800 (1000V)
Features	<ul style="list-style-type: none"> <li>• Live Circuit Indication</li> <li>• Live Circuit Warning</li> <li>• Auto Discharge</li> <li>• AC voltage measurement</li> <li>• Auto Power Off</li> <li>• Continuity Buzzer</li> </ul>	<ul style="list-style-type: none"> <li>• Taut Band Movement</li> <li>• Live Circuit Indication</li> <li>• Auto Discharge</li> <li>• AC voltage measurement</li> <li>• Rugged Construction</li> <li>• Nulling of Test Leads</li> <li>• Continuity Buzzer</li> <li>• Mirror Scale</li> </ul>	<ul style="list-style-type: none"> <li>• Taut Band Movement</li> <li>• Live Circuit Indication</li> <li>• Colour Coded Scale</li> <li>• Auto Discharge</li> <li>• Heavy Duty Carry Case</li> <li>• AC Voltage Measurement</li> </ul>	<ul style="list-style-type: none"> <li>• Taut Band Movement</li> <li>• Live Circuit Indication</li> <li>• Colour Coded Scale</li> <li>• Auto Discharge</li> <li>• Heavy Duty Carry Case</li> <li>• AC Voltage Measurement</li> </ul>
Ranges	Insulation test voltages: 250V / 500V / 1000V Insulation Resistance: 0-200MΩ / 0-2000MΩ (1mA) Accuracy: ± 1.5% reading + 5 Digit Continuity Range: 0-2kΩ (210mA) Voltage Measurement: 0-500VAC Power Source: 8 x 1.5V AA Batteries Alkaline	Insulation test voltages: 250V / 500V / 1000V Insulation Resistance: 0-100MΩ, 0-200MΩ, 0-400MΩ (1mA) Accuracy: ± 5% of Indicated Value Continuity Range: 0-50Ω (200mA) Voltage Measurement: 0-500VAC Power Source: 8 x 1.5V AA Batteries Alkaline	Insulation test voltages: 250V / 500V / 1000V Insulation Resistance: 0-100MΩ, 0-200MΩ, 0-400MΩ (1mA) Accuracy: ± 5% of Indicated Value Continuity Range: 0-50Ω (145mA) Voltage Measurement: 0-500VAC Power Source: 8 x 1.5V AA Batteries Alkaline	Insulation test voltages: 250V / 500V / 1000V Insulation Resistance: 0-100MΩ, 0-200MΩ, 0-400MΩ (1mA) Accuracy: ± 5% of Indicated Value Continuity Range: 0-50Ω (145mA) Voltage Measurement: 0-500VAC Power Source: 8 x 1.5V AA Batteries Alkaline

## INSTALLATION TEST EQUIPMENT

	Digital Earth Resistance Tester	Analogue Earth Resistance Tester	ELCB/Phase Rotation Tester
			
<b>Code</b>	<b>T1820</b>	<b>T1805</b>	<b>TEL11</b>
<b>Features</b>	<ul style="list-style-type: none"> <li>• Earth voltage detection</li> <li>• 2mA earth resistance to test</li> <li>• 2 and 3 Wire Testing</li> </ul>	<ul style="list-style-type: none"> <li>• Large display</li> <li>• Taut band movement</li> <li>• 2 and 3 Wire tester</li> </ul>	<ul style="list-style-type: none"> <li>• 3 Phase presence</li> <li>• 3 Phase rotation</li> <li>• Test for disconnection sensitivity</li> <li>• Test for disconnection time</li> <li>• Select one of 3-phase to test ELCB</li> <li>• Measure voltage phase to earth</li> <li>• Over temperature protection</li> <li>• Phase polarity trip indicator</li> </ul>
<b>Ranges</b>	Resistance: 20Ω, 200Ω, 2kΩ Earth Voltage: 200VAC (40 - 500Hz) Measuring System: Earth resistance by constant current inverter, 820Hz, 2mA Approx Resistance Accuracy: ±2% rdg + 2 Digit Voltage Accuracy: ±1% rdg + 2 Digit Power Source: 8 x 1.5V AA Batteries Standard Accessories: Test Leads, Earth Spikes and Shoulder Belt	Resistance: 10Ω, 100Ω, 1kΩ Earth Voltage: 30VAC (5kΩ/V) Measuring System: Earth resistance by constant current inverter, 820Hz, 2mA Approx Withstand Voltage: 1500VAC (one minute), ±1.8% + 4 Digit Resistance Accuracy: ±2.5% of full scale Voltage Accuracy: ±1% of full scale Power Source: 8 x 1.5V AA Batteries Standard Accessories: Test Leads, Earth Spikes and Shoulder Belt	Phase-start-selection: 0°C and 180°C Current Settings: 1 to 999mA AC Operating Voltage (L-E): 110V AC to 317V AC (525V system) Current Resolution: 1mA Voltmeter Resolution: 1V Maximum Current Consumption: 10mA ELCB Voltage Measurement (L-E) (V AC) : 10 - 550V ELCB Fuse (Slow Blow) Power Source: 8 x 1.5V C Batteries Alkaline Certificate of conformance: Standard Accessories: Test Leads x 2 (terminate own plug)
	<b>Loop/PSC/Load Tester</b>		<b>ELCB Tester</b>
			
<b>Code</b>	<b>T1825 (1000V)</b>	<b>T1826 (1000V)</b>	<b>TEL28 (1000V)</b>
<b>Features</b>	<ul style="list-style-type: none"> <li>• Load/No load tester</li> <li>• Prospective short circuit current (PSC)</li> <li>• Volt drop test</li> <li>• Micro processor controlled</li> <li>• Test up to 100A (6kA) circuit breakers</li> <li>• 3-Phase system test</li> <li>• Designed to SANS 10142</li> </ul>	<ul style="list-style-type: none"> <li>• Fault finding</li> <li>• Electrical network analyser</li> <li>• Earth resistance without peg</li> <li>• Analyse to SANS 10142</li> <li>• Loop test for L-E, L-N and PSC</li> </ul>	<ul style="list-style-type: none"> <li>• Micro-processor controlled</li> <li>• Direct read out of time/current</li> <li>• Voltage measurement</li> <li>• Suitable for industrial, mining and domestic environments</li> <li>• 3 Phase - Each phase tested separately</li> <li>• Designed to SANS 10142</li> </ul>
<b>Ranges</b>	Loop: 0~2000Ω PSC: 0 ~ 6kA @230V(L-N) Operating Voltage: 50 ~275VAC (50 or 60Hz) Test Current: 12A (Load Volts shown as @16A) Power Source: 8 x 1.5V AA Batteries Alkaline Standard Accessories: Carry Case, Strap, Leads	Loop: 0~2000Ω PSC: 0 ~ 6kA @230V (L-N) Operating Voltage: 230VAC ± 20V (50Hz) Test Current: 11.76A Neutral Wire Resistance: 0.01 - 2000Ω Live Wire Resistance: 0.01 - 2000Ω PSC Current (L-N): Max 6kA @ 230V AC PSC Current (L-E): Max 6kA @ 230V AC Power Source: 8 x 1.5V AA Batteries Alkaline Standard Accessories: Carry Case, Strap, Leads	Rated tripping current: 0 to 1000mA, ± 1mA Resolution: 1mA Operating Voltage (L-E): 100 to 450VAC, Maximum Trip Time: 100 secs (1mS resolution), Phase Angle Setting: 0 and 180° selectable Power Source: 8 x 1.5V AA Batteries Alkaline Standard Accessories: Carry Case, Strap, Leads



## 20MHZ HANDHELD DUAL CHANNEL SCOPE METER

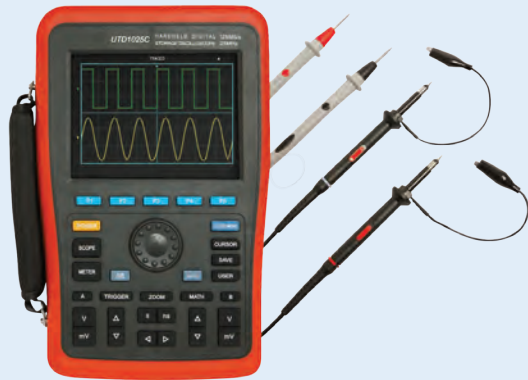

### DMM Functions

DCV/ACV: 600m/6/60/600/1000V(750V),  
±1.0%/1.2%

DCA/ACA: 6/60m/600m/6A, ±1.2% / 2.0%

OHM: 600/6k/60k/600k/6M/60MΩ, ±1.2%

CAP: 6n/60n/600n/6μ/60μ/600μF, ±4.0%

Audible continuity & diode test

### Features

- DMM built with dual-channel DSO, colour LCD display
- Automatic waveform and status configuration
- Edge, Pulse, Video and Alternate triggers
- Waveform maths & FFT, auto & cursor measurement
- Display zone for precision waveform analysis
- Screen copy, waveform recording and replay
- Built-in 6 digits frequency counter
- USB interface, system software upgradeable
- AC power (100~240V, 50/60Hz) or batteries
- Dimensions & weight: 268 x 168 x 60mm, approx 1.8kgs
- Accessories: AC adaptor, interface wire & software, test leads & probes

### Scope Meter

Code	UTD1025C
Bandwidth	DC ~ 25MHz, dual channels
Real-time Sampling Rate	125M Sa/s
Equivalent Sampling Rate	25G Sa/s
Horizontal sensitivity	10ns/div-50s/div, ±0.01%
Record Length	2 x 512k
Vertical sensitivity	5mV/div-5V/div, ±5%
Vertical resolution	8 bit
Rise time	14ns
Trigger type	Edge, Pulse width, Video, Alternate
Max. input voltage	400V DC + AC peak
Input impedance	1MΩ //21pF
Waveform maths	+, -, *, /, FFT
Auto measurement	Vpp, Vmax, Vmin, Vtop, Vbase, Vmid, Vamp, Vavg, Vrms, +Overshoot, -Overshoot, Freq, Period, Risetime, Falltime, +Width, -Width, ±delay, ±duty
Cursor measurement	ΔV, ΔT
Frequency counter	6 digits
Interface	USB2.0 Host
Storage (internal/USB)	10 waveforms + 10 setups
Display	5.7 inch 320 x 240 pixels color LCD

## HIGH VOLTAGE SAFETY GLOVES & MATS

CE Approved



CUST.GI



VPG90

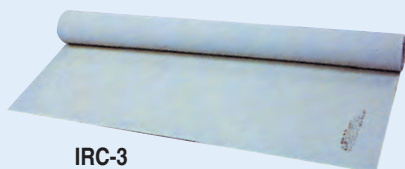

IRC-3

### Safety Gloves

Test V	2500V	5kV	10kV	20kV	30kV
User V	500V	1kV	7.5kV	17kV	26.5kV
Code	Code	Code	Code	Code	Code
8	GI2,5-8	GI5-8	GI10-8	GI20-8	GI30-8
9	GI2,5-9	GI5-9	GI10-9	GI20-9	GI30-9
10	GI2,5-10	GI5-10	GI10-10	GI20-10	GI30-10
11	GI2,5-11	GI5-11	GI10-11	GI20-11	GI30-11

### Accessories

Code	Description
CUST.GI	Protective plastic case for gloves
VPG90	Pneumatic Tester. Inflates the gloves and you can detect perforation on dielectric

26,5kV Insulated Rubber Safety Mat - 3mm thick x 1 m wide – priced per meter

Code	Description
IRC-3	3mm x 1 meter (w). Voltage test 30000V, max use voltage 26500V

## HIGH VOLTAGE TESTERS



### HVD Range - High Voltage Detector

Code	HVD13AC	HVD32AC	HVD33AC
System Voltage	6.6-132kV	11-33kV	44-132kV
Threshold Range*	2.5kV	2.5kV	10kV

#### Technical Overview

Spark Protection	The detector will not be damaged as a result of spark discharge while making contact with the conductor under test
Bridging Protection	The detector and its accessories will not cause flashover between live parts of the installation or between live parts of the installation and earth/ground
Current Consumption	30 mA maximum
Test Button	Tests and arms the detector when pressed and released
Visual Indicator (2Hz)	Red lamp (voltage present), green lamp (safe)
Audible Indicator	Buzzer - 3.1 kHz tone modulated at 2 Hz - 70 dB (1.5 metres)

#### Mechanical

Y Electrode	Material: Stainless Steel. Size (mm): 40Ø x 35L
Standard Accessories	Carry bag, Cleaning kit, Rose Connector, Y Contact

- Checks if HV system is alive or dead
- All weather use (indoor or outdoor)

\* Non standard threshold voltages can be set outside the range to suit customers requirements



### THVD Range - Contact Capacitive High Voltage Detector

Code	T213HVD	T217HVD	T218HVD	T219HVD	T220HVD
System Voltage	11kV	11/33kV	6/22kV	44/132kV	6.6/132kV
Threshold Set within Range	1.65-4.4kV	3.3-4.95kV	1.8-2.7kV	6.6-19.8kV	1.65-14.6kV
Response Time	<1 Sec	<1 Sec	<1 Sec	<1 Sec	<1 Sec
Auto-OFF	±3 Min	±3 Min	±3 Min	±3 Min	±3 Min
Bridging Protection	Yes	Yes	Yes	Yes	Yes
Spark Protection	Yes	Yes	Yes	Yes	Yes
Battery Low	<7V	<7V	<7V	<7V	<7V
Threshold	3.02kV	4.12kV	2.5kV	13.2kV	2.5kV
Battery Current	<30mA	<30mA	<30mA	<30mA	<30mA
Green = Armed	Yes	Yes	Yes	Yes	Yes
Red = V Detected	Yes	Yes	Yes	Yes	Yes

- Self-starting and automatically activated when the High Voltage is applied to the contact electrode
- Use on sinusoidal (50 or 60Hz) High Voltage Systems
- Models are available to cover systems voltage from 6.6kV to 132kV
- IEC 61243-1 for voltages above 1kV 50/60Hz
- Check system is dead or alive



### High-Prox Voltage Proximity Detector

Code	T175HP
Ranges	240V, 3.3kV, 6.6kV, 11kV, 22kV, 33kV, 66kV, 132kV, 275kV
Detection	Selected range is detected at approx. 25cm from the voltage source 240V ±10cm, 33kV ±50cm
Self-Test	Selection
Indicators	Bright Red LED and buzzer

#### Model Specifications

Power Source	3 x 1.5V C Batteries
Standard Accessories	Carry Pouch

- Non-contact high voltage detector
- Ten switch-selectable voltage sensitivity ranges
- Lightweight
- Audible and visual indication of live voltage
- Rose adaptor
- Check high frequency radiation

# HIGH VOLTAGE TEST EQUIPMENT



When approaching a high voltage source the buzzer will sound and LED will flash to alert the user.  
Waterproof Design.

### Personal Safety Voltage Detector

<b>Code</b>	<b>286-SVD</b>
Sensing Distance	800mm @ 11,4kV 50/60Hz
Volume	70dB @ 1m
Size	59 x 56 x 18mm



### High Voltage Proximity Detector

<b>Code</b>	<b>277HP</b>
The <b>277HP</b> is a voltage (non contact) proximity detector for checking for the presence of AC voltages in cables, wall outlets, fuses etc. AC voltages from 50V to 132kV.	
<ul style="list-style-type: none"> <li>• 2 selectable ranges: LOW: 50 - 1.5kV HIGH: 1.5kV - 132kV</li> <li>• Power consumption OFF: Less than 5µA ON: Less than 40mA</li> <li>• Test Button: Test the system prior to measurement</li> <li>• Operating Temperature: 0°C - 40°C</li> <li>• Dimensions (L x W x Ø): 318 x 75 x 71mm</li> <li>• Power Source: 1 x 9V (6F22) battery</li> <li>• Standards: EN61326-1 / EN61000-4-2 / EN61000-4-3</li> <li>• Supplied with: Manual, Battery, Carry case.</li> </ul>	

### Accessories - Hotsticks



<b>Code</b>	<b>Description</b>
<b>HS-*</b>	Meets IEC 60855 Rated at 100kV per 300mm / 5 minutes

\*Add Length to Code: **120** = 1200mm long,  
**800** = 800mm long, **500** = 500mm long

### Disconnect Hook



**HOK-HS166**

### Fuse Extractor



**ADP-HS120**

### High Voltage Multifunction Phasing Sticks



Specifications	PC-7K	PC-11K	PC-22K	PC-33K	PC-44K
System Voltage	6.6kV	11kV	22kV	33kV	44kV
Full Scale Voltage	8kV	12kV	24kV	35kV	48kV
Maximum Voltage	9kV	15kV	30kV	40kV	55kV
Total Resistance	3.95MΩ	6.78MΩ	13.5MΩ	20.1MΩ	27MΩ
Neon Threshold	1.2kV	1.2kV	1.2kV	1.2kV	1.2kV
Neon Fully lit @	1.5kV	1.5kV	1.5kV	1.5kV	1.5kV
Handle Length	775mm	775mm	765mm	765mm	765mm
Front End Length	400mm	400mm	460mm	610mm	760mm
Total Length	1105mm	1105mm	1225mm	1375mm	1525mm
Total Weight	±1.2kg	±1.2kg	±1.3kg	±1.4kg	±1.5kg
Handle Material	Silicone, Front end: Fibre glass wound tubing				
Operating Temperature	-25°C to +55°C				
Operating Humidity	20 to 96% RH				

- Lightweight, Robust
- No user assembled parts
- Self-powered - No Battery
- Designed for maximum safety
- Dual colour coded scale
- Grounded or ungrounded systems
- Carry case included
- Measure & test phase to earth & phase to phase
- High immunity to interference fields

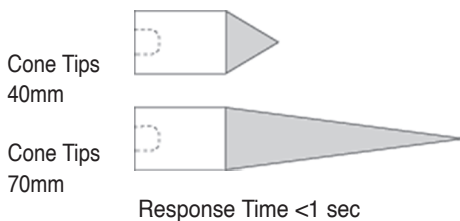

### Accessories - (for all models)

<b>Code</b>	<b>Description</b>
<b>PC-BK</b>	90° bends (pair)
<b>PC-C1K</b>	40mm cone tips (pair)
<b>PC-C2K</b>	70mm cone tips (pair)



**RMB36**  
c/w case

### Phasing and Voltage Detector of MV Presence / Absence by Visual Signalling (Indoor Use)

<b>Code</b>	<b>Description</b>
<b>RMB36</b>	<ul style="list-style-type: none"> <li>• Double pole voltage detector</li> <li>• Phase relationship detector</li> <li>• HV fuse tester</li> <li>• Operating range: 5/36 kV</li> <li>• Total length of each rod complete with antenna: 1,17m</li> </ul>

## HIGH VOLTAGE TEST EQUIPMENT

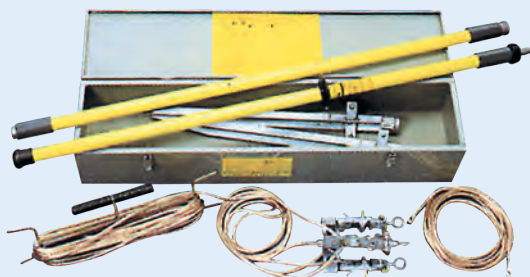

### Short Circuiting and Grounding

Short circuiting and grounding equipment for electrical cabinets and MV installations with universal contact clamps

Code	Description
MT/BM-25	Standard type. lcc: 13,7kA eff / 0.25s With short circuit cables section 25mm <sup>2</sup>
MT/BM-50	With short circuit cables section 50mm <sup>2</sup> lcc: 13kA eff / 0.5s
MT/BM-95	With short circuit cables section 95mm <sup>2</sup> lcc: 24kA eff / 0.5s

Certificate complies to the International Standard CEI EN 61230 (CEI IEC 1230)



### Fuse Extraction Rod

Code	EF30
Description	Insulating Rod for fuse extraction and installation on systems with working voltages up to 30kV

## VOLTAGE TESTERS

	Screw Driver Type		Continuity & Non-Contact	Advanced Non-Contact	Analogue
<b>Code</b>	<b>BESTEST 7</b>	<b>BESTEST 18</b>	<b>TESTBOY20</b>	<b>MD-116</b>	<b>901</b>
Safety Rating	—	—	Cat II 300V	Cat IV 1000V	Cat III 750V
Test Voltage AC	200 - 250VAC	100 - 500VAC	0 - 300VAC	12V - 1000VAC	120 - 750V AC/DC
Indication	Neon	LED	Buzzer / LED	Optical, Acoustic, Vibrating	Neon / Analogue Scale
Non Contact V	No	Yes	Yes	Yes	No
Features	<ul style="list-style-type: none"> <li>Contact test to earth</li> <li>With pocket clip</li> </ul>	<ul style="list-style-type: none"> <li>With pocket clip</li> <li>Non-contact test</li> <li>Continuity check: 0 - 50MΩ</li> <li>DC polarity check 1.2 - 36VDC</li> </ul>	<ul style="list-style-type: none"> <li>Non-contact voltage detector (&gt;110VAC)</li> <li>High performance LED torch</li> <li>Continuity indication via lamp or buzzer</li> <li>1 pole phase detection</li> </ul>	<ul style="list-style-type: none"> <li>With pocket clip</li> <li>Integrated LED flashlight</li> <li>Low / high sensitivity</li> <li>Three indication methods</li> </ul>	<ul style="list-style-type: none"> <li>Double insulated Handles</li> <li>Neon indication of voltage presence</li> <li>Clearly legible analogue scale</li> <li>DC polarity indication</li> </ul>

### LED Bargraph Display

### Voltage & Continuity

<b>Code</b>	<b>MV-400</b>	<b>BESTEST 8</b>	<b>GK12A</b>	<b>MD-1060</b>	<b>MD-1160</b>
Safety Rating	CAT III 600V	CAT II 500V	Cat III 1000V, Cat IV 600V	Cat IV 600V	Cat IV 600V
Test Voltage	6 - 400V AC/DC	12 - 690V AC/DC	10 - 690V AC/DC	12V - 690V AC/DC	0V - 690V AC/DC
Indication	LED	LED	LED	Acoustic / LED	Acoustic / LCD
Features	<ul style="list-style-type: none"> <li>DC polarity indication</li> </ul>	<ul style="list-style-type: none"> <li>Test Earth leakage CB</li> <li>Continuity / Semi-conductor test 0 - 1MΩ battery powered</li> <li>DC polarity indication</li> <li>1 pole phase testing</li> </ul>	<ul style="list-style-type: none"> <li>Continuity / Diode Test (&lt;200kΩ)</li> <li>Phase Rotation Test</li> <li>Single pole phase testing</li> <li>LED Worklight</li> </ul>	<ul style="list-style-type: none"> <li>Continuity Buzzer &amp; LED: 0 - 500KΩ + 50%</li> <li>Auto AC/DC recognition</li> <li>Rotary Field Testing</li> <li>Indication of extra low voltage</li> </ul>	<ul style="list-style-type: none"> <li>Continuity Buzzer &amp; LED: 0 - 500KΩ + 50%</li> <li>Auto AC/DC recognition</li> <li>Rotary field testing</li> <li>Indication of extra low voltage</li> <li>LED Work Light</li> <li>2 pole phase sequense</li> <li>Single pole phase testing</li> </ul>



## TEST EQUIPMENT

	DIY Electronic Test Kit	Magnetic Field Tester	Circuit Breaker Identifier
<b>Code</b>	<b>ETK03C</b>	<b>AC-8M</b>	<b>191CBI</b>
Features	<p><b>GK7</b> Non-contact voltage tester with LED and audio alarm; Voltage Range: 50 - 1000VAC 50 - 500Hz</p> <p><b>EM306B</b> Digital Clamp Meter, Continuity Test, Diode Check, Data Hold, Voltage Range: 600V AC/DC, AC Current 20 - 400A, Resistance: 2kΩ - 200kΩ, Jaw Size: 27mm</p> <p><b>DT830</b> Digital Multimeter; Continuity Test, Diode Check Voltage range: 200mV - 250VDC / 200mV - 250VAC, Current Range: 200μA - 10ADC, Resistance: 200Ω - 2MΩ</p>	<ul style="list-style-type: none"> <li>• Testing solenoids &amp; relays</li> <li>• Illuminates when a magnetic field is present</li> <li>• No metallic contact required</li> <li>• Responds to AC and DC magnetic fields and permanent magnets</li> </ul>	<ul style="list-style-type: none"> <li>• Easy tool to find a circuit breaker or fuse without disconnecting the supply</li> <li>• Plug the transmitter into the outlet socket, use the receiver to scan the distribution board or panel to find the correct circuit breaker supplying power to socket</li> </ul>

## CABLE TESTING/TRACING

	Wire Tracer	Multi-Purpose Wire Tester	Network Test Kit	Network Cable Tester
<b>Code</b>	<b>162CB</b>	<b>183CB</b>	<b>ETK05D</b>	<b>KT-201</b>
Features	<ul style="list-style-type: none"> <li>• Trace cables within a group without damaging insulation</li> <li>• Volume Control</li> <li>• 50/60Hz filter</li> <li>• Auto Off function &amp; Flashlight</li> <li>• Continuity Tester</li> <li>• Polarity Tester</li> <li>• LED Indication</li> <li>• Frequency 1kHz</li> <li>• c/w Batteries/Pouch</li> </ul>	<ul style="list-style-type: none"> <li>• Trace cables or wires</li> <li>• Volume Control</li> <li>• Voltage free continuity and polarity testing</li> <li>• Tip &amp; Ring Identification</li> <li>• LED Indication</li> <li>• Detect AC/DC Voltages</li> <li>• Test capacitors &amp; diodes</li> <li>• Frequency: 1kHz</li> <li>• c/w Batteries/Pouch</li> </ul>	<p>5 Piece Kit includes:</p> <ul style="list-style-type: none"> <li>• Carry case</li> <li>• <b>EM415:</b> Wire/Cable Tracer</li> <li>• <b>EM416</b> Network Tester (RJ12 or RJ45)</li> <li>• <b>BT1:</b> Battery tester for 9V</li> <li>• Ratchet Crimpers</li> <li>• Punch Down Tool</li> <li>• Batteries included</li> </ul>	<ul style="list-style-type: none"> <li>• Test range: 300m (L)</li> <li>• Accuracy: ±5%</li> <li>• Resolution: 0.1m</li> <li>• 16 x 2 LCD characters</li> <li>• Cable Continuity</li> <li>• Suitable for computer network systems</li> <li>• <b>Warning: Do not use on live circuits</b></li> </ul>

	UTP/STP Cable Tester	Voltage / Metal / Wood Detector	5 in 1 Detector & Distance
<b>Code</b>	<b>KT-200</b>	<b>MVS-168A</b>	<b>EM60</b>
Features	<ul style="list-style-type: none"> <li>• Test UTP and STP wiring of T568A, T568B, 10Base-T, 100Base-T and Token ring network</li> <li>• Tests for open circuits, shorts, miswires, reversals, split pairs and cable's shield integrity</li> <li>• DEBUG mode quickly identifies which cable pairs have a specific wiring fault</li> <li>• Warning: do not use on live circuits</li> <li>• <u>Cable length specifications</u></li> <li>• Min UTP/STP cable length for testing – 1m</li> <li>• Max UTP/STP cable length for testing – 200m</li> </ul>	<p><u>Detection:</u></p> <ul style="list-style-type: none"> <li>• Stud - Wood stud 30 x 30mm: ≤10mm</li> <li>• Metal - Copper pipe dia.15mm: ≤24mm</li> <li>• AC:90 - 250VAC @ 50 - 60Hz: ≤35mm</li> <li>• Sensitivity can be adjusted</li> <li>• Can be used to accurately detect the position of pipes, AC voltage and wooden studs</li> <li>• Battery: 9V included</li> </ul>	<ul style="list-style-type: none"> <li>• Distance Measurement: 0.4 - 18m</li> <li>• Accuracy: approx. 0.5% + 1 digit</li> <li>• Resolution: 0.01 meters</li> <li>• <u>Detection:</u></li> <li>• Stud - Wood Stud 30 x 30mm: ≤14mm</li> <li>• Metal - Iron pipe dia.20mm: ≤25mm</li> <li>• AC: 90 - 250VAC @ 50 - 65Hz: ≤5cm</li> <li>• Calculates area, volume &amp; does computation of distance</li> <li>• Size: 160 x 64 x 46mm • Battery: 9V incl</li> </ul>



## TEST EQUIPMENT

	Automotive Current Tester		Battery Testers		
	<p>Maxi-Blade</p>	<p>Mini-Blade</p>			
Code	CF-02	CF-02S	BT-12	AT-953	BT-6
Features	<ul style="list-style-type: none"> <li>Measuring Range: 20A@48V AC/DC (10 Sec max)</li> <li>Resolution: 10mA</li> <li>Cable length: 75cm</li> <li>Plugs straight into automotive fuse holder in car</li> </ul>		<ul style="list-style-type: none"> <li>12VDC battery analyser</li> <li>Voltage Test: 8 - 25VDC</li> <li>On Load Battery Test (Evaluates battery's ability to crank engine)</li> <li>Charging system test</li> <li>Starter motor test</li> </ul>	<ul style="list-style-type: none"> <li>Battery Tester</li> <li>Car lighter plug</li> <li>5 indicators: Low / Fair / Normal / Full &amp; Over</li> </ul>	<ul style="list-style-type: none"> <li>3in1 Battery / Bulb / Fuse Tester</li> <li>To test battery types: AA, AAA, C, D, 9V, E, I, SV &amp; PV</li> </ul>
CO Analyser		Coating Thickness Tester		Sound Level Calibrator	
Code	TES-1372		TESTBOY70		SC-05
Features	<ul style="list-style-type: none"> <li>CO Range: 0 - 900ppm (CO)</li> <li>Max hold with time stamp</li> <li>Alarm level setting &amp; replaceable sensor</li> <li>Automatic zero on start-up</li> <li>Accuracy <math>\pm 5\%</math> of reading or <math>\pm 2</math>ppm (whichever is greater)</li> <li>Auto power off &amp; back-light for display</li> </ul>		<ul style="list-style-type: none"> <li>Range: 0 - 1000<math>\mu</math>m/ 0 - 40mil</li> <li>c/w two probes</li> <li>Measures non-magnetic coatings on steel or iron</li> <li>Also measures insulating coatings on non-magnetic metals</li> </ul>		<ul style="list-style-type: none"> <li>94db and 114db calibration at 1kHz</li> <li>Accurate &amp; simple to use</li> <li>Fits 1/2inch diameter microphone</li> <li>Output Frequency: 1000HZ, <math>\pm 4\%</math></li> <li>Reference Temp: <math>&gt;23^{\circ}\text{C}</math> (<math>73^{\circ}\text{F}</math>)</li> <li>Relative humidity: <math>&gt;35\%</math>RH</li> <li>Atmospheric Pressure: <math>&gt;1013</math>mbar (760mm of Hg)</li> <li>Accuracy of sound pressure level under stated reference conditions <math>\pm 0.5</math>db</li> </ul>

## SIMULATORS & THERMOCOUPLES

	4-20mA Simulator	K & J Simulators		Bead Probe	Immersion Probe	Surface Probe
Code	603	601K	601J	TPK-01	TPK-03	TPK-04
Features	<ul style="list-style-type: none"> <li>Ideal for calibration standard &amp; used as a current source.</li> </ul>	<ul style="list-style-type: none"> <li>Checking K type thermocouples and calibrating process indicators / controllers</li> <li>Accuracy: <math>\pm 0.5^{\circ}\text{C}</math> (<math>+1^{\circ}\text{F}</math>)</li> </ul>	<ul style="list-style-type: none"> <li>Checking J type thermocouples and calibrating process indicators / controllers</li> <li>Accuracy: <math>\pm 0.5^{\circ}\text{C}</math> (<math>+1^{\circ}\text{F}</math>)</li> </ul>	<ul style="list-style-type: none"> <li>Bead Probe</li> <li>1.2m long wire has an industry standard mini connector plug</li> <li>Measure surface or air temperature</li> </ul>	<ul style="list-style-type: none"> <li>Immersion Probe</li> <li>General purpose needle type with stainless sheath</li> </ul>	<ul style="list-style-type: none"> <li>Surface Probe</li> <li>Ideal for measuring the surface temp. of small electronic parts.</li> <li>Fast Response</li> </ul>
Ranges	Current: 4mA, 12mA & 20mA Voltage: 9VDC	0 $^{\circ}\text{C}$ (32 $^{\circ}\text{F}$ ) 100 $^{\circ}\text{C}$ (212 $^{\circ}\text{F}$ ) 500 $^{\circ}\text{C}$ (932 $^{\circ}\text{F}$ ) 1000 $^{\circ}\text{C}$ (1832 $^{\circ}\text{F}$ )	0 $^{\circ}\text{C}$ (32 $^{\circ}\text{F}$ ) 100 $^{\circ}\text{C}$ (212 $^{\circ}\text{F}$ ) 200 $^{\circ}\text{C}$ (392 $^{\circ}\text{F}$ ) 400 $^{\circ}\text{C}$ (752 $^{\circ}\text{F}$ )	Temperature: 0-260 $^{\circ}\text{C}$ (500 $^{\circ}\text{F}$ )	Temperature: 0-800 $^{\circ}\text{C}$ (1472 $^{\circ}\text{F}$ )	Temperature: 0-800 $^{\circ}\text{C}$ (1472 $^{\circ}\text{F}$ )



## TEST EQUIPMENT

	Humidity & Temp Meters	Infrared Thermometers		Pen Type Thermometers		
		Pocket size 		Temperature & Humidity 	Temperature Only 	
<b>Code</b>	<b>ST-612</b>	<b>IR-88</b>	<b>IR-99</b>	<b>ST-132</b>	<b>ST-133</b>	
<b>Features</b>	<ul style="list-style-type: none"> <li>Data &amp; max hold</li> <li>T1-T2 modes</li> <li>Dual thermocouple input</li> <li>Scan function</li> <li>User selectable °C or °F</li> </ul>	<ul style="list-style-type: none"> <li>Laser targeting</li> <li>Data &amp; max hold</li> <li>Auto Power Off</li> <li>User selectable °C or °F</li> </ul>	<ul style="list-style-type: none"> <li>(3 in 1) IR Thermometer with Thermistor Probe and clamp</li> <li>User selectable °C or °F</li> <li>Data Hold and Auto Power Off</li> <li>Max, Min record.</li> </ul>	<ul style="list-style-type: none"> <li>Measures temp &amp; humidity</li> <li>Min/Max Hold</li> <li>Auto power off</li> </ul>	<ul style="list-style-type: none"> <li>Measures temp only</li> <li>Auto power off</li> <li>Display in either °C or °F</li> <li>Data Hold</li> <li>LCD Display</li> </ul>	
<b>Ranges</b>	Temperature: -50 to 1300°C K-Type Included Large Display	Temperature: -20 to 270°C Optical Resolution: 6:1 Emissivity: Fixed at 0.95% Response time: <1 sec	Temperature: IR: -35 to 260°C Optical Resolution: 1:1 Emissivity: 0.1-1 (Adj.) Probe: -40 to 260°C Clamp: -40 to 200°C Response time: <1 sec	Temperature: -30 to 50°C Humidity: 30%-95%RH	Temperature: -50 to 300°C (± 1°C / 1°F) Length: 245mm	
	<b>pH/ORP/mV Temperature Meter</b>		<b>pH Meter Kit</b>		<b>Pen Type pH Tester</b>	<b>Moisture Meter</b>
		IP57 			Complete Kit 	
<b>Code</b>	<b>7011</b>	<b>MP-103</b>	<b>PP201</b>	<b>PH5011A</b>	<b>EM4807</b>	
<b>Features</b>	<ul style="list-style-type: none"> <li>Large LCD Display</li> <li>Rugged Design</li> <li>Floats on Water</li> <li>Max/Min/Data Hold</li> </ul>	<ul style="list-style-type: none"> <li>Large LCD Display</li> <li>Splash Proof Housing &amp; Magnet for Handsfree Operation</li> <li>Auto or Manual Temperature Compensation</li> <li>Auto Power Off</li> </ul>	<ul style="list-style-type: none"> <li>Large LCD Display</li> <li>Rugged Design</li> <li>Auto Power Off</li> </ul>	<ul style="list-style-type: none"> <li>Fast Response</li> <li>High Accuracy</li> <li>Splash Proof</li> <li>Extendable Electrode: 90mm</li> </ul>	<ul style="list-style-type: none"> <li>Measure moisture level in paper/cardboard, wood &amp; hardened material (mortar/concrete/plaster).</li> <li>Measure ambient temp.</li> <li>Built in torch.</li> </ul>	
<b>Ranges</b>	ORP Range: -1000 - 1000mV PH Range: 0 - 16 ATC Range: 0 - 90°C Calibration pH: 4.00, 7.00, 10.01 Temp Range: 0 - 90°C (°C / °F)	ORP Range: ± 1999mV PH Range: 0 - 14 ATC Range: 0 - 100°C Calibration pH: 4.00, 7.00, 10.00 Temp Range: 0 - 100°C (°C / °F)	PH Range: 0 - 14 ATC Range: 0 - 100°C Calibration pH: 4.00, 7.00, 10.00	PH Range: 0 - 14 ATC Range: 0 - 100°C	Wood: 6-42% Resolution: 1% Building Material: 0.2-2% Temperature: 0-40°C/ 32-99°F	
<b>Accessories</b>	PH Probe: <b>7000EP4</b> ORP Probe: <b>7000EO</b> Buffer Solution 4.00 (50cc): <b>B-4</b> Buffer Solution 7.00 (50cc): <b>B-7</b>	ORP Probe: <b>MP-103-ORP</b> Buffer Solution 4.00 (50cc): <b>B-4</b> Buffer Solution 7.00 (50cc): <b>B-7</b>	Buffer Solution 4.00 (50cc): <b>B-4</b> Buffer Solution 7.00 (50cc): <b>B-7</b>	Buffer Solution 4.00 (50cc): <b>B-4</b> Buffer Solution 7.00 (50cc): <b>B-7</b>	-	

## THERMAL IMAGING CAMERAS

### Compact Range - Thermal Imaging Cameras for your Smart Phone

Made for iPhone® and Android™ top models, Seek Compact transforms your smartphone or tablet into a professional thermal imaging tool. By utilizing the power and convenience of your smartphone, our cameras make it easy to take thermal photos and video, share findings, and send for documentation. Simply connect and detect energy loss caused by air leaks, missing or damaged insulation, inefficient HVAC systems, electrical faults, and much more. On top of all this, Seek Compact cameras are engineered to run on low power from your smartphone and do not require batteries or charging.

	Compact Thermal Camera	CompactXR Thermal Camera	CompactPRO Thermal Camera
			
<b>Android™ Code</b>	<b>ST-COMPACT-A</b>	<b>ST-COMPACTXR-A</b>	<b>ST-COMPACTPRO-A</b>
<b>iPhone® Code</b>	<b>ST-COMPACT-I</b>	<b>ST-COMPACTXR-I</b>	<b>ST-COMPACTPRO-I</b>
<b>Features</b>	<ul style="list-style-type: none"> <li>• Easy to Use Indoor Versatility. Wide field of view quickly scans the inside of any room</li> <li>• High-Performance Thermal Sensor accurately identifies areas of heat loss and gain</li> <li>• Best in Class Temperature Range</li> <li>• Customize, Record and Share Intuitive, free mobile app available on Google Play and iTunes App Store</li> <li>• Focusable Lens for Quick Identification</li> <li>• Comes with its own waterproof case</li> </ul>	<ul style="list-style-type: none"> <li>• Built for Long-Range Detection. Narrow field of view quickly scans up to 550 meters</li> <li>• High-Performance Thermal Sensor accurately identifies heat signatures</li> <li>• Best-in-Class Temperature Range</li> <li>• Customize, Record and Share Intuitive, free mobile app available on Google Play and iTunes App Store</li> <li>• Focusable Lens for Quick Identification</li> <li>• Comes with its own waterproof case</li> </ul>	<ul style="list-style-type: none"> <li>• High-Resolution Thermal Sensor 76,800 temperature pixels for maximum image clarity and sensitivity</li> <li>• Adjustable Emissivity. Calibrate for reflective surfaces when accuracy is critical</li> <li>• Span &amp; Level: Isolate and capture the thermal details that matter</li> <li>• Wide, 32-Degree Field of View Easily scan a large area to identify potential hazards in seconds</li> <li>• Focusable Lens for Quick Identification</li> <li>• Utilizes the Power and Display of Your Smartphone. Intuitive, free mobile app available on Google Play and iTunes App Store</li> <li>• Comes with its own waterproof case</li> </ul>
<b>Specifications</b>			
Thermal Sensor	206 x 156	206 x 156	320 x 240
Detection Distance	300 Meters	550 Meters	550 Meters
Field of View	36°	20°	32°
Temperature Range	-40°C to 330°C	-40°C to 330°C	-40°C to 330°C
Frame Rate	<9Hz	<9Hz	<15Hz FastFrame
Temp. Display Scale	Fahrenheit or Celsius	Fahrenheit or Celsius	Fahrenheit or Celsius or Kelvin
Colour Palettes	9 Options	9 Options	9 Options
Consumption	Up to 280mW	Up to 280mW	Up to 280mW

#### Accessories



**ST-BLAKE-CLIP**



**ST-COMP-CABLE**

Code	Description
<b>ST-BLAKE-CLIP</b>	1/4" threaded tripod mounting bracket for Seek Compact range
<b>ST-COMP-CABLE</b>	USB cable for connection of Seek Compact range to PC

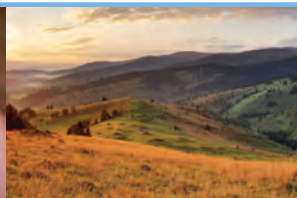
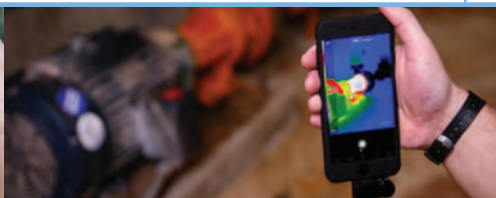

Electrical Maintenance

Wildlife Management

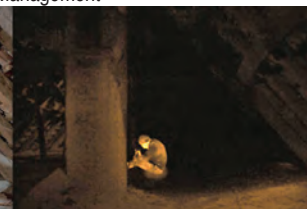
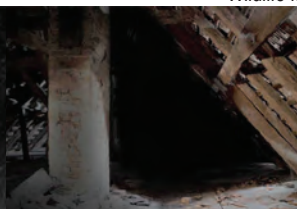
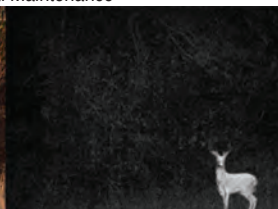
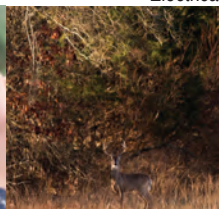

Hunting Applications

Security or Rescue Applications



## THERMAL IMAGING CAMERAS

Powerful and rugged in design, the standalone Seek Reveal combines high-resolution thermal imaging, a long-lasting rechargeable battery, and a large color display in one durable device. And when you need it, Reveal's powerful 300-lumen LED light is available at the touch of a button. Seek Shot is the most advanced thermal imaging camera for building professionals. Snap photo and video and analyze immediately with new on-board thermography tools. Add spot measurements and temperature boxes to create time-saving reports on the spot. Take full control of photos and video by adjusting the blend between visible and thermal images. Share and stream to any smartphone or tablet over WiFi.

	Thermal Sensor with LED Flashlight	Reveal Thermal Imager	RevealPRO Thermal Imager	Reveal Shot Range IP54	
Code	REVEAL XR	ST-REVEAL	ST-REVEALPRO	ST-SHOT	ST-SHOTPRO
Features	<ul style="list-style-type: none"> <li>Built for Long-Range Detection</li> <li>High-Performance Thermal Sensor</li> <li>Smooth Viewing with FastFrame</li> <li>Best-in-Class Temperature Range</li> <li>Long-Lasting Rechargeable Battery</li> <li>See Through the Dark. Light Optional.</li> </ul>	<ul style="list-style-type: none"> <li>Wide field of view quickly scans the inside of any room</li> <li>Best-in-Class Temperature Range</li> <li>Up to 10hrs of continuous thermal imaging on a single charge</li> <li>Intuitive Software Continuous feature enhancements</li> </ul>	<ul style="list-style-type: none"> <li>High-Resolution Thermal Sensor</li> <li>Rugged, rubberized casing with Corning® Gorilla® Glass</li> <li>Continuous Digital Zoom up to 4X</li> <li>Up to 4 hours of thermal imaging in Normal MODE</li> <li>Level and span controls let you isolate and capture the details that matter</li> <li>Adjustable Emissivity. Calibrate for reflective surfaces when accuracy is critical</li> </ul>	<ul style="list-style-type: none"> <li>More pixels, more precision - more resolution than the competition. Best in class thermal resolution</li> <li>SeekFusion™ Technology - See exactly what you're looking at with combined visible thermal images</li> <li>Large colour touch Screen - 3.5" with 640x480 resolution</li> <li>Wi-Fi live view - Stream a live thermal view onto your smartphone or tablet</li> <li>Up to 4hrs continuous thermal imaging</li> <li>3 Customisable spot temperatures</li> <li>3 Customisable area boxes</li> <li>Adjustable span &amp; emissivity</li> </ul>	
Specifications					
Thermal Sensor	206 x 156	206 x 156	320 x 240	206 x 156	320 x 240
Detection Distance	275 Meters	150 Meters	550 Meters	-	-
Field of View	20°	36°	32°	36°	57°
Temperature Range	-40°C to 330°C	-40°C to 330°C	-40°C to 330°C	-40°C - 330°C	
Frame Rate	>15 Hz FastFrame	<9Hz	>15 Hz FastFrame Normal MODE	<9Hz	
Flashlight	300 Lumen LED	300 Lumen LED	300 Lumen LED	Light / Flash	
Temp. Display Scale	Fahrenheit or Celsius	Fahrenheit or Celsius	Fahrenheit, Celsius or Kelvin	Fahrenheit, Celsius or Kelvin	
Colour Palettes	7 Options	7 Options	9 Options	8 Options	
Storage Media	MicroSD Card Included	MicroSD Card Included	4GB Internal Drive	4GB Internal Drive	



### Accessories

Code	Description
ST-VELCRO-1	Holster Bag with Velcro for Seek Reveal range
ST-DRING-1	Attach your Seek Reveal D-Ring to any retractable lanyard (not incl.)



Visible Image

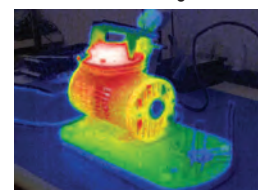

SeekFusion™ Image

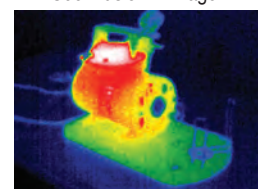

Thermal Image



Security Surveillance

Industrial Surveillance

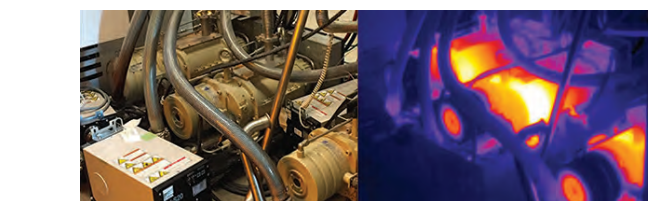

Failing Pumps/Motors



Thermal Image, Corroded Fuse



## ELECTRONIC EDUCATIONAL EQUIPMENT

### Advanced Solderless Breadboards

The best tool to complete the prototyping & testing for your electronic circuits

- Body material ABS
- Interconnection Clips material Alloy of Silver and Nickel
- Easy combination & Expandable

WHILE STOCKS LAST



AD101



AD102



AD11

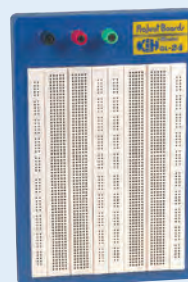

GL-24



UIB-34

Code	Dimensions L x W x H	Tie-Points	Interconnected		24 Clip	5 Connected Term	25 Connected Bus	IC Capacity 14 Pins	Binding Post	Back-Plate
			6 Clip	12 Clip						
AD101	81 x 52 x 9	408	60	2	1	–	–	–	0	Sticker
AD102	81 x 62 x 9	456	60	4	2	–	–	–	0	Sticker
AD11	83 x 147 x 19	958	142	4	2	–	–	–	5	Sticker
UIB-34	230 x 255 x 20	2320	–	–	–	384	16	27	4	Plastic Stand
GL-24	224 x 150 x 20	1680	–	–	–	256	16	18	3	Plastic Stand

#### Accessories

**Code**      **PSB-01**

- Power supply c/w all cables and 5DC output wires
- Short circuit proof
  - DC output
    - (1) DC + 5V, 1A – 5V, 500mA. Fixed
    - (2) DC 0 to + 15V, 500mA Variable
    - (3) DC 0 to – 15V, 500mA Variable
  - AC output
    - (1) AC voltage: 12V-6V-0V-6V-12V, 60mA Fixed



PSB-01



SWS-01



SWS-02



LP-540H

Code	Description
SWS-01	Wire set with banana socket
SWS-02	Wire set without banana socket
LP-540H	Logic Pulser

## SCHOOL PROJECT KIT

NEW



SPK - BUZZER



SPK - ELMAG



SPK - LAMP

Code	SPK - BUZZER	SPK - ELMAG	SPK - LAMP
Description	Starter kit with main components for project. Educational purpose. Great for projects involving sources & electrical circuit.	Starter kit suitable for projects used in natural science & technology. Hands on experimentation. supports learning about electrical & Lighting	Starter kit with main components for school science project. offers hands on approach to understanding electronics & physics.
Features	9V Battery dip with tails Energiser max batteries (9V 6LR61) Buzzer (6-16VDC) Ripcord (W) Hanging bag Latching pushbutton (1 Amp)	Battery holder with tails Energiser max batteries (AA 1.5V LR6) Ripcord (W) 0.2 X 300mm Cut wire (CB) 0.5 X 500mm Hanging bag Latching pushbutton (1 Amp)	Battery holder with tails Energiser max batteries (AA 1.5V LR6) LED 8mm (high bright white) Ripcord (W) 0.2 X 300mm Hanging bag Latching push button (1 Amp)

## DISPLAY UNITS & CABINETS

These Display Units are available on placing of Stock Orders worth a minimum Rand Value.  
Please contact the Tools Product Specialist for more details.

			
			Desk Top Display
<b>Code</b>	<b>AC/DC DISPLAY CABINET</b>	<b>AC/DC DISPLAY CABINET-1</b>	<b>AC/DC DISPLAY CABINET-2</b>
<b>Description</b>	<b>Choice of 3 variations:</b> 1. Hand tools and meters 2. Power tools 3. Combination of 1 & 2	Large display cabinet containing a selection of Mastech products	Small display cabinet containing a selection of Mastech products
<b>Size</b>	1200(W) x 440(D) x 2000(H)	600(W) x 380(D) x 1800(H)	600(W) x 380(D) x 800(H)





## LASER LEVELS & LINE GENERATORS



				
<b>Code</b>	<b>LD-SL08</b>	<b>LD-LS10</b>	<b>LD-LS12</b>	<b>LD-LS15</b>
<b>Description</b>	Self levelling laser	Three laser line generator	Laser line generator	Mini laser level
<b>Accuracy</b>	0.5mm per meter	± 1mm per meter	± 2mm per meter	± 2mm per meter
<b>Features</b>	<ul style="list-style-type: none"> <li>Adjustable base</li> <li>Lock system with on/off switch</li> <li>635nm laser generator</li> </ul>	<ul style="list-style-type: none"> <li>Self leveling</li> <li>3 Directional beams</li> </ul>	<ul style="list-style-type: none"> <li>Ultra compact</li> <li>Vertical &amp; horizontal level</li> </ul>	<ul style="list-style-type: none"> <li>Magnetic base with mini tripod</li> </ul>
			<b>Laser Spirit Levels (with horizontal laser beam/cross line)</b>	
				
			<b>LS8-1</b>	<b>LS7</b>
			Standard	Electronic Inductive
				
<b>Code</b>	<b>LD-SC2</b>	<b>LD-SL01</b>	<b>LD-LS05JD</b>	<b>LD-LS03S</b>
<b>Description</b>	Rotary laser	Self levelling laser	Angle finder with laser	Laser level with magnetic base
<b>Accuracy</b>	± 5mm per 10 meter	± 1mm per meter	± 1mm per meter	± 2mm per meter
<b>Features</b>	<ul style="list-style-type: none"> <li>Auto Rotating beam</li> <li>Portable, suitable for construction sites. Power: 6VDC</li> </ul>	<ul style="list-style-type: none"> <li>Professional tripod</li> <li>c/w carry case</li> <li>Power: 3VDC</li> </ul>	<ul style="list-style-type: none"> <li>Analogue angle finder</li> <li>Includes carry bag</li> </ul>	<ul style="list-style-type: none"> <li>Lightweight magnetic base</li> <li>Vertical and horizontal</li> </ul>





## SPIRIT LEVELS

Torpedo Level	Spirit Levels - 3 Vial			Post Level
				
<b>LD-S93B</b> Length - 225mm	<b>LD-2007-2B-600</b> Length - 600mm	<b>LD-2007-2B-1000</b> Length - 1000mm	<b>LD-2007-2B-1200</b> Length - 1200mm	<b>F7708LS6</b> Size: 125 x 75mm

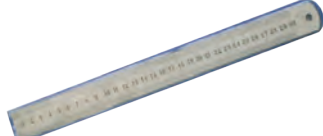
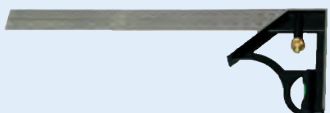



## MEASURING EQUIPMENT

Standard Measuring Tapes		Digital Measuring Tape		Fibre Glass Measuring Tapes			
						- with spike for accuracy 	
<b>LD-10NO7X</b> 10 meter Auto-rolling steel tape	<b>TM-3M</b> 3 meter Auto-rolling steel tape	<b>TM-5M</b> 5 meter Auto-rolling steel tape	<b>LD-SX501E</b> Digital display - 5 meter Memory and backlight Dual system measurement (metric/imperial)	<b>TM-20M</b> 20 meter Manual rolling	<b>TM-50M</b> 50 meter Manual rolling	<b>JC-306</b> 30 meter Manual rolling	<b>JC-506</b> 50 meter Manual rolling

Try & Mitre Square		General Purpose T Square		Stainless Steel Rulers		Combination Square 300mm	
							
<b>F7501KH441</b> 150mm	<b>F7502KH442</b> 200mm	<b>F4569GPTS6</b> 600mm	<b>F4570GPTS10</b> 1000mm	<b>ARK-167103-12</b> 12" / 300mm	<b>ARK-167103-20</b> 20" / 500mm	<b>SB205562</b> Adjustable Square with spirit level	

Digital Vernier		Digital Outside Micrometer		O-Ring & Scriber Set		Dividers		Chalk Line	
									
<b>SB168101-8</b> 0 - 200mm - Large Display		<b>SB168163-1</b> 0 - 25mm		<b>SS-4-KIT</b> Scriber, Hook and Picker		<b>YG-100</b> 100mm Dividers		<b>SB256713</b> 30m / 100"	<b>SB0765010</b> Blue Colour Chalk Powder

## MAGNIFYING GLASSES

				
<b>Code</b>	<b>ZD-10D</b>	<b>TLE-1099</b>	<b>TLE-1094</b>	<b>TLE-1104</b>
	<ul style="list-style-type: none"> <li>Magnifying Glass with holding spring clips (x2)</li> <li>Can be locked at a specific angle</li> </ul>	<ul style="list-style-type: none"> <li>Ø: 90mm</li> <li>With illumination</li> <li>Works on 2x1.5V AA batteries (not included)</li> </ul>	<ul style="list-style-type: none"> <li>Power: 230VAC, 22W (T5)</li> <li>Size of lens: 5"</li> <li>Diopter/power: 5 Diopter</li> <li>Colour: White</li> </ul>	<ul style="list-style-type: none"> <li>Head Magnifying Glass</li> <li>Power: 1.8X, 2.3X, 3.7X, 4.8X</li> </ul>



## TOOL KITS 1000V

	1000V 10 Pc Electrician Tool Set + Carry Bag (VDE)	1000V 12 Pc Electrician Tool Set + Carry Bag (VDE)			1000V 31 Pc Electricians Back Pack (VDE)
			Multimeter not included		
<b>Code</b>	<b>V10-010</b>	<b>V10-012</b>			<b>BT-032</b>
Description	<ul style="list-style-type: none"> <li>• 5Pcs Electricians Screwdriver VDE 1000V:                             <ul style="list-style-type: none"> <li>- PH0 x 60, PH1 x 80, PH2 x 100</li> <li>- Slotted 4 x 100mm, 6.5 x 150mm</li> </ul> </li> <li>• 1Pc Long Nose Plier 150mm VDE 1000V</li> <li>• 1Pc Side Cutter 150mm VDE 1000V</li> <li>• 1Pc Wire Stripper 150mm VDE 1000V</li> <li>• 1 Roll Insulation Tape 10m</li> <li>• 1Pc Voltage Tester / Screw Driver 140mm</li> </ul>	<ul style="list-style-type: none"> <li>• 5Pcs Electricians Screwdriver VDE 1000V:                             <ul style="list-style-type: none"> <li>- PH0 x 60, PH1 x 80, PH2 x 100</li> <li>- Slotted 4 x 100mm, 5.5 x 125mm</li> </ul> </li> <li>• 1Pc Long Nose Plier 150mm VDE 1000V</li> <li>• 1Pc Side Cutter 150mm VDE 1000V</li> <li>• 1Pc Wire Stripper 150mm VDE 1000V</li> <li>• 1Pc Stripping Tool 200mm</li> <li>• 1Pc 7 LED Head light</li> <li>• 1 Roll Insulation Tape 10m</li> <li>• 1Pc Voltage Tester / Screw Driver</li> <li>• Carry Bag 400 x 230 x 285mm</li> </ul>			<ul style="list-style-type: none"> <li>• 150mm Cable Cutter VDE 1000V</li> <li>• 160mm Wire Stripper VDE 1000V</li> <li>• 160mm Long Nose Pliers VDE 1000V</li> <li>• 200mm Combination Plier VDE 1000V</li> <li>• 180mm HD Side Cutter VDE 1000V</li> <li>• 7Pc Screwdriver Set VDE 1000V</li> <li>• 250mm Groove Joint Plier VDE 1000V</li> <li>• 7Pcs Allen Key Set</li> <li>• 300mm Groove Joint Plier</li> <li>• 220mm HD un-insulated crimper</li> <li>• Headlight 7 x White LED 3/stage</li> <li>• SW8 Socket Wrench Screwdriver</li> <li>• 200mm Insulated Shifting Spanner</li> <li>• WAK2 Utility Knife • 5Mtr Measuring Tape</li> <li>• 250mm Vice Grips • 150mm Mini Hacksaw</li> <li>• 300mm BP Ball peen Hammer</li> </ul>
	<b>Belt Pouch</b>	<b>Equipped Imitation Leather Case</b>			<b>13pc Screwdriver Set</b>
<i>intercable</i>					
<b>Code</b>	<b>19142 (Kit)</b>	<b>19140 (Empty Case)</b>	<b>19231 (Kit)</b>	<b>19230 (Empty Case)</b>	<b>SB0607243</b>
Size	200 x 100 x 200mm		360 x 290 x 75mm		
Equipped with	Screwdriver for slotted head screws Futur II 0.5 x 3 x 100mm (1301030) Futur II 0.8 x 4 x 100mm (1301040) Futur II 1.2 x 6.5 x 150mm (1301065) Screwdriver for Philips screws "Philips" Futur II PH 1 x 75 (13021) "Philips" Futur II PH 2 x 100 (13022) Engineers pliers 190mm (AP0119N) Cable cutter 160mm (AP1017) Special electricians scissors (16011) Voltage tester (AV6104) Power disc cable puller (AV8902)		Engineers pliers 190mm (AP0119N) Long Nose pliers c/w straight jaws (AP0416N) Screwdriver for slotted head screws Futur II 0.5 x 3 x 100mm (1301030) Futur II 0.8 x 4 x 100mm (1301040) Futur II 1.2 x 6.5 x 150mm (1301065) Screwdriver for Philips screws "Philips" Futur II PH 1 x 75 (13021) "Philips" Futur II PH 2 x 100 (13022) "Pozidriv" Futur II PZ 1 x 75 (13031) "Pozidriv" Futur II Pz 2 x 100 (13032) Cable knife (AV3920) Insulated scissors (AV6720) Cable cutter 160mm (AP1017)		• 4 Piece Slotted Screwdrivers: <ul style="list-style-type: none"> <li>- 1.2 x 6.5 x 100mm</li> <li>- 1 x 5.5 x 100mm</li> <li>- 0.8 x 4 x 100mm</li> <li>- 0.5 x 3 x 100mm</li> </ul> • 2 x Phillips Screwdrivers: <ul style="list-style-type: none"> <li>- PH2 x 100mm</li> <li>- PH1 x 80mm</li> </ul> • 2 x Pozidrive Screwdrivers: <ul style="list-style-type: none"> <li>- PZ2 x 100mm</li> <li>- PZ1 x 80mm</li> </ul> • 1 x Single Pole Voltage Tester • 1 x Clip-on Screwdriver handle



## TOOLS



**Soft Back-Pack/Trolley - 14pcs**

<b>Code</b>	<b>BM1815</b> without Tools
<b>Code</b>	<b>BM1815A1</b> with Tools

- **Screwdrivers:**
  - 1) Flat VDE Insul. 3 x 100mm
  - 2) Flat VDE Insul. 4 x 100mm
  - 3) Flat VDE Insul. 5,5 x 125mm
  - 4) Flat VDE Insul. 6,5 x 150mm
  - 5) Phillips VDE Insul. PH0 x 60mm
  - 6) Phillips VDE Insul. PH1 x 80mm
  - 7) Phillips VDE Insul. PH2 x 100mm
- Voltage Tester Flat 3 x 60mm 250V
- Combination Plier VDE Insul. 180mm
- Engineers Hammer
- Pocket Saw
- Cutter Stripper Scissor + Box
- Measuring Tape 3m x 16mm
- Pocket Spirit Level 220mm

**Belt Bag - 5pcs**





**ALL INCLUDED**

Kit Code: **BM18030M1**  
Bag Code: **BM18030**

<b>Code</b>	<b>BM18030M1</b>
<b>Code</b>	<b>BM18030</b> (pouch only)

- **Screwdrivers:**
  - 1) FLAT 3 x 100mm
  - 2) FLAT 4 x 100mm
  - 3) PHILLIPS PH1 x 80mm
- Combination Pliers 180mm
- Stainless Steel Shears (**BM1310**)

**Tool Back-Pack - 11pcs**



**ALL INCLUDED**

<b>Code</b>	<b>BM18122</b>
-------------	----------------

- **Screwdrivers:**
  - 1) FLAT 3 x 100mm
  - 2) FLAT 4 x 100mm
  - 3) FLAT 5.5 x 125mm
  - 4) PHILLIPS PH1 x 80mm
  - 5) POZI PZ1 x 80mm
- Combination Pliers 160mm
- Stainless Steel Shears (**BM1310**)
- Side Cutter 140mm
- Voltage Tester
- Measuring Tape 3m
- Universal Knife



**ALL INCLUDED**

**Tool Case with Wheels 72pcs**

<b>Code</b>	<b>BM18403</b> (Kit)	
<b>Code</b>	<b>BM18400</b> (Case Only)	

• VDE insulated bi-component tools	• Long Nose Plier: 200mm	• Measuring Tape: 3m
• Screwdrivers: 2 x 75	• Flat Nose Plier: 160mm	• Rewinding Cord Marker (Chalk line)
4 x 100	• Water Pump Plier: 250mm	• Blue Chalk: 250g
5.5 x 125	• Crimping Tool: isol 0.25 - 6mm <sup>2</sup>	• Aluminium Spirit Level: 220mm
6.5 x 150	• Retaining Screwdriver: 4 x 125/PH1x 150	• Adjustable Wrench
8 x 175	• Voltage Tester: 220V-250 V, 3.5 x 100	• Allen Wrench Set: 9pcs
PH0 x 60	• Stainless Steel Scissors	• Panel Key
PH1 x 80	• Cable Shear: 35mm <sup>2</sup>	• Double Ended wrench Set: 8pcs
PZ2 x 100	• Pocket Saw	• Hammer: 300g
PZ3 x 150	• Cable Stripping Knife: 8 - 28mm	• Chisel: 250g
• Nut Drivers: 10-13	• Universal Knife	• Puncher Chisel: 250mm
• Combination Plier: 160mm	• Automatic Stripping Tool: 0.5 - 4mm <sup>2</sup>	• HSS and Masonary Drill Set 19pcs
• Side Cutter: 160mm		



**NEW**

**ALL INCLUDED**

**Tool Case with Wheels 167pcs**

<b>Code</b>	<b>TK-3167</b>	
-------------	----------------	--

VDE Screwdrivers:	• 6 x Precision Screwdrivers	• 1 x Machinist's Hammer 300g
• 6 x 38	• 1 x 1/4" Bit Adaptor	• 1 x Combination Plier 180mm
• 6 x 100	• 1 x Tester 200-250V, CE	• 1 x Half Round Steel File 200mm
• 5 x 100	• 1 x Screwdriver Bit Holder	• 1 x 1/4" Dr. Extension Bar 75mm
• PH2 x 100	• 1 x Long Nose Plier 150mm	• 2 x 1/2" Dr. Extension Bars 125 & 250mm
• PH2 x 38	• 1 x Screwdriver Handle 1/4"	• 2 x 1/2" Spark Plug Sockets 16 & 21mm
• PH1 x 75	• 1 x Caliper 150mm	• 7 x Spanners: 8-10-12-13-14-17-19mm
• PH2 x 100mm	• 1 x Hack Saw 300mm	• 32 x Bit Set with Quick Chuck Bit Holder
• Combination Plier: 180mm	• 1 x 1/4" Dr. Sliding Bar	• 9 x Hex Keys: 1.5-2-2.5-3-4-5-6-8-10mm
• 3 x Saw Blades	• 3 x Carpenter's Pencils	• 9 x Torx Set: T10-15-20-25-27-30-40-45-50
• 1 x Knife 18mm	• 1 x Try Square 250mm	• 1 x 1/2" Dr. 72 Teeth Quick Release Ratchet Handle
• 1 x Level 400mm	• 1 x 1/2" Universal Joint	• 1 x 1/4" Dr. 72 Teeth Quick Release Ratchet Handle
• 1 x Crimping Tool	• 1 x Measuring Tape 3m	• 12 x 1/4" Dr. Sockets: 4-4.5-5-5.5-6-7-8-9-10-11-12-13mm
• 10 x Blades 18mm	• 30 x Terminals in Plastic Box	• 12 x 1/2" Dr. Sockets: 10-11-12-13-14-15-17-18-19-20-22-24
• 1 x 3-Way Adaptor	• 1 x Water Pump Plier 250mm	• 1 x Adjustable Wrench - MAX working open distance 29mm

## TOOL KITS

Tool Kit with spot-light and red/amber blinking light c/w car plug. Uses 4 x size 'C' batteries (not included)



<b>Code</b>	<b>PL-8985</b>	<b>SB210120</b>	<b>SB210123</b>
	13 Pieces	39 Pieces	48 Pieces
			<b>Telecoms Tool Kit</b>
<b>Code</b>	<b>SB210112</b>	<b>SB003017</b>	<b>ZD-922B</b>
	63 Pieces	10 Pieces	<p>Kit Includes:</p> <ul style="list-style-type: none"> <li>• RJ11/45 Crimping Tool</li> <li>• RJ11, 12, 45 connectors</li> <li>• Network cable tester</li> <li>• Cable stripper</li> <li>• Impact insertion tool</li> </ul>

## ELECTRONIC TOOL KITS

Nylon Tool Bag



<b>Code</b>	<b>ZD-963</b>	<b>ZD-902</b>	<b>ZD-906</b>	<b>ZD-907</b>
-------------	---------------	---------------	---------------	---------------

## MECHANICAL TOOLBOX

85 Piece Kit in 5 Tray Cantilever Box



Code	TOOT2631
	<ul style="list-style-type: none"> <li>• 1 x 1/2" Sliding T Bar</li> <li>• 18 pc 1/2" Sockets : 8, 10, 11, 12, 13, 14, 15, 16, 17, 18, 19, 20, 21, 22, 24, 27, 30, 32mm</li> <li>• 1pc Universal Joint 1/2"</li> <li>• 1pc Extension bar 125mm</li> <li>• 1pc 1/2" H handle</li> <li>• 1pc Ratchet 1/2"</li> <li>• 7 Pc Combination Screwdriver: Slotted: 3.2*75mm, 4*100mm, 6x100mm, 8x150mm Phillips: PH1*75mm, PH2*100mm, PH3*150mm</li> <li>• 12 Pc Combination Spanner: 8,10,11,12,13,14,15,16, 17,18,19,22mm</li> <li>• 1 x 10" Water Pump Pliers</li> <li>• 1 x 10" Vice Grip</li> <li>• 1 x Tape Measure 5m x 19mm</li> <li>• 1 x Combination Plier 180mm</li> <li>• 1 x Side Cutter 160mm</li> <li>• 1 x Long Nose Plier 160mm</li> <li>• 2 x Spark Plug Sockets:16,21mm</li> <li>• 1 x Trimming Knife + 5 Pc Blades</li> <li>• 1 x 9Pc Allen Key Set : 1.5, 2, 2.5, 3, 4, 5, 6, 8, 10mm</li> <li>• 1 x 9Pc Torx Key Set: T10, 15, 20, 25, 27, 30, 40, 45, 50</li> <li>• 10pc BITS: SL3, SL4, SL5, PZ1, PZ2, PH1, PH2, PH3, T10, T15 + Handle</li> </ul>



## 1000V TOOL KITS

### Wera Zyklop VDE Ratchet Set with 3/8" drive

Individually tested as per IEC60900 at 10,000V for safe working at the approved voltage of 1.000V

- Slim design to enable work in confined spaces.
- Fine tooth mechanism with 80 teeth for a return angle of only 45°.
- The ball lock ensures sockets and accessories are securely fitted, providing increased safety during operation.
- A short press on the release button allows the tool to be changed quickly.



### Individual VDE Insulated Sockets

Code	Description
5004950001	6mm x 46mm 3/8" Socket
5004951001	7mm x 46mm 3/8" Socket
5004952001	8mm x 46mm 3/8" Socket
5004953001	9mm x 46mm 3/8" Socket
5004954001	10mm x 46mm 3/8" Socket
5004955001	11mm x 46mm 3/8" Socket
5004956001	12mm x 46mm 3/8" Socket
5004957001	13mm x 46mm 3/8" Socket
5004958001	14mm x 46mm 3/8" Socket
5004959001	15mm x 46mm 3/8" Socket
5004960001	16mm x 46mm 3/8" Socket
5004961001	17mm x 46mm 3/8" Socket
5004962001	18mm x 46mm 3/8" Socket
5004963001	19mm x 46mm 3/8" Socket



### VDE Socket Set c/w Ratchet

Code	5004970001
Description	17Pcs VDE Insulated Ratchet Set - 3/8"
	- 1 x Ratchet
	- 1 x Short Extension
	- 1 x Long Extension
	- Sockets: 6, 7, 8, 9, 10, 11, 12, 13, 14, 15, 16, 17, 18, 19



### Insulated Reversible Ratchet

Code	5004966001
Description	3/8" x 222mm Ratchet



### Insulated Long Extension

Code	5004965001
Description	3/8" x 166mm









### Insulated Short Extension



Code	5004964001
Description	3/8" x 91mm



**HAND TOOLS**

<p><b>Tool - Check Plus</b></p>  <p>813 Handle 1/4" Adapter 889/4/1 K Universal Bit Holder 8001A Mini Ratchet</p>	<p><b>BlackLaser Multicolour L-Key Set Metric</b></p> 	<p><b>Kraftform Kompakt VDE 60i</b></p>  <p>VDE TOOL KRAFTFORM ERGONOMIK ANTI ROLL-OFF EXTRA SLIM</p>
<p><b>W-TC-PLUS/37</b></p> <ul style="list-style-type: none"> <li>8790 HMA Sockets 1 x 5.5, 1 x 6.0, 1 x 7.0, 1 x 8.0, 1 x 10.0, 1 x 12.0, 1 x 13.0</li> <li>851/1 TZ PH : 2 x PH1, 3 x PH2, 1 x PH3</li> <li>855/1 TZ PZ : 1 x PZ1, 3 x PZ2, 1 x PZ3</li> <li>867/1 TZ Torx: 1 x Tx10, 1 x Tx15, 1 x Tx20, 1 x Tx25, 1 x Tx30, 1 x Tx40</li> <li>867/1 TZ Torx BO: 1 x Tx10, 1 x Tx15, 1 x Tx20, 1 x T25, 1 x Tx30</li> <li>840/1 Z HexPlus: 1 x 3.0, 1 x 4.0, 1 x 5.0, 1 x 6.0, 1 x 8.0</li> <li>800/1 TZ Slotted: 1 x 1.0 x 5.5</li> </ul>	<p><b>W-950SPKL/9</b></p> <p>Colour coded sleeves for easy recognition, HEX-Plus, Ball-end Hexagon on Long arm.</p> <ul style="list-style-type: none"> <li>1 x 1.5 x 90</li> <li>1 x 2.0 x 101</li> <li>1 x 2.5 x 112</li> <li>1 x 3.0 x 123</li> <li>1 x 4.0 x 137</li> <li>1 x 5.0 x 154</li> <li>1 x 6.0 x 172</li> <li>1 x 8.0 x 195</li> <li>1 x 10.0 x 224</li> </ul>	<p><b>W-KK-VDE/16</b></p> <p>16pc set in Folding Textile Pouch Interchangeable Blades 154mm long</p> <ul style="list-style-type: none"> <li>1 x PH1, 1 x PH2</li> <li>1 x PZ1, 1 x PZ2</li> <li>1 x PZ/S1, PZ/S2</li> <li>1 x TX10, 1 x TX15, 1 x TX20, 1 x TX25</li> <li>1 x 0.4 x 2.5, 1 x 0.6 x 3.5, 1 x 0.8 x 4.0, 1 x 1.0 x 5.5</li> <li>1 x 0.5 x 3.0 x 70 Voltage Tester</li> </ul>

<p><b>Kraftform 6Pcs Set</b></p> 	<p><b>Kraftform Classic 6Pcs Set</b></p> 	<p><b>Kraftform 8Pcs Set</b></p>  <p><b>NEW</b></p>	<p><b>Kraftform Classic 8Pcs Set</b></p>  <p><b>NEW</b></p>
<p><b>W-10001/6</b></p> <ul style="list-style-type: none"> <li>0.60 x 3.5 x 75</li> <li>0.80 x 4.0 x 100</li> <li>1.20 x 6.5 x 125</li> <li>1.20 x 8.0 x 150</li> <li>PH No.1 x 80</li> <li>PH No.2 x 100</li> </ul>	<p><b>W-1734/6</b></p> <ul style="list-style-type: none"> <li>0.60 x 3.5 x 75</li> <li>0.80 x 4.0 x 100</li> <li>1.20 x 6.5 x 125</li> <li>1.20 x 8.0 x 150</li> <li>PH No.1 x 80</li> <li>PH No.2 x 100</li> </ul>	<p><b>W-10008/8</b></p> <ul style="list-style-type: none"> <li>2.5 x 75</li> <li>3.0 x 80</li> <li>4.0 x 100</li> <li>5.5 x 125</li> <li>6.5 x 150</li> <li>8.0 x 175</li> <li>PH No.1 x 80</li> <li>PH No.2 x 100</li> </ul>	<p><b>W-1734/8</b></p> <ul style="list-style-type: none"> <li>2.5 x 75</li> <li>3 x 80</li> <li>4 x 100</li> <li>5.5 x 125</li> <li>6.5 x 150</li> <li>8 x 175</li> <li>PH No.1 x 80</li> <li>PH No.2 x 100</li> </ul>

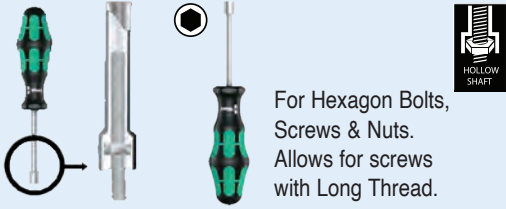
<p><b>Kraftform 11Pcs Set</b></p>  <p>For TORX Screws</p>	<p><b>VDE Kraftform Comfort 6Pcs Set</b></p> <p><b>NEW</b></p> 	<p><b>Kraftform Plus 395 Hollow Shaft Nutdriver</b></p>  <p>For Hexagon Bolts, Screws &amp; Nuts. Allows for screws with Long Thread.</p> <p><b>HOLLOW SHAFT</b></p>																																
<p><b>W-6334/11</b></p> <ul style="list-style-type: none"> <li>T6</li> <li>T7</li> <li>T8</li> <li>T9</li> <li>T10</li> <li>T15</li> </ul>	<ul style="list-style-type: none"> <li>T20</li> <li>T25</li> <li>T27</li> <li>T30</li> <li>T40</li> </ul>	<p><b>W-10621/6</b></p> <ul style="list-style-type: none"> <li>0.4 x 2.50 x 80</li> <li>0.60 x 3.5 x 100</li> <li>0.80 x 4.0 x 100</li> <li>1.00 x 5.5 x 125</li> <li>1.20 x 6.5 x 150</li> <li>1.60 x 8.00 x 200</li> </ul>	<ul style="list-style-type: none"> <li>PH No.1 x 80</li> <li>PH No.2 x 100</li> </ul>	<table border="1"> <thead> <tr> <th>Code</th> <th>⌀</th> <th>→</th> <th>→</th> <th>Nut/Screw Size</th> </tr> </thead> <tbody> <tr> <td>W-395-HO-5.5</td> <td>5.5mm</td> <td>70mm</td> <td>98mm</td> <td>M3</td> </tr> <tr> <td>W-395-HO-7</td> <td>7mm</td> <td>80mm</td> <td>105mm</td> <td>M4</td> </tr> <tr> <td>W-395-HO-8</td> <td>8mm</td> <td>80mm</td> <td>105mm</td> <td>M5</td> </tr> <tr> <td>W-395-HO-10</td> <td>10mm</td> <td>80mm</td> <td>105mm</td> <td>M6</td> </tr> <tr> <td>W-395-HO-13</td> <td>13mm</td> <td>90mm</td> <td>112mm</td> <td>M8</td> </tr> </tbody> </table>	Code	⌀	→	→	Nut/Screw Size	W-395-HO-5.5	5.5mm	70mm	98mm	M3	W-395-HO-7	7mm	80mm	105mm	M4	W-395-HO-8	8mm	80mm	105mm	M5	W-395-HO-10	10mm	80mm	105mm	M6	W-395-HO-13	13mm	90mm	112mm	M8
Code	⌀	→	→	Nut/Screw Size																														
W-395-HO-5.5	5.5mm	70mm	98mm	M3																														
W-395-HO-7	7mm	80mm	105mm	M4																														
W-395-HO-8	8mm	80mm	105mm	M5																														
W-395-HO-10	10mm	80mm	105mm	M6																														
W-395-HO-13	13mm	90mm	112mm	M8																														





1000V

HRC 51-54 Hardened & Tempered

CrV 6150 Chrome Vanadium

Magnetic Tip



## HAND TOOLS 1000V



### Slotted Electrical Screwdrivers 1000V (VDE)

Code	mm	mm	mm	Code	mm	mm	mm
VJF-258-1	2.5	80	160	VJF-258-5	6.5	150	258
VJF-258-2	3.5	75	155	VJF-258-6	3.0	100	197
VJF-258-3	4.0	100	197	VJF-258-7	8.0	150	267
VJF-258-4	5.5	125	233	VJF-258-8	8.0	200	317

### Philips Electrical Screwdrivers 1000V (VDE)

Code	size	mm	mm	Code	size	mm	mm
VJF-258-9	0	75	155	VJF-258-12	2	100	197
VJF-258-10	1	80	177	VJF-258-13	3	150	258
VJF-258-11	1	100	197				

### Pozidrive Electrical Screwdrivers 1000V (VDE)

Code	size	mm	mm	Code	size	mm	mm
VJF-258-14	0	75	155	VJF-258-17	2	100	197
VJF-258-15	1	80	177	VJF-258-18	3	150	258
VJF-258-16	1	100	197				



### Insulated Screwdriver Sets 1000V (VDE)

#### 12 Piece VDE Tool Set

Code	mm	mm	mm	size	mm	mm
V10-4005	3.5	75	155	0	75	155
	4.0	100	197	1	80	177
	5.5	125	233	2	100	197

#### Kit Includes

- VDE Wire Stripper
- VDE Long Nose pliers
- VDE diagonal Cutter
- VDE Combination Pliers (150mm each)

Screwdriver - Includes Testing Function 100-250VAC. c/w 2 x Testers, 100-250VAC

#### 6 Piece Kit

Code	mm	size	mm	mm
VFL-2105	2.5		75	140
	3.5		75	160
	4		100	200
	5.5		125	236
		1	80	180
	2	100	200	

#### 8 Piece Kit

Code	mm	size	mm	mm
VFL-2234	3.5		75	160
	4		100	200
	5.5		125	236
	6.5		150	258
		0	75	160
		1	80	180
	2	100	200	

Screwdriver - Includes Testing Function 100-250VAC c/w 1 x Tester, 100-250VAC, 140mm

Screwdriver - Includes Testing Function 100-250VAC c/w 1 x Tester, 100-250VAC, 140mm



VFL-2105





VFL-2234

	Combination Pliers	Long Nose Pliers	Bent Nose Pliers	Side Cutters	
<ul style="list-style-type: none"> <li>• 1000V VDE</li> <li>• Chrome Vanadium Steel</li> <li>• Micro Finish</li> <li>• Bi-material TPR Handle</li> </ul>					
Code (150mm) 6"	V10-2105	V10-2108	V10-2113	V10-2110	
Code (180mm) 7"	V10-2106	-	-	V10-2115	
Code (200mm) 8"	V10-2107	V10-2109	V10-2114	-	
	Wire Stripper	Roundnose Pliers	Flatnose Pliers	Waterpump Pliers	Insulated Linesman Pliers
Code (150mm) 6"	V10-2112	V10-2118	V10-2117	-	1000V - with integrated crimper
Code (250mm) 9"	-	-	-	V10-2116	10-2207 (250mm)

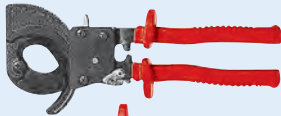
## 1000V INSULATED TOOLS

	1607054	<b>Cable Cutter with Ratchet</b> <ul style="list-style-type: none"> <li>• For copper and aluminium cables only</li> <li>• Special blades with high cutting capacity</li> <li>• With opening device</li> </ul>	Cable Size		Code	Length mm
	1602200		Ømm	mm <sup>2</sup>		
			52	380	1607054	380
			22	80	1602200	200

	<b>Universal-knife with Interchangeable Blade</b>			
	<ul style="list-style-type: none"> <li>• With ordinary blade</li> <li>• made of shock-proof material</li> </ul>		AV3910	200
	Spare blade for AV3910		AV3911	-

	<b>Cable-knife with Blade Protection (For Cable Stripping)</b>			
	<ul style="list-style-type: none"> <li>• With solid blade and insulated blade-back</li> <li>• Special blade cuts insulation, not copper</li> <li>• made of shock-proof material</li> </ul>		AV3920	200
	Spare blade for AV3920		AV3921	-

	<b>Scissors</b>			
	<ul style="list-style-type: none"> <li>• Surface treatment: Burnished Protected</li> <li>• Handles of shock-proof plastic</li> </ul>		AV6720	180

	<b>Set - Cable-stripping Tool (AMS)</b>			
	Kit Includes: 1 Cable-stripping-tool (AV6220) 1 Cable knife (AV3920) 1 Spare blade (AV3921)		AS1003	240 x 260 height

	<b>Retaining Screwdrivers for Slotted Head Screws</b>					
	Description	Code	⌀	mm	mm	mm
	<ul style="list-style-type: none"> <li>• Blade of tempered, high-alloyed steel (surface: browned)</li> </ul>	AC1451	3.0	100	0.5	190
		AC1452	4.0	125	0.7	225
		AC1453	5.0	150	0.8	285

	<b>Retaining Screwdrivers for Phillips Screws</b>				
	Description	Code	⊕	mm	mm
	<ul style="list-style-type: none"> <li>• Blade of tempered, high-alloyed steel (surface: browned)</li> </ul>	AC1750	0	125	225
		AC1751	1	150	260
		AC1752	2	175	285

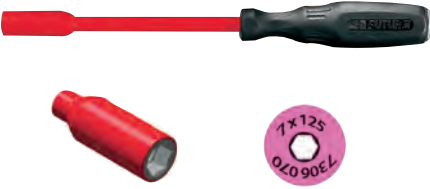
	<b>Screwdrivers for Hexagon Screws</b>					
	Description	Code	⬡	mm	mm	
	<ul style="list-style-type: none"> <li>• Blade of tempered, high-alloyed steel (surface: browned)</li> <li>• With power handle</li> </ul>	1306040	4	125	215	
		1306050	5	125	215	
		1306060	6	125	215	
		1306080	8	125	225	
		1306100	10	125	225	
		1306130	13	125	225	
		UNI 6750				
		DIN 7445				

	<b>Single Ended Spanner</b>				
	<ul style="list-style-type: none"> <li>• Quality symbol VDE/GS only for sizes 10-24mm</li> <li>• Spanner inclination: 15°</li> <li>• Tempered, alloyed steel</li> </ul>				
		AC2006	6	-	105
		AC2008	8	-	105
		AC2010	10	-	105
	AC2013	13	-	132	





## FIXED BLADE CABLE KNIVES

	Code	Description
	31HS	• Fixed Straight Blade Wire Stripper
	32HS	• Fixed Hook Blade - No damage on conductor cores
	33HS	• Fixed Hook Blade - Suitable for sector cables

## HAND TOOLS



### Hammers & Mallets



Claw Hammer	Ball Hammer	Rubber Mallet
		
566gram <b>SB203016</b>	440gram <b>SB203162-16</b> 672gram <b>SB203162-24</b>	440gram <b>SB203541-16</b> 672gram <b>SB203541-24</b>
Fully polished with plastic coated handle	Fully polished with plastic handle	With fibreglass handle



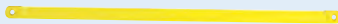

Two Way Mallet	Stone Hammer	Cold Chisels	
			
35mm Ø <b>SB203591-35</b> 45mm Ø <b>SB203591-45</b>	1kg <b>ARK-146301-1</b> 2kg <b>ARK-146301-2</b>	<b>B15013</b> 13 x 150mm	<b>B25025</b> 25 x 150mm
With fibreglass handle	Drop forged	19 x 200mm, with Hand Protector	

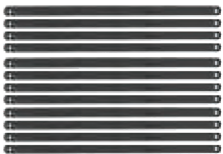
Wrecking Bar	Tommy Bar	Center Punch	Punch Sets
			
<b>B450WB</b> 450 x 19mm	<b>B600WB</b> 600 x 19mm	<b>B450TB</b> 450 x 19mm	<b>B600TB</b> 600 x 19mm
		<b>3210030K</b> 3 x 120mm	<b>3210050K</b> 5 x 120mm
		<b>YT-6855</b> 9pcs, Numbers	
		<b>YT-6863</b> 27pcs, Letters	

### Tubular Hacksaws

3Pc File Set	Oval Tubular Hacksaw Frame	Square Tubular Hacksaw Frame	Spare Hacksaw Blades
			
<b>SB208863</b> 200mm (8") flat, round, half round	<b>SB208101</b> With aluminium handle 250-300mm	<b>SB208172</b> With aluminium handle and soft grip 300mm (12")	<b>SB208311</b> 12 Pieces 300mm (12")

Junior Hacksaw	Spare Junior Hacksaw Blades	Cable Tie Tensioners	
			
<b>ARK-243111-6</b> All Aluminium 6"	<b>TOOH860</b> 12 Pieces 6" Blades	<b>HS-600A</b> Cable Tie Gun for tensioning and auto cutting for ties 2.5-4.8mm	<b>TG-100</b> Cable Tie Gun for tensioning and manual cutting for ties 2.5-4.8mm

Suction Lifters			Plastic Tape Dispenser	Silicon/Caulking Gun
				
<b>BM1770</b>	<b>BM1760</b>	<b>BM1761</b>	<b>HL5041</b> For use with packaging tape	<b>SB257803</b> Rubber grip to prevent slipping
Cup Size: 120mm Ø				

## UTILITY KNIVES & SETS

Heavy Duty Blades	Folding Knife	Utility Knife	3pc Utility Knife Set	Snap-off Knife	Snap-off Blades
<b>F4030TK1B/H5</b> (5Pcs) <b>F4036TK1B/H20</b> (20Pcs) <b>F4031TK1B/H100</b> (100Pcs) Made in Sheffield England	<b>F4004TK7</b> With Belt Clip & Blade Included	<b>SB215009</b> Zinc Alloy, 3 Blades in Handle, Retractable <b>SB215152</b> (10Pc) Spare Blades	<b>SB215162</b> Large Snap-off Knife, Small Snap-off Knife, Heavy Duty Utility Knife	<b>F4001TK5</b> (18mm) <b>SB215120</b> (9mm) Adjustable Utility Knife with Snap off Blades	<b>F7748TK6B</b> (18mm) <b>SB215153</b> (9mm) Spare Blades

## HAND TOOLS

	Shifting Spanners	Water Pump (Gas) Pliers	Vice Grip (Curved Jaw)
<b>Code</b> (125mm) 5"	-	-	<b>HT10-4026</b>
<b>Code</b> (180mm) 7"	-	-	<b>HT10-4027</b>
<b>Code</b> (200mm) 8"	<b>HT12-1062</b>	<b>HT10-5531</b>	-
<b>Code</b> (254mm) 10"	<b>HT12-1063</b>	<b>HT10-5532</b>	<b>HT10-4028</b>
<b>Code</b> (300mm) 12"	<b>HT12-1064</b>	<b>HT10-5534</b>	-

Mini Pliers • Bi-Material TPR Handle (soft rubber)

	Electronic Side Cutter	Long Nose	Bent Nose	Flat Nose	Round Nose
<b>Code</b>	<b>HT10-3069</b>	<b>HT10-3061</b>	<b>HT10-3062</b>	<b>HT10-3063</b>	<b>HT10-3064</b>
<b>Desc.</b>	130mm	128mm	128mm	115mm	101mm
	Diagonal Cut	End Cut	Linesman	Needle Nose	
<b>Code</b>	<b>HT10-3065</b>	<b>HT10-3066</b>	<b>HT10-3067</b>	<b>HT10-3068</b>	
<b>Desc.</b>	101mm	101mm	115mm	153mm	



# HAND TOOLS

Spanners • Material: Chrome Vanadium Steel

Combination Spanner				Double Open Ended Spanner			
Size mm	Code	Size mm	Code	Size mm	Code	Size mm	Code
6	HT12-4206	19	HT12-4219	6 – 7	HT12-6206	20 – 22	HT12-6220
7	HT12-4207	20	HT12-4220	8 – 9	HT12-6208	21 – 23	HT12-6221
8	HT12-4208	21	HT12-4221	10 – 11	HT12-6210	22 – 24	HT12-6222
9	HT12-4209	22	HT12-4222	12 – 13	HT12-6212	25 – 28	HT12-6225
10	HT12-4210	23	HT12-4223	14 – 15	HT12-6214	27 – 29	HT12-6227
11	HT12-4211	24	HT12-4224	16 – 17	HT12-6216	30 – 32	HT12-6230
12	HT12-4212	25	HT12-4225	18 – 19	HT12-6218		
13	HT12-4213	26	HT12-4226	<b>Pipe Wrench 9"</b>		<b>Screwdriver Bit</b>	
14	HT12-4214	27	HT12-4227	<b>Code</b>	<b>SB137803-9</b>	<b>HSB-PH2/5MM</b>	
15	HT12-4215	28	HT12-4228				
16	HT12-4216	29	HT12-4229			1/4"x PH2x50mm	
17	HT12-4217	30	HT12-4230				
18	HT12-4218	32	HT12-4232				

## Spanner & Allen (Hex) Key Sets

8pc Aluminium Frame Folding Tool		30Pc		9Pc	Ball Point
<ul style="list-style-type: none"> <li>Metric Type</li> <li>1.5, 2, 2.5, 3, 4, 5, 6, 8</li> </ul>	<ul style="list-style-type: none"> <li>Torx</li> <li>T9, T10, T15, T20, T25, T27, T30, T40</li> </ul>	0.028-3/8", 0.7-10mm Flat End 		1.5-10mm, Chrome Plated 	9 pieces 1.5 - 10mm 
<b>FLH-0057</b>	<b>FLH-0056</b>	<b>SB202403</b>		<b>SB202407</b>	<b>SB233157</b>

Ratchet Combination Wrench		9Pc Ratchet Wrench Set		9Pc Spanner Set		6Pc Spanner Set		7Pc Spanner Set	
<b>Code</b>	<b>Size mm</b>	<b>Code</b>	<b>SB133249</b>	<b>SB202102</b>		<b>SB202106</b>		<b>TSS-7-8/19</b>	
<ul style="list-style-type: none"> <li>SB133211-8 8</li> <li>SB133211-10 10</li> <li>SB133211-13 13</li> <li>SB133211-15 15</li> <li>SB133211-17 17</li> <li>SB133211-19 19</li> </ul> 72 Tooth ratchet needs only 5° of movement to turn a fastener		72 Tooth ratchet needs only 5° of movement to turn a fastener 8, 10, 11, 12, 13, 14, 16, 17, 19mm		9Pc Combination Spanner Set 7, 8, 10, 11, 12, 13, 16, 17, 19mm		6Pc Double Open Ended Spanner Set 6+7, 8+9, 10+11, 12+13, 14+15, 16+17mm		7Pc Piece Tube Spanner Set 8x9 10x11 12x13, 14x15, 16x17, 18x19mm	

47pcs Ratchet/Driver Set		Metric Socket Wrench Kit		Screwdriver Kits		31 Piece Screwdriver Bit Set		Nutdriver Kit - 7 Pieces	
<b>88-0041</b>		<b>22MRA-CV-S</b>		<b>SB156237</b>		<b>CT-2016</b>		<b>SB157243</b>	
<ul style="list-style-type: none"> <li>• 36 Tooth Palm Handle c/w extra grip ring</li> <li>• Compact, convenient bit/Socket holder</li> <li>• Ergonomic anti-slip rubber grip</li> <li>• Carbon Steel Bits &amp; Sockets (CRV)</li> </ul>		Kit Includes: <ul style="list-style-type: none"> <li>• 16pcs 1/2" Dr. Sockets: 10-19, 21-24, 27, 30, 32mm</li> <li>• 2Pcs 1/2" Dr. extensions 3" x 5"</li> <li>• 1Pcs 1/2" Dr. x 3/8" Adapter</li> <li>• 1Pcs 1/2" Dr. Universal joint</li> <li>• 1Pcs 1/2" Dr. (F) Ratchet handle</li> </ul>		16 Piece precision screwdriver set		Screw driver set		Phillips, Flat, Torx and Hex	
								Sizes: 5, 6, 8, 10, 11, 12, 13 Length: 245mm	

## HAND RIVETERS



HR705

HR702

HR710

HR720

- High grade aluminium die cast housing with drop-forged carbon steel upper handle.
- Steel and jaw case are made of chromed, hardened steel plate.

- Carbon steel forged housing and handle with powder coated surface.
- Jaw and jaw case are made of chromed, heat treated steel.
- Designed for industrial use.

- Lever design reduces physical strength for all rivet sizes.
- The three-jaw design can provide better performance with only a change of nose nozzle.

Code	Length (mm)	Rivet Setting Capacity
HR705	265	Up to 4.8mm (3/16") for all materials
HR702	255	Up to 4.0mm (5/32") for all materials and 4.8mm (3/16") for aluminium
HR710	300 Closed/810 Open	Up to 6.4mm (1/4") for all materials
HR720	430	Up to 4.8mm (3/16") for all materials

## BLIND RIVETS

### Aluminium Rivets with Steel Mandrels

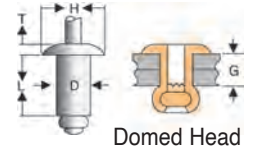
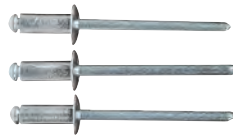

Domed Head

Code	Length		Diameter	Hole Size (mm)	Head Dia	Head Thickness	Standard Strength N. (min.)	
	L	G					Shear	Tensile
AS3.2-8-*	8	3-5	3.2mm	3.3-3.4mm	5.8-6.5	1.2	535	650
AS3.2-10-*	10	5-7						
AS3.2-12-*	12	7-9						
AS4-6-*	6	1.5-2.5	4.0mm	4.1-4.2mm	7.0-8.0	1.5	850	1020
AS4-8-*	8	2.5-4.5						
AS4-10-*	10	4.5-6.5						
AS4-12-*	12	6.5-8.5						
AS4-14-†	14	8.5-10.5	4.8mm	4.9-5.0mm	8.5-9.5	1.6	1160	1420
AS4-18-†	18	12.5-14.5						
AS4.8-10-†	10	4-6						
AS4.8-12-†	12	6-8						
AS4.8-14-†	14	8-10						
AS4.8-18-†	18	12-14						

Add quantity to code: \* 1000 (box packed), 100 (packed in polybag for retail). † 500 (box packed), 100 (packed in polybag for retail).

## DIN RAIL CUTTER

	Guillotine	Dies		Support Guide	
Code	BM2691	BM269112	BM269113	BM26912	BM269122
	Cutter & puncher for rails EN 50035, EN 50022, EN 50045. Designed for extremely rapid, precise and safe cutting & punching of standardised metal frame profiles.	For rail DIN35(DR35) 7.5mm	For rail DIN35(NS35/15) 15mm	Support Guide for BM2691	Support Guide for rail 7.5 & 15mm

## SOLDERING IRONS

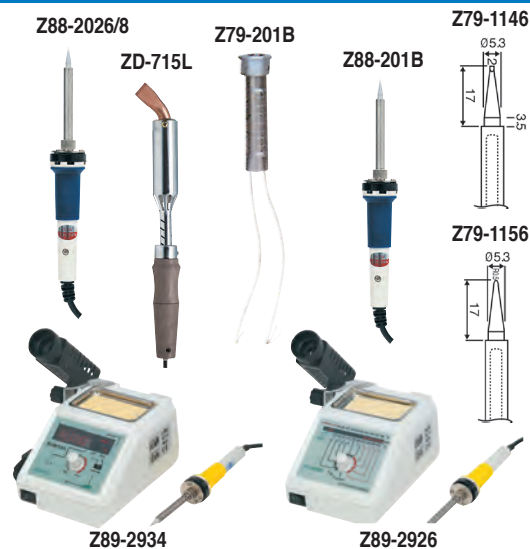

### Soldering Irons

Code	Description	Spare Tips
Z88-2026	30W mains Soldering Iron	Z79-2120
Z88-2028	50W mains Soldering Iron	Z79-2320
ZD-715L-100W	100W mains Soldering Iron	Z79-8504
ZD-715L-200W	200W mains Soldering Iron	Z79-8506
Z89-2934	48W station type Soldering Iron 160°C-480°C digital Spare Element Z79-201B	Z79-1146 Z79-1156
Z89-2926	48W station type Soldering Iron 150°C-420°C Spare Element Z79-201B	Z79-1146 Z79-1156
Z78-201B	Spare Heater Element for Iron Z89-2934 & Z89-2926	-
Z88-201B	Spare Iron for Z89-2934 & Z89-2926	-

### Solder Spools

SN60% PB40%



500g rolls

**SSA08500**

Ø0.7mm

**SSA10500**

Ø0.90mm

**SSA12500**

Ø1.25mm

**SSA20000**

Ø2.0mm

<b>Code</b>	<b>SH-827</b>	<b>SH-814B</b>	<b>SH-60</b>	<b>TAURUS-107</b>	<b>TAURUS-558</b>
	Solder Sucker	50W Soldering Iron stand	50W Electric Solder Sucker	Power: 500W Pot dimensions: 100 x 70 x 45mm Capacity: 2.3kg	Power: 250W Pot dimensions: 55 x 55 x 45mm Capacity 1.2kg
	<b>T-1</b>		<b>SH-60H</b>		
	Spare Tip		Spare element		

## GAS POWERED HEAT TOOLS

<i>All models use Butane gas</i>					
<b>Code</b>	<b>ES-720TH</b>	<b>ES-720SI</b>	<b>ES-650SI</b>	<b>ES-720KB</b>	<b>ES-650KB</b>
Weight	170g	170g	170g with cap	Kit includes:	Kit includes:
Gas Capacity	19ml	19ml	15ml	• ES-720 multi function soldering iron	• ES-650 cordless butane powered soldering iron
Operating Time	90min	90min	50min	• 2.4mm Conical tip	• 2.4mm Chisel tip
Temperature	Up to 1300°C	Up to 480°C	± 200 - 450°C	• 2.4mm Chisel tip	• 3.0mm Diagonal tip
Features	Portable heavy-duty torch Meets U.S. child resistant standard	Portable multi-function soldering iron/heat tool	Cordless butane powered soldering iron/heat tool	• Hot knife tip	• Hot knife tip
Size	180 x 52 x 111mm	180 x 52 x 157mm	237 x 38 x 25mm (with cap)	• Deflector tip	• Heat blower tip
				• Sponge	• Deflector tip
				• Soldering wire	• Sponge
				• Wrench	• Soldering wire

Accessories	Code	Description	Code	Description	Code	Description
	L-016	Conical 1.6mm	L-132	Chisel 3.2mm	L-310	Hot knife
	L-024	Conical 2.4mm	L-1105	Chisel 10.5mm	L-311	Hot knife
	L-124	Chisel 2.4mm	L-230	Diagonal 3.0mm	L-510	Heat blower
			A-BR	Burning room	L-610	Heat deflector

Accessories included with ES-720KB



**CABLE & WIRE STRIPPING TOOLS**

						
Code	STRIP-2	STRIP-3	STRIP-400			
	2-level stripping of all coaxial cables of 4.8 - 7.5mm outer Ø <b>Performance Range:</b> Coaxial 4.8 - 7.5mm Ø Cabtyre 4 x 0.75mm <sup>2</sup> Flexible cables 1.5mm <sup>2</sup> - 16mm <sup>2</sup>	As per STRIP-2 with built-in side cutter	This tool allows circular and horizontal stripping and needs no adjustment of cutting depth. Range: Flex Cables: 4 - 13mm Ø. Solid Conductors: 0.5 - 6mm <sup>2</sup> . Multi-level of coaxial cables: 4 to 8 mm Ø. Built in side-cutter.			
	 <p>FLAT      ROUND</p>					
Code	STRIP-5	STRIP-7-FLAT	STRIP-7	STRIP-300 (Duo - strip/crimp)		
	<ul style="list-style-type: none"> <li>Automatic wire stripper for all common stranded and solid conductors of 0.2 - 6.0 mm<sup>2</sup></li> <li>Adjustable length stop of 5 - 12mm (removable if required)</li> <li>Easily accessible built-in side cutter for max 2mm Ø</li> </ul>	<b>Flat Cables:</b> Cable and wire stripping of two or three core flat cables with PVC insulation from 0.75mm <sup>2</sup> to 4.0mm <sup>2</sup> . <b>Round Cables:</b> Cable and wire stripping of flexible cables in a range of 0.5mm <sup>2</sup> to 16.0mm <sup>2</sup> . Solid conductors from 0.5mm <sup>2</sup> to 10mm <sup>2</sup> . <b>Spare Blade: STRIP7-BLADE (Round)</b>		Three tools in one: Wire Stripper for inner insulations from 0.5 - 6mm <sup>2</sup> ; Crimping of bootlace terminals with two crimping ranges: 0.75mm <sup>2</sup> - 1.5mm <sup>2</sup> and 2.5mm <sup>2</sup> - 6.0mm <sup>2</sup> as well as built-in side cutter for max. 6.0mm <sup>2</sup>		
	 <p><b>NEW</b></p>				 <p>Spare Blade STRIP4-BLADE</p>	
Code	STRIP-SOLAR MINI	STRIP-5-SOLAR PRO	STRIP-7-SOLAR	STRIP4-28H	STRIP-428V	STRIP-428
	<ul style="list-style-type: none"> <li>Stripping depth stop</li> <li>Compact wire stripper designed for the solar industry</li> <li>Suits 1.5-Ø6mm</li> <li>Side blade cutter</li> </ul>	Strip all common solar cables from 1.5-25mm ensures excellent precision & accuracy, the blade of the stripper easily removes multi-layer rubberised insulation. Integrated side cutter suitable for copper & aluminium conductors up to 3mm diameter	An automatic wire stripper for all common round cables used in solar engineering. Precise adjustment allows easy removal of multiple insulation layers of solar cables from 1,5-6mm <sup>2</sup> .	Both circular and longitudinal cuts are possible due to a self-turning strip-ping blade. Accurate, fast and safe stripping of all common round cables of 4 - 28mmØ.	Same as STRIP4-28H, plus: Cable connections, sockets, fuses, circuitry, connecting boxes, lamps and fairy lights etc. can be safely tested for AC voltage by an integral electric potential field sensor. No current flow is required.	Same as STRIP4-28H, plus: This is the first cable stripper of its kind which has an additional hook blade that can be retracted into the tool & be fixed in both positions.
	 <p>• 12 Piece retail counter display stand c/w 12 pieces of STRIP-S428-M</p>		 <p>Round Cable Stripper For all round cables of 8 - 13mm (e.g. 3 x 1.5mm<sup>2</sup> up to 5 x 2.5mm<sup>2</sup>)</p> <p>Stripper For all common stranded and solid conductors of 0.5mm<sup>2</sup> to 6.0mm<sup>2</sup></p> <p>Coax Stripper Two- or three-level stripping of all common coaxial cables fo 4.8 to 7.5 mm outer Ø.</p> <p>Built in side cutter For PVC-insulated round cables of max 9mm<sup>2</sup></p>		 <p>Second bit inside the handle</p> <p>Voltage tester 110 - 250V</p> <p>Two turnable bits 1.PZ1⊗ 3.5 x 0.6m⊗ 2.PZ2⊗ 4.0 x 0.8m⊗</p>	
Code	STRIP-S428-M	STRIP-S428/12-M		STRIP-500		

## CABLE & WIRE STRIPPING TOOLS

	<b>Professional Cable Stripping Starter Kit</b>	
	<b>Code</b>	<b>PRO-STARTER</b>
	Kit includes:	
	<b>STRIP-428:</b> The cable stripper allows precise, quick and safe stripping of all standard round cables with a diameter between 4 and 28 millimeters. Comes with retractable hook blade.	
	<b>STRIP-5:</b> Automatic Wire Stripper. Precise work with adjustable length stop (5 - 12mm). Side cutter up to 2mm diameter.	

**STRIP-13:** For all standard round cables diameter 8 - 13mm. Flush stripping, even in hard to reach places.  
**STRIP-2:** Two-level stripping of all common coaxial cables.

<b>SB201422</b>	<b>SB201426</b>	<b>SB201009</b>	<b>LY-700A</b>	<b>LY-700D</b>
Wire Stripper for cables 0.5-4mm <sup>2</sup>	Wire Stripper for cables 6-16mm <sup>2</sup> 0.75-6mm <sup>2</sup>	For wire 0.5-6.0mm <sup>2</sup>	For wire 0.5-2.0mm <sup>2</sup>	For wire 0.5-6.0mm <sup>2</sup>
			<b>LY-700B</b>	
			For wire 1.0-3.2mm <sup>2</sup>	

## CRIMPING TOOL KITS

	<b>Code</b> YS-03C0-1A	<b>Code</b> HT-914A	
YS-03C0-1A	For boot-lace insulated ferrules 300pcs (0.5-4.0mm <sup>2</sup> ) c/w Tool type YS-03C0	<b>Data Socket Insertion Tool</b>	For data socket use on 66 & 110/88 type connectors
	<b>Code</b> Y-190	<b>Multipurpose Tool</b>	
Y-190	151pcs Mixed Insulated Lugs c/w Tool type KH-502		
	<b>Code</b> Y-202	<b>Code</b> SB201437	
Y-202	120pcs Mixed Insulated Lugs	45pcs Mixed Insulated Lugs c/w Terminal Crimp and Wire Stripper	
	<b>Code</b> Y-200		
Y-200	300pcs Mixed Insulated Lugs		

## BOOT LACE / LUG KITS

<b>Kit for Insulated Lugs</b>	<b>Kit for Boot-Lace Ferrules</b>
<b>Code</b> BM00411	<b>Code</b> BM00412
<b>Kit Includes</b> Tool: BM534	<b>Kit Includes</b> Tool: BM541
<b>Red 1.5mm<sup>2</sup> Insulated :</b> 4mm Ring - 100pcs; 4mm fork - 100pcs; 5mm Ring - 100pcs; 10mm Pin - 100pcs; Ferrules - 100pcs; 6.3mm female disc. - 100pcs; 6.3mm male disc. - 100pcs <b>Yellow 4-6mm<sup>2</sup></b> 5mm Ring - 50pcs; Ferrules - 50pcs; 6mm Ring - 50pcs	<b>Blue 2.5mm<sup>2</sup> Insulated:</b> 4mm Ring - 100pcs; 4mm fork - 100pcs; 5mm Ring - 100pcs; 10mm Pin - 100pcs; Ferrules - 100pcs; 6.3mm female disc. - 100pcs; 6.3mm male disc. - 100pcs; 6.3mm insulated female disc. - 50pcs <b>Bootlace Ferrules Single:</b> 0.75mm <sup>2</sup> white 500pcs; 1mm <sup>2</sup> yellow 500pcs; 1.5mm <sup>2</sup> red 500pcs; 2.5mm <sup>2</sup> blue 250pcs; 4mm <sup>2</sup> grey 200pcs; 6mm <sup>2</sup> black 100pcs; 10mm <sup>2</sup> ivory 50pcs; 16mm <sup>2</sup> green 50pcs <b>Bootlace Ferrules Double:</b> 2 x 0.75mm <sup>2</sup> white 200pcs; 2 x 1mm <sup>2</sup> yellow 200pcs; 2 x 1.5mm <sup>2</sup> red 200pcs; 2 x 2.5mm <sup>2</sup> blue 100pcs; 2 x 4mm <sup>2</sup> grey 100pcs; 2 x 6mm <sup>2</sup> green 50pcs

## CRIMPING TOOLS

	Professional Tools Code BM Type	Description	Economy Tools Code	
	<b>BM534</b>	For insulated lugs (red, blue, yellow)	<b>LY-03C</b>	
	<b>BM537</b> (0.5-4.0mm <sup>2</sup> )	For insulated boot-lace ferrules	<b>LY-04WF</b> (0.5-6.0mm <sup>2</sup> )	
	<b>BM539</b>	For insulated boot-lace ferrules (6-16mm <sup>2</sup> ) For insulated boot-lace ferrules (10-35mm <sup>2</sup> )	<b>LY-16WF</b> <b>LY-35WF</b>	
	<b>BM531</b>	For non insulated auto lugs (0.5-6mm <sup>2</sup> )	<b>LY-03B</b>	
	<b>BM535</b> (0.5 - 10mm <sup>2</sup> )	For non insulated lugs	<b>KH-16</b> (1.25-16mm <sup>2</sup> ) <b>KH-22</b> (5.5-25mm <sup>2</sup> )	
	-	Hex hand crimp for non insulated lugs	<b>HX-16</b> (6-16mm <sup>2</sup> ) <b>HX-26B</b> (6-25mm <sup>2</sup> ) <b>HS-05H</b> (1.5-25mm <sup>2</sup> )	
	<b>BM543</b>	For coaxial connectors for cable RG58-59-62-6	<b>HS-02H</b>	
	<b>BM53816</b> (0.08 - 16mm <sup>2</sup> )	For insulated boot-lace ferrules	<b>HSC8-6-4</b> (0.25 - 6mm <sup>2</sup> ) <b>HSC8-6-6</b> (0.25 - 6mm <sup>2</sup> ) <b>HSC8-16-4</b> (4 - 16mm <sup>2</sup> )	
	<b>BM549</b>	Crimping tool for RJ11, RJ12, RJ45	<b>ZD-501006</b>	

	Code	Description		Code	Description
	<b>BM524</b>	Uninsulated Terminals 0.5-10mm <sup>2</sup>		<b>BM523</b>	Heavy Duty crimping Tool for use with uninsulated terminals 10-120mm <sup>2</sup>
	<b>BM525</b>	Uninsulated Terminals 2.5-16mm <sup>2</sup>			
	<b>BM526</b>	Uninsulated Terminals 6-35mm <sup>2</sup>			
	<b>BM527</b>	Bootlace Terminals 25 - 35 - 50mm <sup>2</sup>			

### Hand Crimping Tools - For uninsulated lugs

	<b>CT-80</b>	Crimping tool with movable & revolving dies 8-80mm <sup>2</sup>
	<b>HX-50B</b>	Hex crimping tool with movable & revolving dies 6-50mm <sup>2</sup>
	<b>HX-150BX</b>	Hex crimping tool with movable & revolving dies 25 - 150mm <sup>2</sup>
	<b>HX-245B</b>	Hex crimping tool with movable & revolving dies 70-240mm <sup>2</sup>
	<b>MT-120</b>	Heavy Duty Point Crimping Tool 16 - 95mm <sup>2</sup>

### Crimping Tool Kit - with exchangeable dies

	Code	BM5345	ZD-922A
		Complete Kit in a carry case for the following applications: <ul style="list-style-type: none"> <li>Insulated Terminals 0.25-6mm<sup>2</sup></li> <li>Boot Lace Terminals 0.5-4mm<sup>2</sup></li> <li>Boot Lace Terminals 6-16mm<sup>2</sup></li> <li>Barrel Open Terminals 0.5-6mm<sup>2</sup></li> <li>Uninsulated Terminals 0.5-10mm<sup>2</sup></li> </ul>	Complete Kit in a carry case for the following applications: <ul style="list-style-type: none"> <li>Insulated Terminals 0.25-6mm<sup>2</sup></li> <li>Boot Lace Terminals 0.5-16mm<sup>2</sup></li> <li>Crimping of uninsulated terminals up to 10mm<sup>2</sup></li> <li>Coaxial Crimping</li> </ul>





## BM HYDRAULIC PUNCHING / CUTTING TOOLS

	Hand Hydraulic Hole Punch	Hydraulic Foot Pump	Cutting Headstock - Guillotine Cutter		Headstock for Punches
<b>Code</b>	<b>BM185</b>	<b>BM1600</b>	<b>BM288</b>	<b>BM289</b>	<b>BM265</b>
	<ul style="list-style-type: none"> <li>Guaranteed 700 bar working Pressure</li> <li>Supplied with Carry Case</li> <li>Max Punch Size: Round 72mmØ Square 68 x 68mm</li> <li>See page 521 for Punching Dies</li> </ul>	<ul style="list-style-type: none"> <li>Quick &amp; Easy Die location with high and low pressure valves, allows for professional finish, due to foot operation.</li> <li>Pressure 700bar Max.</li> <li>Fast 2 Speed Operation</li> </ul>	85mmØ Max Guillotine for Speed Cutting. Use with <b>BM1600</b>	110mmØ Max Guillotine for Speed Cutting. Use with <b>BM1600</b>	Max thickness 3mm. Use with <b>BM1600</b> & Punching Dies on page 521

## HYDRAULIC CRIMPING / CUTTING TOOLS

	Hydraulic Pumps		Crimping Heads		Cable Cutter
	Works with <b>CYO-0410H &amp; SHP-210D &amp; CPC-100</b>	Works with <b>CYO-0410H &amp; SHP-210D &amp; CPC-100</b>	Works with <b>CP-390 &amp; CFP-800-1</b>	Works with <b>CP-390 &amp; CFP-800-1</b>	Works with <b>CP-390 &amp; CFP-800-1</b>
<b>Code</b>	<b>CP-390</b>	<b>CFP-800-1</b>	<b>CYO-410H</b>	<b>SHP-210D</b>	<b>CPC-100</b>
	<ul style="list-style-type: none"> <li>Hand-operated hydraulic pump</li> <li>Internal high pressure protection valve</li> <li>Max output: 700kgf/cm<sup>2</sup> /10 000psi</li> <li>Output range (Psi): 350-10 000</li> <li>Oil capacity: 480cc</li> <li>PT3/8" oil pipe connection</li> </ul>	<ul style="list-style-type: none"> <li>Foot-operated pump</li> <li>Internal high pressure protection valve</li> <li>Max output: 700kgf/cm<sup>2</sup> /10 000psi</li> <li>Output range (Psi): 350-10 000</li> <li>Oil capacity: 650cc</li> <li>PT3/8" oil pipe connection</li> </ul>	<ul style="list-style-type: none"> <li>Cable Size: 35-300mm<sup>2</sup></li> <li>Dies Incl: 35,50, 70, 95, 120, 150,185, 240, 300</li> <li>Output (T): 120kN</li> <li>Ram Stroke: 30mm</li> <li>For use in &amp; outside DB</li> <li>Titanium Alloy Construction</li> </ul>	<ul style="list-style-type: none"> <li>Cable Size: 25-240mm<sup>2</sup></li> <li>Built-in revolving die</li> <li>Output (T): 120kN</li> <li>Ram Stroke: 22mm</li> <li>For use in &amp; outside the DB</li> </ul>	<ul style="list-style-type: none"> <li>Can cut cable up to Ø 100mm depending on the type of material. Solid copper = Ø 42mm</li> <li>Output: 7.5T</li> <li>Length: 570mm</li> <li>Max oil pressure: 700kgf/cm<sup>2</sup> (10 000 psi)</li> <li>PT 3/8" oil pipe capacity</li> <li>Spare Blade: <b>CPC-100-BLADE</b></li> </ul>

### Hydraulic Crimping Tools

### Cable Cutter

	Hydraulic Crimping Tools					Cable Cutter
<b>Code</b>	<b>HP-210D</b>	<b>HP-240F</b>	<b>CYO-510B</b>	<b>YT-22860</b>	<b>YT-22862</b>	<b>YT-22872</b>
Cable Size	25-240mm <sup>2</sup>	25-240mm <sup>2</sup>	50-400mm <sup>2</sup>	10-120mm <sup>2</sup>	16-300mm <sup>2</sup>	4-20mmØ
Dies incl.	Built-in revolving die	16, 25, 35, 50, 70, 95, 120, 150, 185, 240	50, 70, 95, 120, 150, 185, 240, 300, 400	10, 16, 25, 35, 50, 70, 95, 120	16, 25, 35, 50, 70, 95, 120, 150, 185, 240, 300	-
Output	120kN	50kN	130kN	80kN	180-200kN	130kN
Features	<ul style="list-style-type: none"> <li>Rugged heavy duty design</li> <li>Integrated rotatable head bits ensure no misplaced parts</li> <li>Audible warning of high/low pressure</li> <li>Rotatable head 180°</li> </ul>	<ul style="list-style-type: none"> <li>Rotatable head 180°</li> <li>Safety pressure</li> </ul>	<ul style="list-style-type: none"> <li>Rugged heavy duty design</li> <li>Insulated fibreglass handles</li> <li>Auto oil-bypass protection</li> <li>2-stage pumping action</li> <li>Rotatable head 180°</li> </ul>	<ul style="list-style-type: none"> <li>Open cut design for convenient operation</li> <li>Quick die change facility.</li> <li>Supplied with 8pc crimping die set.</li> </ul>	<ul style="list-style-type: none"> <li>Open cut design for convenient operation</li> <li>Quick die change facility.</li> <li>Supplied with 11pcs crimping die set.</li> </ul>	<ul style="list-style-type: none"> <li>Quick &amp; easy cutting</li> <li>Strengthened Carbon Steel Blade</li> <li>Spare blade: <b>YT22875</b></li> </ul>

## BATTERY CRIMPING / CUTTING / PUNCHING TOOLS



### Supplied With

- Dies 16, 25, 35, 50, 70, 95, 120, 150, 185, 240, 300mm<sup>2</sup>
- 2 x Batteries + 1 x Charger (230VAC/18VDC)
- 1 Set Spare Cylinder Seals
- 1 Set Spare Safety Valve Seals
- Spare Battery Code: **BZ18/3AH**

### Crimping Tool

Code	BZ-300
Crimp Size	16-300mm <sup>2</sup>
Crimp Force	60KN
Crimps/Charge	300
Stroke	17mm
Battery	18V / 3Ah



### Supplied With

- Dies 16, 25, 35, 50, 70, 95, 120, 150, 185, 240, 300mm<sup>2</sup>
- Punch Round 22.5, 25.4, 32.5, 40.5, 50.5, 61.5mm
- 2 x Batteries + 1 x Charger (230VAC/18VDC)
- 1 Set Spare Cylinder Seals
- 1 Set Spare Safety Valve Seals
- 1 x Crimping Adaptor & 1 x Punch Adaptor
- Draw studs 3/4", 7/16" + Spacer
- Spare Blade Code: **BZ600-BLADE**
- Spare Battery Code: **BZ18/3AH**

### Crimping / Cutting / Punch Tool

Code	BZ-600UNV
Crimp Size	16-300mm <sup>2</sup>
Crimp Force	60KN
Crimps/Charge	160
Cuts/Charge	70
Cutting Range	Ø40mm (Cu/AL + Armoured)
Punch/Charge	100
Punching Range	Ø22.5mm - Ø61.5mm
Stroke	42mm
Battery	18V / 3Ah



### Supplied With

- Punch/die 22.5, 25.4, 32.5, 40.5, 50.5, 61.5mm
- Draw Studs 1 x 7/16 x 3/4" + 1 x 3/4 x 3/4"
- 2 x Batteries + 1 x Charger (230VAC/18VDC)
- 1 Set Spare Cylinder Seals
- 1 Set Spare Safety Valve Seals
- Spare Battery Code: **BZ18/3AH**

### Punch Tool

Code	BZ-12
Punch Size	61.5Ø / 35 x 65mm
Punch Force	120KN
Punch/Charge	180
Stroke	25mm
Battery	18V / 3Ah

## CABLE CUTTERS



### Cable Cutters for Copper Cable

Code	Description
<b>BM568</b>	For cutting copper cable up to 35mm <sup>2</sup>
<b>BM5681</b>	For cutting copper cable up to 60mm <sup>2</sup>
<b>BM570</b>	For cutting copper cable up to 120mm <sup>2</sup>
<b>BM571</b>	For cutting copper cable up to 240mm <sup>2</sup>
<b>BM572</b>	For cutting copper cable up to 400mm <sup>2</sup>

### Cable Cutters for Aluminium & Copper Cables



Code	Description
<b>LK-22A</b>	For cutting copper & aluminium cables up to 22mm <sup>2</sup>
<b>LK-60A</b>	For cutting copper & aluminium cables up to 60mm <sup>2</sup>
<b>CC-100L</b>	For cutting copper & aluminium cables up to 100mm <sup>2</sup>
<b>HS-325A</b>	For cutting copper & aluminium cables up to 150mm <sup>2</sup>
<b>HS-520A</b>	For cutting copper & aluminium cables up to 240mm <sup>2</sup>
<b>LK-250</b>	For cutting copper & aluminium cables up to 250mm <sup>2</sup>
<b>LK-500</b>	For cutting copper & aluminium cables up to 500mm <sup>2</sup>



LK-500/ LK-250



## BOLT CUTTER

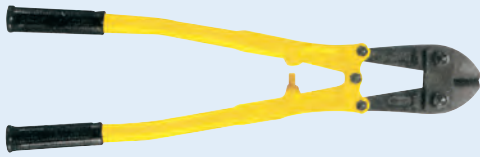

### Heavy Duty Bolt Cutter

Code	Description
HT10-6213	610mm (24") Bolt Cutter
HT10-6214	762mm (30") Bolt Cutter

• Alloy Steel • Tubular Handle • Jaws hardened to HRC55-61

## SHEARS

	X-PRO 50mm <sup>2</sup> Shears	X-PRO Evo 50mm <sup>2</sup> Shears	Cable Shears	Maxi Grip
	 <b>PATENTED RED DOT AWARD</b>			
<b>Code</b>	<b>BM1325</b>	<b>BM1330</b>	<b>BM1335</b>	<b>BM1311</b>
	<ul style="list-style-type: none"> <li>Innovative new spring loaded opening action</li> <li>For the easy stripping and cutting of cables</li> <li>Especially designed blade for cutting of Aluminium &amp; Copper cables up to a size of 50mm<sup>2</sup></li> <li>Belt Clip Holder</li> </ul>	<ul style="list-style-type: none"> <li>Ergonomic Design for stronger grip &amp; increased comfort</li> <li>New design accommodates different hand sizes</li> <li>New reinforced handles</li> <li>Longer lever &amp; micro serrated blades for easier cutting of cables up to 50mm<sup>2</sup></li> </ul>	<ul style="list-style-type: none"> <li>Wire Shears</li> <li>Robust ergonomic handle</li> <li>For the easy cutting and stripping of Aluminium and Copper cables up to a size of 35mm<sup>2</sup></li> <li>Tempered stainless steel blade</li> <li>With safety lock</li> </ul>	<ul style="list-style-type: none"> <li>Wire Shears</li> <li>Bi-Component handle for greater cutting force</li> <li>Non-slip serrated blades</li> <li>Tempered stainless steel blade</li> <li>Belt clip holder</li> </ul>

## ROPE ACCESSORIES

	Eye Bolts			Thimble	Clamp	Tensioner
<b>Code</b>	<b>SB209333/M8</b>	<b>SB209333/M10</b>	<b>SB209333/M12</b>	<b>SB209331/6</b>	<b>SB209332/6.5</b>	<b>SB209336/8</b>
<b>Size</b>	10mm(L)	13mm(L)	16mm(L)	6mm	6.5mm	8mm

## SAND PAPER & SANDING BELTS

### Floor Paper Rolls

Code	Description	Grit	Pcs/Pack	Packs/Box
FP-P60D/1	Floor Paper Strips	P60D	1	25
FP-P80D/1	Floor Paper Strips	P80D	1	25
FP-P100D/1	Floor Paper Strips	P100D	1	25

### Sanding Belts

SB-75x532-P40/2	Sanding Belts - 75 x 532mm	P40	2	12
SB-75x532-P60/2	Sanding Belts - 75 x 532mm	P60	2	12
SB-75x532-P80/2	Sanding Belts - 75 x 532mm	P80	2	12

### Water Paper Sheets

WP-P80C/4	Coarse Water Paper Sheets - 230 x 280mm	P80C	4	25
WP-P120C/4	Medium Water Paper Sheets - 230 x 280mm	P120C	4	25
WP-P222C/4	Fine Water Paper Sheets - 230 x 280mm	P222C	4	25

### Cabinet Paper

CP-P60D/4	Coarse Cabinet Paper Sheets - 230 x 280mm	P60D	4	25
CP-P80D/4	Medium Water Cabinet Sheets - 230 x 280mm	P80D	4	25
CP-P120D/4	Fine Water Cabinet Sheets - 230 x 280mm	P120D	4	25

## POWER TOOL ACCESSORIES - ABRASIVES



### Superflex Standard Cutting Wheel - Metal - Specification: AS30S B27 F2

Code	DIA.	Thickness	Hole Size	Shape	Max Speed		Box QTY
					M/Sec	RPM	
GTCW0001	115	3.0	22.2	41 Flat	80	13280	25
GTCW0002	125	3.0	22.2	41 Flat	80	12280	25
GTCW0003	150	3.0	22.2	41 Flat	80	10190	25
GTCW0004	180	3.0	22.2	41 Flat	80	8600	25
GTCW0005	230	3.0	22.2	41 Flat	80	6600	25



### Superflex Quality Cutting Wheel - Metal (Light Duty Machines 2kw or Less) Specification: AS30R BF2E

Code	DIA.	Thickness	Hole Size	Shape	Max Speed		Box QTY
					M/Sec	RPM	
GTCW0006	350	3.0	25.4	41 Flat	80	4100	10



### Superflex Standard Cutting Wheel - Stone Specification: CS302 B40 F2 (Mainly Used For Wall Chasing)

Code	DIA.	Thickness	Hole Size	Shape	Max Speed		Box QTY
					M/Sec	RPM	
GTCW0009	115	3.0	22.2	41 Flat	80	13280	25
GTCW0011	125	3.0	22.2	41 Flat	80	12280	25
GTCW0013	230	3.0	22.2	41 Flat	80	6600	25



### Superflex Slimline Cutting Wheel - Metal & Stainless Steel (2 in 1) Specification: A46T BF

Code	DIA.	Thickness	Hole Size	Shape	Max Speed		Box QTY
					M/Sec	RPM	
GTCW0014	115	1.0	22.2	T41 Flat	80	13280	25
GTCW0017	125	1.0	22.2	T41 Flat	80	12280	25
GTCW0019	230	1.9	22.2	T41 Flat	80	6600	25



### Superflex Slimline Cutting Wheel - Multi-Purpose - Specification: C60T BF

Code	DIA.	Thickness	Hole Size	Shape	Max Speed		Box QTY
					M/Sec	RPM	
GTCW0021	115	1.0	22.2	T41 Flat	80	13280	25
GTCW0022	230	1.9	22.2	T41 Flat	80	6600	25



### Superflex Standard Angle Grinding Wheel - Metal - Specification: C60T BF

Code	DIA.	Thickness	Hole Size	Shape	Max Speed		Box QTY
					M/Sec	RPM	
GTCW0026	115	6.4	22.2	27 D/CT	80	13280	10
GTCW0032	230	6.0	22.2	27 D/C	80	6600	10

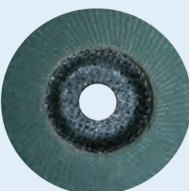

### Industrial Flap Discs

Code	DIA.	Hole	Grit	Box QTY
GTFD0030	115	22	AZ40	10
GTFD0031	115	22	AZ60	10
GTFD0032	115	22	AZ80	10
GTFD0033	180	22	AZ60	10

### DIY Flap Discs

Code	DIA.	Hole	Grit	Box QTY
GTFD0034	115	22	AZ40	10
GTFD0035	115	22	AZ60	10
GTFD0036	115	22	AZ80	10



### Diamond Saw Blades

Code	DIA.	Thickness	Hole Size	Box QTY
GTCW0040	115	2.2/7	22.23	1
GTCW0041	125	2/7	22.23	1
GTCW0042	230	2.2/7	22.23	1

### Segmented Diamond Blade



Code	dxD(mm)
DIA-S-115	115 x 22.23
DIA-S-230	230 x 22.23

**NEW**

## ALPEN DRILL BITS PACK & CHISELS

	Alpen HSS Sprint Master TM6	Alpen Profi Multicut SDS	Alpen Profi Multicut	Force X SDS Set	Force X Cassette SDS-Plus										
	<b>SPRINT MASTER</b> ★★★★	<b>PROFI MULTICUT</b> ★★★★★	<b>PROFI MULTICUT</b> ★★★★★	<b>FORCE X</b> ★★★★★	<b>FORCE X</b> ★★★★★										
<b>Code</b>	<b>ALP811122100</b>	<b>ALP SPM5</b>	<b>ALP PM5</b>	<b>ALP8150681</b>	<b>ALP805000051</b>										
<b>Description</b>	Pack of 6 (2, 3, 4, 5, 6 & 8mm)	Pack of 5 (5/6 x 110mm, 6/8/10 x 160mm)	Pack of 5 (4, 5, 6, 8, 10mm)	Pack of 3 (6/8/10 x 160mm)	Pack of 5 (5/6 x 110mm, 6/8/10 x 160mm)										
	<ul style="list-style-type: none"> <li> Resilient</li> <li> Fast drilling progress</li> <li> Long tool life</li> </ul> <p>Toughness and precision combined with excellent cutting efficiency for drilling alloyed carbon and plain steel. Ideal for hand held operations.</p>	<ul style="list-style-type: none"> <li> Automatic hammer-stop function</li> <li><b>UNI</b> For metal, masonry and tiles</li> <li> Diamond ground, sharp cutting edges</li> </ul> <p>For rotary drilling in tiles, masonry, metal, wood and plastics. Special shank design SDS plus hammer drills with a significantly longer service life.</p>	<ul style="list-style-type: none"> <li> Universal special drill bits</li> <li><b>UNI</b> For metal, masonry and tiles</li> <li> Diamond ground, sharp cutting edges</li> </ul> <p>For precision rotary drilling in tiles, natural stone, metal, wood and plastics. Drill through plastics, metal &amp; masonry in one work step.</p>	<ul style="list-style-type: none"> <li> For reinforced concrete</li> <li> 4 Tungsten carbide cutting edges</li> <li> Dowel length indicator</li> </ul> <p>SDS-plus high performance drill bit. New progressive spiral design. Vibrationless running and fast removal of drilling dust.</p>	<ul style="list-style-type: none"> <li> For reinforced concrete</li> <li> 4 Tungsten carbide cutting edges</li> <li> Dowel length indicator</li> </ul> <p>SDS-plus high performance drill bit. New progressive spiral design. Vibrationless running and fast removal of drilling dust.</p>										
	<b>Alpen F4 SDS Drill Bit Set</b>	<b>Masonry Drill Bit Sets</b>		<b>SDS Plus Drill &amp; Chisel</b>											
	<b>F4 FORTE</b> ★★★★	<b>LONG LIFE</b> ★★★★	<b>LONG LIFE</b> ★★★★												
<b>Code</b>	<b>ALP MB5</b>	<b>ALP TSS3</b>	<b>ALP TSS5</b>	<b>ALP KIT16</b>											
<b>Description</b>	Pack of 5 (5/6 x 110mm, 6/8/10 x 160mm)	Pack of 3 (5, 6, 8mm)	Pack of 5 (4, 5, 6, 8, 10mm)	16 Piece set in Metal Carry Case											
	<ul style="list-style-type: none"> <li> Efficient</li> <li> Fast drilling progress</li> <li> Precise</li> </ul> <p>Patented 4X stepped profile and patented tip. Low wear, very long service life. For heavy-duty drilling in concrete, natural stone &amp; brickwork.</p>	<ul style="list-style-type: none"> <li> Universal percussion drill bits</li> <li> Hard</li> <li> Long tool life</li> </ul> <p>Long Life, milled flutes, for percussion and rotary drilling in concrete, brick and natural stone.</p>	<ul style="list-style-type: none"> <li> Universal percussion drill bits</li> <li> Hard</li> <li> Long tool life</li> </ul> <p>Long Life, milled flutes, for percussion and rotary drilling in concrete, brick and natural stone.</p>	<b>Alpen SDS Plus Chisel</b> <table border="1"> <thead> <tr> <th>Code</th> <th>Description</th> </tr> </thead> <tbody> <tr> <td><b>ALP98002501</b></td> <td>Pointed 250mm</td> </tr> <tr> <td><b>ALP98102501</b></td> <td>Flat 20 x 250mm</td> </tr> <tr> <td><b>ALP98204251</b></td> <td>Flat 40 x 250mm</td> </tr> <tr> <td><b>ALP98302251</b></td> <td>Gouge 250mm</td> </tr> </tbody> </table>		Code	Description	<b>ALP98002501</b>	Pointed 250mm	<b>ALP98102501</b>	Flat 20 x 250mm	<b>ALP98204251</b>	Flat 40 x 250mm	<b>ALP98302251</b>	Gouge 250mm
Code	Description														
<b>ALP98002501</b>	Pointed 250mm														
<b>ALP98102501</b>	Flat 20 x 250mm														
<b>ALP98204251</b>	Flat 40 x 250mm														
<b>ALP98302251</b>	Gouge 250mm														



**NEW**

## ALPEN DRILL BITS

ALPEN HSS SPRINT MASTER			ALPEN Masonry Drill Bits		ALPEN SDS-PLUS Hammer Drill Bits F4		ALPEN FORCE - for Reinforced Concrete		ALPEN Profi Multicut - for Tiles, Natural Stone, Metal, Wood and Plastics			
Size Ø	Code	Length (mm)	Code	Length (mm)	Code SDS	Length (mm)	Code SDS	Length (mm)	Code	Length (mm)	Code SDS	Length (mm)
2.0	ALP61402-1	49	-	-	-	-	-	-	-	-	-	-
2.5	ALP614025-1	57	-	-	-	-	-	-	-	-	-	-
3.0	ALP61403-1	61	ALP11703	-	-	-	-	-	-	-	-	-
3.2	ALP614032-1	65	-	60	-	-	-	-	-	-	-	-
3.5	ALP614035-1	70	-	-	-	-	-	-	-	-	-	-
4.0	ALP61404-1	75	ALP11704	-	-	-	-	-	-	-	-	-
4.2	ALP614042-1	75	-	-	-	-	-	-	-	-	-	-
4.5	ALP614045-1	80	-	75	-	-	-	-	-	-	-	-
5.0	ALP61405-1	86	ALP11705	-	ALP80705	110	ALP805005	110	ALP17205	85	ALP50905	110
-	-	-	-	-	ALP81705	160	ALP815005	160	ALP72905	150	-	-
5.5	-	93	-	85	-	-	-	-	-	-	-	-
6.0	ALP614055-1	93	ALP11706	-	ALP80706	110	ALP805006	110	ALP17206	100	ALP50906	110
-	ALP61406-1	-	ALP36706	-	ALP81706	160	ALP815006	160	ALP72906	200	-	-
-	-	-	-	100	ALP83706	260	ALP835006	260	-	-	-	-
6.5	ALP6180065	101	-	200	ALP837065	260	-	-	-	-	-	-
7.0	ALP6180070	109	ALP11707	-	-	-	-	-	-	-	-	-
8.0	ALP6180080	117	ALP11708	-	ALP81708	160	ALP815008	160	ALP17208	120	ALP51908	160
-	-	-	ALP36708	100	ALP83708	260	ALP835008	260	ALP72908	200	ALP52908	210
-	-	-	-	120	-	-	ALP845008	310	-	-	-	-
8.5	ALP6180085	117	-	200	-	-	-	-	-	-	-	-
9.0	ALP6180090	125	-	-	-	-	-	-	-	-	-	-
10.0	ALP6180100	133	ALP11710	-	-	-	ALP815010	160	ALP17210	120	ALP51910	160
-	-	-	ALP36710	-	ALP81710	160	ALP835010	260	ALP72910	200	ALP52910	210
-	-	-	-	120	ALP83710	260	ALP845010	310	ALP73010	400	-	-
12.0	ALP6180120	151	ALP11712	200	-	-	ALP815012	160	ALP73012	400	ALP52912	210
-	-	-	ALP36712	-	ALP81712	160	ALP835012	260	-	-	-	-
-	-	-	-	150	ALP83712	260	ALP845012	310	-	-	-	-
13.0	ALP618013	151	ALP11713	200	-	-	-	-	-	-	-	-
14.0	ALP6400140	160	ALP11714	-	-	-	ALP815014	160	-	-	-	-
-	-	-	-	150	ALP81714	160	ALP845014	310	-	-	-	-
15.0	-	-	ALP11715	150	ALP83714	260	-	-	-	-	-	-
16.0	ALP6400160	178	ALP11716	-	ALP83715	260	ALP815016	160	ALP73016	400	-	-
-	-	-	-	150	ALP81716	160	ALP845016	310	-	-	-	-
18.0	-	-	ALP11718	150	ALP83716	260	-	-	-	-	-	-
20.0	-	-	-	-	ALP83718	260	-	-	-	-	-	-

- Resilient
- Fast drilling progress
- Long tool life

Toughness and precision combined with excellent cutting efficiency for drilling alloyed carbon and plain steel. Ideal for hand held operations.

- Universal percussion drill bits
- Hard
- Long tool life

Long Life, milled flutes, for percussion and rotary drilling in concrete, brick and natural stone.

- Efficient
- Fast drilling progress
- Precise

Patented 4X stepped profile and patented tip. Low wear, very long service life. For heavy-duty drilling in concrete, natural stone & brickwork.

- For reinforced concrete
- 4 Tungsten carbide cutting edges
- Dowel length indicator

SDS-plus high performance drill bit. New progressive spiral design. Vibrationless running and fast removal of drilling dust.

- Universal special drill bits
- UNI
- Diamond ground, sharp cutting edges

For precision rotary drilling in tiles, natural stone, metal, wood and plastics. Drill through plastics, metal & masonry in one work step.

- Automatic hammer-stop function
- UNI
- Diamond ground, sharp cutting edges

For rotary drilling in tiles, masonry, metal, wood and plastics. Special shank design SDS plus hammer drills with a significantly longer service life.

TEST INSTRUMENTS, TOOLS & GENSETS

## DRILL SETS

Twist Drill Sets				Masonry Drill Set	Jigsaw Blades	3pc Step Drill Bit Set
	13 Pcs 	19 Pcs 	25 Pcs 			
10 Pcs				4 Pcs	5 Pcs	<b>NEW</b>
<b>TX-H1001</b>	<b>TX-H1302-1</b>	<b>TX-H1902-1</b>	<b>TX-H2502</b>	<b>TX-M402-1</b>	<b>T118A</b>	<b>K-3240A</b>
1 to 10mm (1mm Increments)	1.5 to 6.5 (0.5 Increments) + 3.2 & 4.8mm	1.0 to 10.0mm (0.5mm Increments)	1.0 to 13.0mm (0.5mm Increments)	4, 5, 6, 8mm Ø ZN-Plated	For Metal 1-3mm	Material: HSS4241   Hardness: HRC 60-63   Surface: Titanium Plated 5 Steps: 4, 6, 8, 10, 12mm 9 Steps: 4, 6, 10, 12, 14, 16, 18, 20mm 15 Steps: 4, 6, 8, 10, 12, 14, 16, 18, 20, 22, 24, 26, 28, 30, 32mm

## HOLE SAWS

		Fixed Hole Saws	Bi-Metal Hole Saws	Tungsten Carbide Tip (TCT)	
<ul style="list-style-type: none"> <li>High Speed Bi-Metal Edge welded to alloy steel for heavy duty cutting</li> </ul>					
Size Ø (mm)	Size Ø (Inches)	Code	Code	Code	Size Ø (mm)
16	5/8"	-	HS-16	<b>TCT16</b> <b>NEW</b>	16
20	25/32"	<b>TX-20</b>	HS-20	<b>TCT20</b>	20
22.5	7/8"	<b>TX-22</b>	HS-22.5	<b>TCT22.5</b>	22.5
25	1"	<b>TX-25</b>	HS-25	<b>TCT25</b>	25
29	1 1/8"	-	HS-29	<b>TCT32</b>	32
30	1 1/16"	<b>TX-30</b>	HS-30	<b>TCT40</b>	40
32	1 1/4"	-	HS-32	<b>TCT50</b>	50
35	1 3/8"	-	HS-35		
38	1 1/2"	-	HS-38		
40	1 9/16"	-	HS-40		
44	1 3/4"	-	HS-44		
48	1 7/8"	-	HS-48		
51	2"	-	HS-51		
54	2 1/8"	-	HS-54		
57	1 1/4"	-	HS-57		
60	2 3/8"	-	HS-60		
64	2 1/2"	-	HS-64		
73	2 7/8"	-	HS-73		
76	3"	-	HS-76		

- Complete with Arbor & Spring Extractor
- Fast cuts
- Stainless & all high alloy steels + Fibre Glass
- Long service Life

**Arbors** - For use with HS Hole Saws



**HAS-02**

- Shank Size: 3/8" Hex
- Thread Size: 1/2"
- Fits to 16 - 30mm Hole Saw



**HAS-04**

- Shank Size: 7/16" Hex
- Thread Size: 5/8"
- Fits to 32 - 76mm Hole Saw

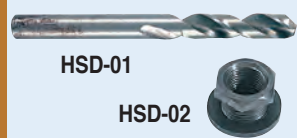

### Accessories

Code	Description	Ø Size (mm)
<b>HSD-01</b>		
<b>HSD-02</b>		
<b>HSD-01/10</b>	10pcs Spare Drill Bit for <b>HAS-02</b> & <b>HAS-04</b>	6.35 x 73
<b>HSD-02</b>	Adaptor for different Arbor Thread Size	1/2" - 5/8"

### 9 Piece Hole Saw Kit

Code	HSD-04
Includes	6 x Hole Saws: 16mm (5/8"), 20mm (25/32"), 25mm (1"), 32mm (1 1/4"), 40mm (1 9/16"), 51mm (2")  2 x Arbors to fit Hole Saw: 1/4" Hex to fit 16 - 30mm 7/16" Hex to fit 32 - 210mm  1 x Adaptor 1/2" - 5/8"



### 16 Piece Hole Saw Kit

Code	HSD-16
Includes	12 x Hole Saws: 19mm (3/4"), 22mm (7/8"), 29mm (1 1/8"), 32mm (1 1/4"), 38mm (1 1/2"), 44mm (1 3/4"), 51mm (2"), 64mm (2 1/2"), 76mm (3"), 89mm (3 1/2"), 102mm (4"), 127mm (5")  2 x Arbors 3/8" & 1/4" Hex with one 6mm pilot drill & 2.5mm allen key  1 x Drive plate



## DRILLS & TAPS

High speed Drills (DIN338)		High speed Drills		SDS Plus						SDS Max		
Size Ø	Yellow Steel Drills		Masonry Drills (ZN-Plated)				1st Cut Taps	Req Drill Size	1st,2nd&3rd Cut Taps (Set)	Masonry Drills (ZN-Plated)		
	Code	Length (mm)	Code	Length (mm)	Code	Length (mm)				Size Ø	Code	Length (mm)
Pack size	Pack of 10		Pack of 5		Each		Each		Set of 3	Each		
1.0	HSS-1	34								16.0	BP-C16-340	340
1.5	HSS-1.5	40								16.5		
2.0	HSS-2.0	49								17.0		
2.5	HSS-2.5	57								17.5		
3.0	HSS-3.0	61	MAS-3/5	60			TAP-3/1	2.5	TAP-3/3	18.0	BP-C18-340	340
3.2	HSS-3.2	65								18.5		
3.5	HSS-3.5	70								20.0	BP-C20-340	340
4.0	HSS-4.0	75	MAS-4/5	75	BP-C4-160	160	TAP-4/1	3.2	TAP-4/3	20.5		
4.2	HSS-4.2	75								22.0	BP-C22-340	340
4.5	HSS-4.5	80								22.5		
5.0	HSS-5.0	86	MAS-5/5	85	BP-C5-160	160	TAP-5/1	4.2	TAP-5/3	24.0	BP-C24-340	340
5.5	HSS-5.5	93	Each		BP-C5.5-160	160				24.5		
6.0	HSS-6.0	93	MAS-6	100	BP-C6-160	160	TAP-6/1	5.0	TAP-6/3	25.0	BP-C25-570	570
6.5	HSS-6.5	101								25.5		
	Pack of 5									28.0	BP-C28-570	570
6.8	HSS-6.8	109								28.5		
7.0	HSS-7.0	109	MAS-7	120						30.0	BP-C30-570	570
7.5	HSS-7.5	109								30.5		
8.0	HSS-8.0	117	MAS-8	120	BP-C8-160	160	TAP-8/1	6.8	TAP-8/3	32.0	BP-C32-570	570
8.5	HSS-8.5	117								32.5		
9.0	HSS-9.0	125								35.0		
9.5	HSS-9.5	125								35.5		
10.0	HSS-10.0	133	MAS-10	120	BP-C10-210	210	TAP-10/1	8.5	TAP-10/3	37.0		
10.2	HSS-10.2	133								37.5		
11.0	HSS-11.0	142								38.0		
12.0	HSS-12.0	151	MAS-12	150	BP-C12-210	210				38.5		
13.0	HSS-13.0	151			MAL-13	260				40.0		
14.0	HSS-14.0	160	MAS-14	150	BP-C14-210	210				40.0		

**Drill Bit Kit - 101 Piece Kit**

Code	LB-013		
Includes	19pcs - Hss Drills	1pc - Counter Sinking Bit	10pcs - Nut Drivers
	3pcs - Hss drills with Hex Shank	3pcs - Screw Finder	15pcs - 50mm Driver Bits
	4pcs - Hole Saw	22pcs - Miscellaneous Driver Bits	1pc - Magnetic Bit Holder
	5pcs - Flat Wood Drills	6pcs - Masonry Drills	
	6pcs - Wood Drills	4pcs - Drill Stopper	

Drill Press	16 pcs Tap & Die Set	Impact Chisel	Keyless Drill Chuck																											
<p>Variable spindle</p>	<p><b>TX-0802</b> Tap &amp; Die Size: M3, M4, M5, M6, M8, M10, M12 1 x Tap Wrench / 1 x Die Handle</p>	<p><b>MI-F25-280</b> 280(L) x 25(B)mm</p>	<p><b>CTDCP0023</b></p> <table border="1" style="width: 100%; border-collapse: collapse;"> <tr><td>Type</td><td>Keyless</td></tr> <tr><td>Capacity</td><td>2-13mm</td></tr> <tr><td>Female Thread</td><td>3/8-24UNF</td></tr> <tr><td>Diameter</td><td>43mm</td></tr> <tr><td>Min Length</td><td>63mm</td></tr> <tr><td>Max Length</td><td>76mm</td></tr> </table>	Type	Keyless	Capacity	2-13mm	Female Thread	3/8-24UNF	Diameter	43mm	Min Length	63mm	Max Length	76mm															
Type	Keyless																													
Capacity	2-13mm																													
Female Thread	3/8-24UNF																													
Diameter	43mm																													
Min Length	63mm																													
Max Length	76mm																													
<table border="1" style="width: 100%; border-collapse: collapse;"> <tr><th>Code</th><td>ZJQ4116-A1</td></tr> <tr><td>Power</td><td>500W</td></tr> <tr><td>Speed</td><td>390 - 2600rpm</td></tr> <tr><td>Spindle travel</td><td>50mm</td></tr> <tr><td>Overall height</td><td>630mm</td></tr> <tr><td>Chuck</td><td>13mm</td></tr> </table>	Code	ZJQ4116-A1	Power	500W	Speed	390 - 2600rpm	Spindle travel	50mm	Overall height	630mm	Chuck	13mm	<p><b>Tap Wrench</b></p> <p>M1-M8 M3-M12</p> <table border="1" style="width: 100%; border-collapse: collapse;"> <tr><th>Code</th><th>Length</th><th>For Size</th></tr> <tr><td>D312-001</td><td>125mm</td><td>M1-M8</td></tr> <tr><td>D312-003</td><td>200mm</td><td>M3-M12</td></tr> </table>	Code	Length	For Size	D312-001	125mm	M1-M8	D312-003	200mm	M3-M12	<p><b>Drill Sharpener</b></p> <p>For Drills 3.6 - 10mmØ</p> <table border="1" style="width: 100%; border-collapse: collapse;"> <tr><th>Code</th><th>Description</th></tr> <tr><td>SND401</td><td>Drill</td></tr> <tr><td>SND-STONE</td><td>Spare Stone</td></tr> </table>	Code	Description	SND401	Drill	SND-STONE	Spare Stone	
Code	ZJQ4116-A1																													
Power	500W																													
Speed	390 - 2600rpm																													
Spindle travel	50mm																													
Overall height	630mm																													
Chuck	13mm																													
Code	Length	For Size																												
D312-001	125mm	M1-M8																												
D312-003	200mm	M3-M12																												
Code	Description																													
SND401	Drill																													
SND-STONE	Spare Stone																													



**PROFESSIONAL POWER TOOLS**

**Impact Drills**

				
<b>Code</b>	<b>GSB-570</b>	<b>GSB-16-RE</b>	<b>GSB-16-RE</b>	<b>GSB-18-2-RE</b>
Power	570W	600W	701W	800W
No Load Speed	50 - 3000rpm	0 - 2800rpm	0 - 3000rpm	0 - 3000 rpm
Impact Speed	48000bpm	—	—	0- 48000 rpm
Chuck Size	Keyless Chuck 13mm	1.5 - 13mm	1.5 - 13mm	1.5 - 13mm
Variable Speed	—	Yes	Yes	Yes
Weight	1.7kg	1.7kg	1.9kg	2.6kg

**Rotary Hammer Drills**





			
<b>Code</b>	<b>GBH-220</b>	<b>GBH-12-52D</b>	<b>GBH-5-40D</b>
Power	720W	1700W	1100W
No Load Speed	0 - 4800rpm	0 - 220rpm	170 - 340rpm
Air Flow	—	1750 - 2150ipm	—
Chuck Size	SDS-Plus	SDS-Max	SDS-Max
Weight	2.3kg	11.5kg	6.8kg

**Cordless Impact Drill**

**Cordless Impact Drill/Driver**

**Cordless Drill/Driver**

**Cordless Blower**

				
<b>Code</b>	<b>GSB-185-LI</b>	<b>GSB-18-V-50</b>	<b>GSR-180-LI</b>	<b>GBL-18V-120</b>
Power	21 / 50Nm	28 / 50Nm	45 / 19Nm	—
No Load Speed	0-500 / 0-1900rpm	0-500 / 0-1800rpm	0-400 / 1300rpm	1700rpm
Impact Speed	27000bpm	27000bpm	—	I:8 min/Ah II: 3,5 min/Ah
Chuck Size	1.5 - 13mm	1.5 - 13mm	1.5 - 10mm	—
Speed	Selectable	Selectable	Selectable	270 km/h
Weight	0.99kg	1.1kg	1.4kg	1.1kg

**Angle Grinders**

				
<b>Code</b>	<b>GWS-700</b>	<b>GWS-9-125</b>	<b>GWS-17-125-CI</b>	<b>GWS-22-230-H</b>
Power	710W	900W	1700W	2200W
No Load Speed	12000rpm	11000rpm	11500rpm	6500rpm
Impact Speed	M14	M14	M14	M14
Chuck Size	115mm	125mm	125mm	230mm
Weight	1.7kg	1.9kg	2.4kg	5.2kg

## PROFESSIONAL POWER TOOLS

	Angle Grinders	Blower	Heat Gun
			
<b>Code</b>	<b>GWS-26-230-B</b>	<b>GBL-800-E</b>	<b>GHG-23-66</b>
Power	2600W	820W	2300W
No Load Speed	6500rpm	16000rpm	Temp: 50 - 650°C
Spindle Size	M14	—	250 - 500l/min
Disc Diameter	230mm	—	—
Blow Rate	—	4.5m³/h	—
Weight	5.2kg	1.8kg	0.67kg
	Sabre Saw	Jig Saw	Metal Cut-Off Tool
			
<b>Code</b>	<b>GSA-120</b>	<b>GST-150-BCE</b>	<b>GCO-2000</b>
Power	1200W	780W	2000W
No Load Speed	0 - 3000rpm	500 - 3100rpm	3500rpm
Features	Stroke 28mm Cutting Depth wood 230mm Cutting Depth metal 20mm	26mm Cutting Depth wood 150mm Cutting Depth Alu 20mm	Disc Ø: 355mm Spindle Lock Cut Capacity L <sup>0</sup> 138x138mm
Weight	3.7kg	2.7kg	17kg

## DIY POWER TOOLS



	Glue Gun	Heat Gun	Jig Saw
			
<b>Code</b>	<b>PKP-18-E</b>	<b>PHG-500-2</b>	<b>PST-650</b>
Power	200W / 16W	1600W	500W
Features	Temp 200°C Glue stick Ø11mm Glue Capacity 20gr/min	Temp 300/500°C Air flow 240/450l/min Thermal trip	Speed 3100spm Cutting depth Wood 65mm Cutting depth Steel 4mm
Weight	0.35kg	0.75kg	1.6kg



**NEW**

**20V CORDLESS POWER TOOLS**

**Brushless Hammer Drills**

2 Year Standard Warranty Extendable for 1 Additional Year by Online Warranty						
<b>Code</b>	<b>KUC30</b>	<b>KUC30.1</b>	<b>KUC35</b>		<b>KUC50.2</b>	
No Load Speed	0-500/0-2100rpm		0-550/0-2000rpm		0-1700rpm	
Chuck Size	13mm		13mm		SDS+	
Battery Included	4.0Ah x 2	2.0Ah x 2	4.0Ah x 2		4.0Ah x 2	
Impact Energy	-		-		1.7J	
Impact Rate	0-33600bpm		0-10450/0-38000 bpm		0-5300 bpm	
Max Torque	60Nm		150Nm		-	
Max.Driving/ Drilling Capacity	Steel 13mm, Wood 35mm, Concrete 10mm		Steel 16mm, Wood 152mm, Concrete 16mm		Steel 13mm, Wood 20mm, Concrete 20mm	
Accessories Included	<ul style="list-style-type: none"> <li>• Charger 6A</li> <li>• Double ended bit</li> <li>• Hook</li> <li>• Bit clip</li> <li>• Stacking Case</li> </ul>		<ul style="list-style-type: none"> <li>• Charger 6A</li> <li>• Auxiliary handle</li> <li>• Double ended bit</li> <li>• Hook</li> <li>• Bit clip</li> <li>• Stacking Case</li> </ul>		<ul style="list-style-type: none"> <li>• Charger 6A</li> <li>• Keyless Chuck with SDS adaptor</li> <li>• Stacking Case</li> </ul>	
Features	<ul style="list-style-type: none"> <li>• Maximum 60Nm of torque at 33600 impacts per min</li> <li>• Auto spindle lock for easy bit changes</li> <li>• Robust heavy duty 13mm metal chuck</li> <li>• Variable 2-speed gear control</li> <li>• LED with pre-light function</li> <li>• Forward &amp; reverse rotation control</li> </ul>		<ul style="list-style-type: none"> <li>• Anti kickback technology reduces the risk of injury due to sudden torque change</li> <li>• Constant speed without loss of efficiency during work load</li> <li>• High strength gear &amp; aluminium front housing</li> <li>• LED with pre-light function</li> <li>• Robust heavy duty 13mm metal chuck</li> </ul>		<ul style="list-style-type: none"> <li>• Pulse assist function for drilling into ceramic tile</li> <li>• 3 Operating functions: drilling, hammer drilling &amp; driving</li> <li>• Electronic safety clutch</li> <li>• SDS+ chuck enables easy bit changes</li> <li>• Variable speed with reverse function trigger</li> <li>• LED light</li> </ul>	

**Brushless Impact Wrench/Driver**

**12V Combo Kit**

2 Year Standard Warranty Extendable for 1 Additional Year by Online Warranty						
<b>Code</b>	<b>KUB33.91</b>		<b>KUB61.91</b>		<b>KUG02</b>	
No Load Speed	0-900/0-1100/0-1900rpm		0-1200/0-2100/0-2800/ 0-3600rpm		<b>Hammer Drill</b>	<b>Impact Driver</b>
Chuck Size	1/2"		1/2"		0-1800rpm	0-3300rpm
Battery Included	-		-		10mm	1/4" Hex
Impact Rate	0-1000/0-1600/0-2400bpm		0-1500/0-2800/0-3400/0-4200bpm		2 x 12V 2.0Ah	
Max Torque	1300Nm Max		230Nm Max		0-27000bpm	0-4000bpm
Accessories Included	<ul style="list-style-type: none"> <li>• Carry Strap</li> <li>• Stacking Case</li> <li>* Battery &amp; Charger not Included</li> </ul>		<ul style="list-style-type: none"> <li>• Bit Clip</li> <li>• Hook</li> <li>• 50mm screwdriver bit</li> <li>• Stacking Case(S)</li> <li>* Battery &amp; Charger not Included</li> </ul>		<ul style="list-style-type: none"> <li>• 1.5A Charger</li> <li>• Stacking Case</li> <li>• Spare Battery: <b>KPB1202</b> - 12V 2.0Ah</li> <li>• Spare Charger: <b>KCH1202</b> - 12V 1.5A</li> </ul>	
Features	<ul style="list-style-type: none"> <li>• Mega Force technology always ensures constant torque supply</li> <li>• Features Auto stop function which stops rotation after loosening bolts</li> <li>• 4 mode settings suit for various application (3 speed + auto stop)</li> <li>• LED with pre-light function</li> <li>• Convenient carry strap</li> </ul>		<ul style="list-style-type: none"> <li>• Most compact impact driver in the 20V max category.</li> <li>• Aluminium gear housing for durability &amp; prolonged life.</li> <li>• 4x mode variations: Wood mode, T-mode thick metal plate, T-mode thin metal plate &amp; Bolt mode to cover all your driving &amp; fastening requirements.</li> <li>• Rubberized soft grip provides increased comfort on the job.</li> <li>• LED light</li> </ul>		<ul style="list-style-type: none"> <li>• Brushless motor technology: compact size, longer motor life &amp; increased run time</li> <li>• Compact design makes it perfect for accessing tight spaces</li> <li>• Variable speed for a wide range of fastening applications</li> <li>• Soft grip handle for comfortable to use</li> <li>• Built-in power indicator shows the battery capacity</li> <li>• LED light</li> </ul>	



**NEW**

**20V CORDLESS POWER TOOLS**







	Brushless Reciprocating Saw	Brushless Jigsaw	Brushless 140mm Circular Saw
2 Year Standard Warranty			
Extendable for 1 Additional Year by Online Warranty			
<b>Code</b>	<b>KUE01.9</b>	<b>KUE26.91</b>	<b>KUE11</b>
No Load Speed	0-1400rpm	350-3500rpm	0-6900rpm
Bevel Capacity	-	0-45°	0-50°
Stroke Length	29mm	26mm	-
Cutting Capacity	Wood 300mm Steel 12mm	Wood 135mm Steel 10mm	0°51mm 45°35mm
Battery Included	-	-	-
Variable Speed Switch	Yes	Yes	No
Accessories Included	<ul style="list-style-type: none"> <li>• Wood cutting saw blade</li> <li>• Metal cutting blade</li> <li>* Battery &amp; Charger not Included</li> </ul>	<ul style="list-style-type: none"> <li>• Wood cutting blade</li> <li>• Stacking Case</li> <li>* Battery &amp; Charger not Included</li> </ul>	<ul style="list-style-type: none"> <li>• Parallel guide</li> <li>• Carry strap</li> <li>• Vacuum adaptor</li> <li>• 24T TCT 140mm saw blade</li> </ul>
Features	<ul style="list-style-type: none"> <li>• SDS tool-less blade change for quicker blade changes</li> <li>• Soft no load start</li> <li>• Up to 3000rpm loading speed &amp; 29mm stroke length</li> <li>• Pendulum function for improved performance &amp; cutting versatility</li> <li>• Aluminium gearbox &amp; rubber over mould grip</li> <li>• LED light</li> </ul>	<ul style="list-style-type: none"> <li>• Automatic speed adjustment in 6 steps</li> <li>• 3 Stage pendulum setting</li> <li>• Anti-vibration technology</li> <li>• SDS Tool-less blade change</li> <li>• Aluminium gearbox &amp; rubber over mould grip</li> <li>• LED with pre-light function</li> </ul>	<ul style="list-style-type: none"> <li>• Brushless motor technology</li> <li>• Slim, light weight &amp; compact body design for one-handed operation</li> <li>• Quick cutting depth adjustment for easy depth setting</li> <li>• Electronic brake &amp; alloy gearbox</li> <li>• LED light</li> </ul>
	<b>Grinders</b>		<b>Multitool</b>
			
<b>Code</b>	<b>KUH02.2</b>	<b>KUH04</b>	<b>KUD12.91</b>
No Load Speed	3500/6000/8500rpm	3500/6000/8500rpm	8000 - 18000 min.
Spindle Size	M14	M14	-
Battery Included	4.0Ah x 2		-
Disc Diameter	115mm	125mm	-
Bore Diameter	22.2mm	22.2mm	-
Oscillation Angle	-	-	3.2
Speed Selection	-	-	6
Accessories Included	<ul style="list-style-type: none"> <li>• Auxilliary handle</li> <li>• Spanner</li> <li>• Grinding wheel guard</li> <li>• Charger 6A</li> <li>• Stacking case</li> </ul>	<ul style="list-style-type: none"> <li>• Auxilliary handle</li> <li>• Spanner</li> <li>• Grinding wheel guard</li> <li>• Charger 6A</li> <li>• Stacking case</li> </ul>	<ul style="list-style-type: none"> <li>• Sanding paper #40,#80,#120)</li> <li>• 45mm Presion wood</li> <li>• 28mm end cut blade</li> <li>• Sanding pad</li> <li>• HSS semicircle saw blade</li> <li>• 10mm end cut blade</li> <li>• Rigid scraping blade</li> <li>• Smaller Plange</li> </ul>
Features	<ul style="list-style-type: none"> <li>• 3 Speed settings to suit a variety of grinding jobs</li> <li>• Anti-restart &amp; soft start functions</li> <li>• Detachable grate prevents debris from dam aging the motor</li> <li>• Anti-vibration Auxilliary handle &amp; rubber over mould grip</li> <li>• Tool free quick guard adjustment</li> </ul>	<ul style="list-style-type: none"> <li>• 3 Speed setting selection to suit the application</li> <li>• Anti-restart &amp; soft start functions</li> <li>• Detachable grate prevents debris from damaging the motor</li> <li>• Rubber overmould grip</li> <li>• Tool free quick guard adjustment</li> <li>• Paddle switch &amp; brake function ensure safety</li> </ul>	<ul style="list-style-type: none"> <li>• Longer runtime, greater power increased motor life</li> <li>• Tool-less system easy for blade change.</li> <li>• Low weight universal tool holder, balance and compact design.</li> <li>• LED light for dark work areas.</li> <li>• Anti vibration technology ergonomic tool design.cutting, sawing, scrapping, grinding, polishing &amp; removal.</li> </ul>

**NEW**

**20V CORDLESS POWER TOOLS**

	Blower	Fan	Wet-Dry Vacuum Cleaner
2 Year Standard Warranty Extendable for 1 Additional Year by Online Warranty			
<b>Code</b>	<b>KUF30.9</b>	<b>KU066.9</b>	<b>KH035.9</b>
No Load Speed	0-18000rpm	0-2500rpm	-
Air Volume	1.6m³/2.2m³/2.8m³/min	9m³/12.8m³/min	High 1.3m³/min, Low 0.7m³/min
Fan ø	-	242mm	-
Speed Settings	3 Speed	2 Speed	2 Speed
Accessories Included	<ul style="list-style-type: none"> <li>• Blower tube</li> <li>• Dust Cover</li> <li>• Blowing mouth</li> <li>• Small hose x2 (ø6, ø8)</li> <li>• Quick change connector x2</li> <li>* Battery &amp; Charger not included</li> </ul>	<ul style="list-style-type: none"> <li>• AC Adaptor</li> <li>* Battery &amp; Charger not included</li> </ul>	<ul style="list-style-type: none"> <li>• 3.6m Built in hose</li> </ul>
Features	<ul style="list-style-type: none"> <li>• Powerful maximum 290Km/hr airspeed</li> <li>• Strong blowing force with 3 speed settings to suit the required application</li> <li>• Compact &amp; light weight design with ergonomic handle</li> </ul>	<ul style="list-style-type: none"> <li>• 360 degree angle tilt for customers needs</li> <li>• Battery pack can be charged under AC mode</li> <li>• Switching from AC to DC mode easily</li> <li>• Multiple hanging options for various convenience</li> </ul>	<ul style="list-style-type: none"> <li>• Wireless wristband remote control start-off and speed and the Bluetooth i-connect system</li> <li>• Wheels. Easy for transportation</li> <li>• Tank capacity wet 10L, dry 8L</li> <li>• Blower function</li> <li>• HEPA filter</li> </ul>

**BATTERIES & CHARGERS**

	KROSSPACK™ 20V Chargers		KROSSPACK™ 20V Battery & Charger Kit							
2 Year Standard Warranty				<table border="1"> <tr> <td><b>Code</b></td> <td><b>KAD21</b></td> </tr> <tr> <td>Charging Times</td> <td> <ul style="list-style-type: none"> <li>• 2.0 Ah battery approx. 22mins</li> <li>• 4.0 Ah battery approx. 45mins</li> <li>• 6.0 Ah battery approx. 65mins</li> </ul> </td> </tr> <tr> <td>Kit Includes</td> <td> <ul style="list-style-type: none"> <li>• 4.0 Ah battery x2</li> <li>• 6A Charger</li> </ul> </td> </tr> </table>	<b>Code</b>	<b>KAD21</b>	Charging Times	<ul style="list-style-type: none"> <li>• 2.0 Ah battery approx. 22mins</li> <li>• 4.0 Ah battery approx. 45mins</li> <li>• 6.0 Ah battery approx. 65mins</li> </ul>	Kit Includes	<ul style="list-style-type: none"> <li>• 4.0 Ah battery x2</li> <li>• 6A Charger</li> </ul>
<b>Code</b>	<b>KAD21</b>									
Charging Times	<ul style="list-style-type: none"> <li>• 2.0 Ah battery approx. 22mins</li> <li>• 4.0 Ah battery approx. 45mins</li> <li>• 6.0 Ah battery approx. 65mins</li> </ul>									
Kit Includes	<ul style="list-style-type: none"> <li>• 4.0 Ah battery x2</li> <li>• 6A Charger</li> </ul>									
<b>Code</b>	<b>KAC21</b>	<b>KAC22</b>	<b>KROSSPACK™ 20V Lithium Ion Batteries</b>							
Rated Voltage	20V Max	20V Max								
Power Input	160W	260W	<b>Code</b>	<b>KAB21</b>	<b>KAB24</b>	<b>KAB25</b>				
Charging Current	6A Max	12A Max	Battery Voltage	20V	20V	20V				
Charging Times	<ul style="list-style-type: none"> <li>• 2.0Ah ±22mins</li> <li>• 4.0Ah ±45mins</li> <li>• 6.0Ah ±65mins</li> <li>• 8.0Ah ±100mins</li> </ul>	<ul style="list-style-type: none"> <li>• 4.0Ah ±25mins</li> <li>• 6.0Ah ±35mins</li> <li>• 8.0Ah ±60mins</li> </ul>	Battery Capacity	4.0Ah	6.0Ah	8.0Ah				

TEST INSTRUMENTS, TOOLS & GENSETS

**NEW**



**CORDED POWER TOOLS**

**Angle Grinders**

2 Year Standard Warranty			Brushless		
Extendable for 1 Additional Year by Online Warranty					
<b>Code</b>	<b>KUS04P</b>	<b>KUS05P</b>	<b>KUS26</b>	<b>KUS35P</b>	
Rated Power	830W	900W	1200W	2200W	
No Load Speed	0-12000rpm	0-11000rpm	0-11000rpm	0-6500rpm	
Disc Diameter	115mm	115mm	125mm	230mm	
Bore Diameter	22.2mm	22.2mm	22.2mm	22.2mm	
Adjustable Handle	2-Position	2-Position	2-Position	3-Position	
Adjustable Guard	Yes	Yes	Yes	Yes	
Accessories Incl.	<ul style="list-style-type: none"> <li>• Spanner</li> <li>• Auxillary Handle</li> <li>• Grinding Wheel Guard</li> </ul>	<ul style="list-style-type: none"> <li>• Spanner</li> <li>• Auxillary Handle</li> <li>• Grinding Wheel Guard</li> </ul>	<ul style="list-style-type: none"> <li>• Spanner</li> <li>• Auxillary Handle</li> <li>• Grinding Wheel Guard</li> <li>• U-type dust cover</li> </ul>	<ul style="list-style-type: none"> <li>• Spanner</li> <li>• Auxillary Handle</li> <li>• Grinding Wheel Guard</li> </ul>	
Features	<ul style="list-style-type: none"> <li>• Soft start &amp; anti-restart protection provide a safer working environment</li> <li>• Auto stop carbon brushes stop the motor when the brushes require replacement</li> <li>• Detachable grating which prevents damage from debris, prolongs the motor life</li> <li>• The spindle lock button allows easy disc change</li> </ul>	<ul style="list-style-type: none"> <li>• Soft start &amp; anti-restart protection provide a safer working environment</li> <li>• Auto stop carbon brushes stop the motor when the brushes require replacement</li> <li>• Detachable grating which prevents damage from debris, prolongs the motor life</li> <li>• The spindle lock button allows easy disc change</li> </ul>	<ul style="list-style-type: none"> <li>• AC Brushless tech brings superior overload protection, allows continous working under harsh conditions, higher efficiency &amp; 2x longer lifetime</li> <li>• No efficiency reduction under heavy-duty cutting &amp; grinding with intelligent chip control system</li> <li>• Automatically adapt to voltage fluctuations(170V-260V)</li> <li>• Soft start &amp; anti-restart protection</li> <li>• Quick guard adjustment</li> </ul>	<ul style="list-style-type: none"> <li>• Max output power of 3000W, with strong anti-overload ability</li> <li>• Air vent design for better ventilation &amp; heat dissipation</li> <li>• Soft start and anti-restart protection provide a safer working environment</li> <li>• The spindle lock button allows easy disc change</li> </ul>	

**Hand Drills**

**Oscillating / Multi Tools**

2 Year Standard Warranty				
Extendable for 1 Additional Year by Online Warranty				
<b>Code</b>	<b>KU110K</b>	<b>KU120</b>	<b>Code</b>	<b>KUW58.1</b>
Rated Power	500W	650W	Rated Power	480W
No Load Speed	0-2800rpm	0-3000rpm	No Load Speed	11000-20000/min
Chuck	10mm Keyless	13mm Keyed	Oscillation Angle	5°
Max. Drill Capacity	Wood 20mm, Steel 10mm, Aluminium 10mm	Wood 30mm, Steel 13mm, Aluminium 13mm	Accessories Incl.	<ul style="list-style-type: none"> <li>• 35mm End Cut Blade</li> <li>• 35mm Precision Blade</li> <li>• 35mm bimetal blade</li> <li>• 80mm HSS semi circle saw blade</li> <li>• Sanding pad</li> <li>• 6 x Sand paper</li> <li>• Rigid Scraping Blade</li> <li>• Stacking Case(M)</li> </ul>
Variable Speed	Yes	Yes	Features	<ul style="list-style-type: none"> <li>• Vibrafree® features 3X Cutting efficiency with reduced vibration.</li> <li>• Microsonic high frequency oscillation technology</li> <li>• Ideal for wood, metal, plastic tile, drywall &amp; more</li> <li>• Universal Interface compatible with majority of other brand accessories</li> <li>• The variable speed control &amp; multi-angle adjustment adapts to different applications for cutting, sawing, scraping, sanding, polishing, removing &amp; more</li> <li>• Hyperlock™ tool free system provides 1 ton clamping force preventing blade slippage</li> </ul>
Forward & Reverse	Yes	Yes		
Accessories Incl.	-	Chuck Key		
Features	<ul style="list-style-type: none"> <li>• High power &amp; high torque</li> <li>• Precision high quality cast steel parts to deliver more stable performance</li> <li>• Compact body design &amp; comfortable to use</li> <li>• Forward &amp; reverse rotation control</li> </ul>	<ul style="list-style-type: none"> <li>• High power &amp; high torque</li> <li>• Precision cast steel as high quality parts to deliver more stable performance</li> <li>• Compact body design &amp; comfortable to use</li> <li>• Forward &amp; reverse rotation control</li> </ul>		



**NEW**

**CORDED POWER TOOLS**

	Rotary Hammer Drill	Rotary Hammer	Rotary Hammer	Demolition Hammer
2 Year Standard Warranty				
Extendable for 1 Additional Year by Online Warranty				
<b>Code</b>	<b>KUX12P</b>	<b>KUX15P</b>	<b>KUX21</b>	<b>KUX35P</b>
Rated Power	850W	1100W	1050W	1200W
No Load Speed	0-1300rpm	0-900rpm	0-610rpm	-
Chuck	SDS+	SDS+	SDS Max	SDS Max
Impact Energy	3J	5J	7.5J	14J
Impact Rate	0-5500bpm	0-4300 bpm	0-4150 bpm	0-3500 bpm
Max. Drill Capacity	Masonry 26mm, Wood 30mm, Steel 13mm	Concrete 28mm	Concrete 38mm	-
Variable Speed	Yes	No	No	No
Forward & Reverse	Yes	No	No	No
Accessories Included	<ul style="list-style-type: none"> <li>• Auxillary Handle</li> <li>• Depth Gauge</li> <li>• Carry Case</li> </ul>	<ul style="list-style-type: none"> <li>• Auxillary Handle</li> <li>• Spanner</li> <li>• Carry Case</li> </ul>	<ul style="list-style-type: none"> <li>• Auxillary Handle</li> <li>• Depth Gauge</li> <li>• Carry Case</li> </ul>	<ul style="list-style-type: none"> <li>• Auxillary Handle</li> <li>• Spanner</li> <li>• Bull Point Chisel</li> <li>• Carry Case</li> </ul>
Features	<ul style="list-style-type: none"> <li>• 850W motor with SDS+ for delivering drilling diameters up to 26mm</li> <li>• Powerful 3J of impact energy</li> <li>• 3 function: drilling, hammer drilling &amp; chiseling, with a separate chisel angle adjustment feature</li> <li>• Variable speed trigger for greater control when drilling</li> </ul>	<ul style="list-style-type: none"> <li>• 2 Function: Hammer drilling &amp; chiseling</li> <li>• Patented flexible floating chuck offers dust protection and less oil leakage for an increased lifetime</li> <li>• Rotation control clutch, improves safety &amp; reduces the risk of over load damage</li> <li>• Variable speed trigger for greater control when drilling</li> <li>• Anti-vibration technology combined with an ergonomic design for improved comfort &amp; control</li> </ul>	<ul style="list-style-type: none"> <li>• Anti-vibration technology combined with an ergonomic design for improved comfort &amp; control</li> </ul>	<ul style="list-style-type: none"> <li>• Robust metal housing for increased strength, resistance &amp; lifetime</li> <li>• Anti-vibration technology combined with an ergonomic design for improved comfort &amp; control</li> <li>• Dust-proof cover in front of chuck can protect the tool from dust &amp; splash</li> <li>• Easy-to-operate lock-on power mode with self-locking button</li> </ul>

**ABOUT KRESS**

Kress was founded in Germany in 1928. With more than 90 years of experience in electric motors, R&D and production and more than 50 years of experience in the creation and production of power tools, several generations of professional users have trusted Kress and its power tools for quality, reliability and durability.

**WHY KRESS?**

KRESS is the benchmark brand of power tools for professionals. The entire range of products is endowed with high quality and powerful innovative technology, earning the reputation of end users all over the world.

Kress is positioned as a professional market leader in the global market thanks to its continuous improvements to better serve the wishes of customers, offering them efficient and top quality solutions in the power tools industry.

**KRESS WARRANTY**

A 3 year warranty period applies to all AC (electrical) and DC 20V Max (cordless) products from the date of purchase, except for accessories and consumables. We offer to extend the warranty period for Kress DC 20V Max tools by 3 (three) years to a total of 6 (six) years from the date of purchase of the product.



## CORE DRILLING MACHINE

Core Drilling Machines c/w Stand		Core Drill Bits		Water Swivel Adaptor	
<b>Code</b>	<b>R1011</b>	<b>R1721</b>	<b>RC35-*</b>	<b>RC70-*</b>	<b>WATER SWIVELS</b>
Supply	220-240VAC	220-240VAC	1/2" Box Thread	1 1/4" UNC Thread	Fits a standard 1/2" chuck Allows wet core drilling using <b>RC35</b> core bit Capacity: 12 - 77mm Diameter No hammer action required
Watts	1100W	1700W	* Add size to code: 20mm (ID: 15mm L: 400mm)	* Add size to code: 52mm (ID: 44mm L: 450mm)	
Shaft Speed	970rpm	450/900rpm	25mm (ID: 20mm L: 400mm)	67mm (ID: 59mm L: 450mm)	
Core Bit Type	<b>RC35</b>	<b>RC70</b>	32mm (ID: 27mm L: 400mm)	109mm (ID: 101mm L: 450mm)	
Bit Sizes	60-120mm	40-300mm	52mm (ID: 46mm L: 400mm)	117mm (ID: 109mm L: 450mm)	
Output Shaft Thread	1/2" Box	1 1/4 UNC	Suitable for wet drilling of reinforced concrete/masonry		
Weight	6.1kg	18.2kg			

## POWER TOOLS

Electric Blower		Cordless Screwdrivers											
	<table border="1"> <tr> <td><b>Code</b></td> <td><b>EB-J30A</b></td> </tr> <tr> <td>Supply</td> <td>220-250V 50Hz</td> </tr> <tr> <td>Rated Input</td> <td>550W</td> </tr> <tr> <td>Air Volume</td> <td>2.8m³/h</td> </tr> <tr> <td>Speed</td> <td>500-1500r/min</td> </tr> </table>	<b>Code</b>	<b>EB-J30A</b>	Supply	220-250V 50Hz	Rated Input	550W	Air Volume	2.8m³/h	Speed	500-1500r/min		
<b>Code</b>	<b>EB-J30A</b>												
Supply	220-250V 50Hz												
Rated Input	550W												
Air Volume	2.8m³/h												
Speed	500-1500r/min												
		<b>Code</b>	<b>SND113</b>	<b>SND114</b>									
		Volts	6V	3.6V									
		Speed	180rpm	150rpm									
		Spare Battery	<b>SND6V</b>	<b>SND3.6V</b>									

### Heat Guns

Heat Guns			Glue Gun
<b>Code</b>	<b>PLD2230</b>	<b>PLD2232</b>	<b>ZD-7</b>
Power	2000W	2000W	40Watt Glue Gun
Features	3 Speed / Temperature Settings: 1: 50°C / 500/min 2: 450°C / 250/min 3: 600°C / 500/min	3 Speed / Temperature Settings 1: 50°C / 250/min 2: 50-600°C (Adj.) / 250/min 3: 50-600°C (Adj.) / 500/min Able to work continuously without overheating.	Hot Airgun Low/Off/High 200°C – Off – 500°C
			<b>ZD-7GLUE</b>
			<b>ZD-7GLUE-300</b>

### 12VDC Wrench & Jack Auto Kit for every car owner

12VDC Wrench & Jack Auto Kit	
<b>Code</b>	<b>HF-12</b>
<b>Impact Wrench</b>	<b>Electric Jack</b>
• Voltage: 12VDC	• Voltage: 12VDC
• Working Current: ≤8A	• Max Load: 950kg
• Max Torque: 300 NM	• Working Current: ≤10A
• Output Shaft: 1/2"m (13mm)	• Lifting Height: 22cm (12-34cm)

## CORDLESS POWER TOOLS - LI-ION

	20V Cordless Drill	20V Cordless Hammer Drill	20V Cordless Impact Driver	20V Cordless Impact Wrench	20V Cordless Rotary Hammer
All supplied c/w 2.0Ah Li-ion Battery & Fast Charger LED Work Light					
<b>Code</b>	<b>LCD777-1S</b>	<b>LCD777-1SC</b>	<b>LCW777-1A</b>	<b>LCW777-1B</b>	<b>LCH777-1</b>
No Load Speed	0-400 / 0-1400RPM	0-440 / 0-1650RPM	0-2800RPM	0-2800RPM	0-900RPM
Max Torque	35Nm	50Nm	180Nm	250Nm	—
Torque Settings	25 + 1(Drill)	20 + 1(Drill) + 1(Hammer)	—	—	—
Chuck	2-13mm	2-13mm	1/4" Hex	1/2" Square	SDS Plus
Impact Rate	—	0-7920 / 0-24700BPM	0-3600BPM	0-3600BPM	0-5000BPM
Features	<ul style="list-style-type: none"> <li>• 2 Speed</li> <li>• Forward / Reverse</li> <li>• Magnetic Bit Holder</li> <li>• Spare Battery: <b>LY777/2.0AH</b></li> </ul>	<ul style="list-style-type: none"> <li>• 2 Speed</li> <li>• Forward / Reverse</li> <li>• Magnetic Bit Holder</li> <li>• Side Handle</li> <li>• Spare Battery: <b>LY777/2.0AH</b></li> </ul>	<ul style="list-style-type: none"> <li>• Durable Gearbox</li> <li>• Forward / Reverse</li> <li>• Magnetic Bit Holder</li> <li>• Spare Battery: <b>LY777/2.0AH</b></li> </ul>	<ul style="list-style-type: none"> <li>• Durable Gearbox</li> <li>• Forward / Reverse</li> <li>• Spare Battery: <b>LY777/2.0AH</b></li> </ul>	<ul style="list-style-type: none"> <li>• Impact Force: 1.1J</li> <li>• 2 Function Rotary Selector (Drill/Hammer)</li> <li>• Forward / Reverse</li> <li>• Spare Battery: <b>LY777/2.0AH</b></li> </ul>
	<b>20V Cordless Circular Saw</b>	<b>20V Cordless Angle Grinder</b>	<b>20V (Li-ion) Battery</b>		<b>3.6V Cordless Screwdriver</b>
All supplied c/w 2.0Ah Li-ion Battery & Fast Charger				Supplied c/w Li-ion Battery & Charger	
			<b>LY777/2.0AH</b> <b>LY777/4.0AH</b>		
<b>Code</b>	<b>LCC777-1</b>	<b>LCG777-1</b>	c/w LED Charge State Indicator	<b>Code</b>	<b>LY529</b>
No Load Speed	4200RPM	10000RPM		No Load Speed	180rpm
Blade Size	Ø165mm	Disc Dia: 115/125mm		Max Torque	4Nm
Bore	Ø20mm	Ø22mm		Torque settings	10+1(Drill)
Cutting Capacity	48mm@90° / 36mm@45°	-	<b>20V Fast Charger</b>	Chuck	1/4" Hex
Features	<ul style="list-style-type: none"> <li>• AI Guard and Sole Plate</li> <li>• Laser Guide</li> <li>• Dust Extaction Port</li> <li>• Spare Battery: <b>LY777/2.0AH</b></li> </ul>	<ul style="list-style-type: none"> <li>• Spindle Lock</li> <li>• Quick Change Guard</li> <li>• 3-Position Handle Fixing</li> <li>• Spare Battery: <b>LY777/4.0AH</b></li> </ul>		Battery	Built-in
			<b>LYKC777</b> Charging Current: 2.3A	Features	<ul style="list-style-type: none"> <li>• Supplied in case with 55pc bit set.</li> <li>• 60° Swivel Handle for ease of use</li> <li>• LED Work Light</li> <li>• LED Batt. Indicator</li> </ul>
					<ul style="list-style-type: none"> <li>• 2 Speed</li> <li>• Forward / Reverse</li> <li>• LED Work Light</li> <li>• Magnetic Bit holder</li> <li>• Spare Battery: <b>LY666/2.0AH</b></li> </ul>

## CORDLESS POWER TOOLS

	Reciprocating Saw	Jig Saw	Delta Sander
			
<b>Code</b>	<b>WLP827-01</b>	<b>WLP821-01</b>	<b>WLP825-01</b>
Power	18V Ni-cd Battery	18V Ni-cd Battery	18V Ni-cd Battery
No Load Speed	2800rpm	1700rpm	6000rpm
Cutting Capacity	Maximum Cutting Depth: 101mm Stroke length: 22mm	Wood: 50mm, Mild Steel: 3mm Bevel angle range: 0-45°	Sanding Pad: 90 x 90 x 90mm
Spares	Wood blade: <b>WL-RS01W/5</b> Metal blade: <b>WL-RS02M/5</b> Battery: <b>WL-BA01</b> Charger: <b>WL-CH01</b>	Wood blade: <b>WL-JS01W/5</b> Metal blade: <b>WL-JS02M/5</b> Battery: <b>WL-BA02</b> Charger: <b>WL-CH02</b>	Spare Delta Sanding Paper: <b>WL-DS01/10</b> Battery: <b>WL-BA02</b> Charger: <b>WL-CH02</b>

WHILE STOCKS LAST



## PROFESSIONAL POWER TOOLS

	Angle Grinder		Impact Drill	
<b>Code</b>	<b>MCOP1627</b>	<b>MCOP1593</b>	<b>MCOP1573</b>	<b>MCOP1592</b>
Power	2200W	850W	500W	900W
No Load Speed	-	-	Variable Speed	Variable Speed
Chuck Size	-	-	Ø13mm	Ø13mm
Disc Diameter	Ø230mm	Ø115/125mm	-	-
Spindle Size	Ø22mm	Ø22mm	-	-
Weight	6.9kg	2.7kg	2.3kg	2.9kg

### Drill/Grinder Combo



Code	MCOP1584	
Type	Drill	Grinder
Power	500W	650W
No Load Speed	Variable Speed	Variable Speed
Chuck Size	Ø13mm	-
Disc Diameter	-	Ø115mm
Size (mm)	265 x 300 x 75	120 x 300 x 140
Weight	2.3kg	3.4kg

## WELDING MACHINES

 Insulation Class H IP21	Heavy Duty	Inverter	DIY Inverter
	TORNADO 200	MIG ONE	HOBBY WELD
<b>Code</b>	<b>WM-42305</b>	<b>WM-11000</b>	<b>MCOW4054</b>
Voltage	1PH 230/400V	1Ph/230V	1Ph/230V
Absorbed Power	4.4KVA	1.2KVA	-
Welding Current	50-180A	33-95A	140A
Electrode Ø	1.6-4mm	0.8-1mm	1.6-3.2mm

All Awelco welding machines supplied with electrode holder and earth clamp.

### Inverter Welders

MMA: c/w Cable Sets ready to use INMIG: c/w Earth Cable & MIG torch Supply Voltage: 230VAC			
	<b>MCOw4095</b>	<b>S-MMA-210</b>	<b>S-INMIG-205</b>
Type	MMA	MMA	MIG / MMA
Rated Input Capacity	7.04KW	7.1KW	6.4KW
Current Adjustment	20-200A	10-200A	20-200A
Output Voltage	57V	78V	57V
Rated Duty Cycle	60% @ 200A	60% @ 200A	60% @ 180A
Electrode Diameter	1.6-4MM	1.6-4.0MM	1.6-4.0MM
Features	IGB Inverter Technology Anti Sticking	IGB Inverter Technology Anti Sticking	Auto Wire Feed

## WELDING ACCESSORIES

Welding Helmet Lenses 108 x 51mm		Brush Wire		Electrode Holder	
<b>Code</b>	<b>TOOW4242G</b>	<b>TOOW4242H</b>	<b>TOOB38</b>	<b>EWC0074</b>	<b>TOOW4240</b>
<b>Description</b>	Shaded Glass	Clear Glass	5 Rows	Collet Type, 600A	KD Type, 500A
<b>Earth Clamp</b>		<b>Chipping Hammer</b>		<b>Bench Vice Swivel Heavy Duty</b>	
<b>Code</b>	<b>TOOW4238</b>	<b>JW-AC012</b>	<b>YT-6501</b>	<b>YT-6503</b>	<b>C061SK</b>
<b>Description</b>	300A	500g	100mm	150mm	600mm
<b>G Clamps</b>		<b>Welding Clamp Magnets</b>		<b>General Purpose Welding Rods</b>	
				General Prepack: E6013 	
<b>Code</b>	<b>C075GK</b> 75mm	<b>TOOW4235</b> Small	<b>ELE001</b> 12pcs, 2.0mm	<b>6 Pcs Welding Kit</b>	
	<b>C150GK</b> 150mm	<b>TOOW4234</b> Medium	<b>ELE002</b> 10pcs, 2.5mm		
	<b>C200GK</b> 200mm	<b>TOOW4233</b> Large	<b>ELE003</b> 8pcs, 3.2mm	<b>Welding Cable Set</b>	
<b>Welding Helmets</b>		<b>Wire Cup Brushes</b>		<b>Bulk Mild Steel Electrodes</b>	
<b>JW-SFTB-002</b> <b>JW-SFTB-005</b>		<b>Code</b> <b>JW-SFTB-002</b> <b>JW-SFTB-005</b> Sensitivity Control      Low / High      Auto Power Supply      2 x AAA Battery      Solar- No Battery Switching Time      1 / 15 000s      1 / 15 000s • Light State: DIN4 • Shade Control: External, Variable • Dark State: Variable Shade 9-13 • Grinding Function		<b>TOOW4237A</b> • Flip front face shield • 2.5 x 16mm Green welding cable with earth clamp • 2.5 x 16mm Green welding cable with electrode holder • 5 Row wire brush • Metal Chipping Hammer • Pair of welding gloves	
				<b>EWCAB1070</b> • 1x 300A Electrode Holder • 1x 300A Earth Clamp • 2x 10-25 Dinse Connectors (Jack Plugs) • 2x 1.5m x 25mm <sup>2</sup> Blue Welding Cables	
				<b>Code</b> <b>WB-R-65</b> <b>WB-R-75</b> <b>WB-R-100</b> <b>JW-E1025</b> <b>JW-E1032</b> Description      Ø65 x M14      Ø75 x M14      Ø100 x M14      Mild Steel Electrodes 5kg / 2.5mm      Mild Steel Electrodes 1kg / 3.2mm	

## SAFETY ACCESSORIES

	<b>Heavy Duty Winter Grip - Latex Palm</b>	<b>Cut Resistant - Latex Palm</b>	<b>Light Duty - Latex Palm</b>	<b>Red PVC / Knit-Wrist</b>	<b>Candy Strip Rigger</b>																									
	 Size: 9 EN388: 4231	 Size: 9 EN388: 3544	 Size: 10 EN388: 3111	 Size: 9 EN388: 4121	 Size: 9																									
<b>Code</b>	<b>G074-9</b>	<b>G060-9</b>	<b>G057-10</b>	<b>G013-9</b>	<b>G010-9</b>																									
	<b>Green Lined Welding - Wrist</b>	<b>Green Lined Welding - Elbow</b>	<b>Chrome Leather Short</b>	<b>8" Chrome Leather</b>	<b>8" Red Heat Resistant</b>	<b>Mig Welding Glove</b>																								
	 Size: 10	 *Size: 9 or 10	 Size: 10	 *Size: 9 or 10	 *Size: 9 or 10	 *Size: 9 or 10																								
<b>Code</b>	<b>G023-10</b>	<b>G022-*</b>	<b>G001-10</b>	<b>G004-*</b>	<b>G1028-*</b>	<b>G012-*</b>																								
	<b>Green Nitrile Gloves</b>	<b>Black Rubber Builders Gloves</b>	<b>Red PVC open Cuff</b>	<b>8" Red Heat Resistant</b>	<b>Exam Gloves</b>																									
	 Size: 10	 Size: 10	 Size: 10	 *Size: M-L-XL Pack of 100/200	 *Size: S-M-L-XL Pack of 100																									
<b>Code</b>	<b>G033-10</b>	<b>G018-10</b>	<b>G016-10</b>	<b>LATEX GLOVES</b>	<b>EXAM GLOVES</b>																									
	<b>Dust Mask</b>	<b>Safety Spectacles</b>	<b>Safety Spectacles</b>	<b>Safety Glasses with Side Shield</b>																										
		 Black Frame	 Sporty Look	 Clear	 Amber																									
<b>Code</b>	<b>FFP2-1</b>	<b>EURO1</b>	<b>EURO2</b>	<b>JW-SFT028</b>	<b>JW-SFT030</b>	<b>SB216040</b>																								
	<b>Protection Goggles</b>	<b>Safe Face Shield</b>	<b>Chrome Leather Apron</b>	<b>Ear Muffs</b>	<b>Ear Plugs Disposable</b>	<b>Hard Hat</b>																								
																														
<b>Code</b>	<b>FACE SHIELD</b>	<b>TOOG774</b>	<b>LA-90</b>	<b>TOOE502</b>	<b>TOOE505</b>	<b>G002</b> White <b>G003</b> Blue																								
	<b>Conti Suits</b>				<b>Dust Coat</b>	<b>Size Chart (mm)</b>																								
	Acid/Flame Resistant c/w Reflective Tapes 					<table border="1" style="width: 100%; border-collapse: collapse;"><thead><tr><th>Size</th><th>Chest</th><th>Waist</th></tr></thead><tbody><tr><td>S</td><td>82-87</td><td>72-77</td></tr><tr><td>M</td><td>92-97</td><td>82-87</td></tr><tr><td>L</td><td>102-107</td><td>92-97</td></tr><tr><td>XL</td><td>112-117</td><td>102-107</td></tr><tr><td>2XL</td><td>122-127</td><td>112-117</td></tr><tr><td>3XL</td><td>132-137</td><td>122-127</td></tr><tr><td>4XL</td><td>142-147</td><td>132-137</td></tr></tbody></table>	Size	Chest	Waist	S	82-87	72-77	M	92-97	82-87	L	102-107	92-97	XL	112-117	102-107	2XL	122-127	112-117	3XL	132-137	122-127	4XL	142-147	132-137
Size	Chest	Waist																												
S	82-87	72-77																												
M	92-97	82-87																												
L	102-107	92-97																												
XL	112-117	102-107																												
2XL	122-127	112-117																												
3XL	132-137	122-127																												
4XL	142-147	132-137																												
<b>Code</b>	<b>AF-CG34-*</b>	<b>J54001N-*</b>	<b>RB001-*</b>	<b>GM002-*</b>	<b>DC003-*</b>																									
<b>Code</b>	Green (Sizes as per Chart) <b>AF-CNB34-*</b>	Navy Blue 100% Cotton	Royal Blue	Navy Blue Denim Material	Royal Blue																									
	Navy Blue (Sizes as per Chart)	*Add Size to size to code: <b>S</b> (Small), <b>M</b> (Medium), <b>L</b> (Large), <b>XL</b> (Xtralarge) <b>2XL</b> (XXtralarge), <b>3XL</b> (XXXlarge), <b>4XL</b> (XXXXLarge)																												



## SAFETY ACCESSORIES



**P3**

### 3M Comfort Grip Gloves

Perfect for light to medium duty jobs that require precision handling, even in hot and sweaty conditions.

Code	Includes
WX300921193	Large
WX300921201	Xtra-Large

#### Characteristics:

- Exceptional comfort and breathability: Thin foam coating provides high breathability for maximum comfort.
- Fine gauge knit nylon liner provides flexibility and padding
- High Durability: Unique nitrile formula offers resistance to abrasion.
- Machine washable

#### Benefits:

- Sweat Protection
- Maximized Tactile Sensitivity
- Excellent Dexterity
- Oil Resistant

## PRESSURE WASHERS



Code	MCOP1507	MCOP1508	MCOP1510
Power Rating	1350W	1850W	2200W
Rated Pressure	65Bar	95Bar	110Bar
Rated Flow	360L/H	360L/H	360L/H
Nett Weight	6kg	9kg	14kg
Supplied with	Variable Nozzle, 3m Hose, Detergent Bottle, Coupler/Connector	Variable Nozzle, 5m Hose, Detergent Bottle, Coupler/Connector	Variable Nozzle, 7m Hose, Detergent Bottle, Coupler/Connector

## COMPRESSORS

### Direct Drive



### Belt Drive



### Oil Free



Code	MCFRC100	MCFRC102A	MCFRC221	MCFRC228	MCFRC241	MCFRC243
Compressor Type	Direct Drive	Direct Drive	Belt Drive	Belt Drive	Direct Drive/Oil Free	Direct Drive/Oil Free
Tank Capacity	24L	50L	100L	150L	24L	50L
Motor Size	1.1KW / 1.5HP	1.5KW / 2HP	1.5KW / 2HP	2.2KW / 3HP	0.55KW	2 x 0.75KW
Input Power	230V/50Hz	230V/50Hz	230V/50Hz	230V/50Hz	230V/50Hz	230V/50Hz
Max Pressure	800Kpa (8 Bar)	800Kpa (8 Bar)	800Kpa (8 Bar)	800Kpa (8 Bar)	700Kpa (7 Bar)	700Kpa (7 Bar)
Free Air Delivery	@700Kpa:65l/m	@700Kpa:105l/m	@700Kpa:130l/m	@700Kpa:250l/m	@600Kpa:50l/m	@600Kpa:150l/m
Piston Displacement	138l/Min	206l/Min	165l/Min	370l/Min	206l/Min	2 x 138l/Min



#### Tradeair Compressor Oil

Code	T0001286
Capacity	1 Litre

Used for the following applications:

- Tyre Centers
- Supermarkets
- Car Washes
- Bakers
- Petrol Stations
- Laboratories
- Garages

Used by the following Professionals:

- Dentists
- Mechanics
- Spray Painters
- Also useful for any Small Business or DIY enthusiasts

## AIR ACCESSORIES

	Air Duster	Wash Gun	Sand Blasting Gun	Air Brush Set	Tyre Inflator Gun Pro/Kit	
<b>Code</b>	<b>TOOS1751</b>	<b>PAB1211</b>	<b>PAB1210</b>	<b>PAB1209*</b>	<b>PAB1204</b>	
Compressor Pressure	1.1KW 3-8 Bar	1.1KW 4-7 Bar	2.2KW/3HP 6 Bar	Set consists of: 22cc Cup, Hand piece protective cap, 5cc Metal cap, 60cc Mixing jar with lid, Spray jar, PVC Airline hose with adapters, Spanner.	1.1KW 3-8 Bar	
Application	Blowing & Cleaning	Cleaning: Car Bodywork, Parts, Drains & Patios	Removes All Paints & Rust spots, Prep for Painting		Inflate: Car Tyres, Bicycle Tyres, Air Beds, Footballs etc.	
	<b>Gravity Feed Spray Gun</b>	<b>Suction Feed HP Spray Gun</b>	<b>Delux Mini HVLP Spray Gun</b>	<b>PVC Airline Hose</b>	<b>PVC High Pressure Hose</b>	
	 Spare Cup TOOS1792					
<b>Code</b>	<b>TOOS1789</b>	<b>TOOS1785</b>	<b>TOOS1790</b>	<b>TOOH910</b>	<b>TOOH501</b>	<b>TOOH506</b>
Compressor Pressure	1.5KW or above 3.5 - 4.8 Bar	1.5KW -2HP 3.5 - 4.8 Bar	1.5KW or above 2 - 5.5 Bar	10m Length Ø6mm	20m Length Ø6mm	100m Length Ø6mm
Cup Capacity	600ml	1000ml	100ml	10m Length Supplied Fitted with:		
Air Consump.	228L/Min	280L/Min	160-300L/Min	<b>TOOC349</b>		
Fluid Nozzle	Ø1.4mm	Ø2.0mm	Ø1.4mm	Air Connectors Both Ends		
Features	Paint Flow, Fan Adj, Air Control.	For professional quality	Non-Bleeder Type	<ul style="list-style-type: none"> <li>• Ideal for pressure lines &amp; Compressors</li> <li>• 1750kPA</li> <li>• Air/Water hose</li> <li>• Weather &amp; Abrasion resistant</li> </ul>		

\* Suitable for: Hobby enthusiasts & model makers: Spraying with Cellulose & Enamel

## AIR CONNECTORS







<b>Code</b>	<b>TOOC340</b>	<b>TOOC341</b>	<b>TOOC342</b>	<b>TOOC344</b>
Connect 1	Quick Connect Female	Quick Connect Male	Quick Connect Male	Air Hose Fitting - 8mm
Connect 2	BSP1/4" Female	BSP1/4" Male	BSP1/4" Female	Quick Connect Male
			<b>Inline Lubricator</b> 	<b>Coupler 5Pcs Air Hose Connector</b> 
<b>Code</b>	<b>TOOC346</b>	<b>TOOC349</b>	<b>PAB1222</b>	<b>TOOC348</b>
Connect 1	Air Hose Fitting	Air Hose Fitting - 6mm	Helps to reduce wear on air tools. Automatically lubricates air line system.	Kit Includes: • TOOC346 • TOOC342 • TOOC340 • TOOC344 • TOOC341
Connect 2	BSP1/4" Male	Spray Gun Fitting		

## TOOL BAGS





	Professional Trolley Tool Bag	Tool Bag with Tubular Handle	Super Open Mouth Tool Bag
	42 Pockets  <b>WITH WHEELS</b>	56 Pockets 	24 Pockets 
<b>Code</b>	<b>SB-L001</b>	<b>SB-T017</b>	<b>SB-S002</b>
<b>Fabric</b>	Polyester 600D	Polyester 600D	Polyester 600D & 1680D
<b>Pockets</b>	10-Exterior, 32-Interior	14-Exterior, 42-Interior	15-Exterior, 9-Interior
<b>Bag Size</b>	360 x 250 x 430mm	490 x 280 x 370mm	420 x 300 x 250mm
<b>Capacity</b>	25kg	25kg	25kg
<b>Features</b>	Three-Step Heavy Duty Trolley with stop	Foldable Sides	Wide Opening
	Popular Lady's Tool Bag	Roller/Back-Pack Tool Bag	Back-Pack
	15 Pockets 	9 Pockets  <b>WITH WHEELS</b>	20 Pockets 
<b>Code</b>	<b>SB-S005</b>	<b>SB-P001</b>	<b>SB-P003</b>
<b>Fabric</b>	Polyester 600D	Polyester 600D	Polyester 600D
<b>Pockets</b>	12-Exterior, 3-interior	4-Exterior, 5-Interior	5-Exterior, 15-Interior
<b>Bag Size</b>	300 x 170 x 220mm	360 x 250 x 540mm	370 x 160 x 460mm
<b>Capacity</b>	15kg	20kg	20kg
<b>Features</b>	-	Roller or Back-Pack on Wheels	c/w Rubber Bottom
	Multi Purpose Bag	Tool Bag with Seat	Handy Tool Bag
	12 Pockets 	6 Pockets 	13 Pockets Tool-Bag with Shoulder Strap 
<b>Code</b>	<b>SB-B023</b>	<b>SB-M005</b>	<b>SB-C003</b>
<b>Fabric</b>	Polyester 600D	Polyester 600D	Polyester 600D
<b>Pockets</b>	8-Exterior, 4-interior	6-Exterior	12-Exterior, 3-Interior
<b>Bag Size</b>	330 x 570mm	420 x 290 x 310mm	240 x 240 x 420mm
<b>Capacity</b>	8kg	80kg	15kg
	Utility Vest Kit	Hands-free Vest	Belt Tool Pouch
	14 Pockets 	• Adjustable - 1 size fits all • Heavy Duty material & 3 Zippers 	• Universal 
<b>Code</b>	<b>SB-G005</b>	<b>SB210404</b>	<b>EUROMARIO</b>
<b>Fabric</b>	Polyester 600D	Polyester 600D	Industrial Nylon
<b>Pockets</b>	14-In total	7 Pockets	3-Exterior, 2-Interior
<b>Bag Size</b>	650 x 500mm	500 x 595mm	Belt Mount
<b>Capacity</b>	-	-	-



## METAL TOOL CASES

Aluminium Tool Boxes	Steel Canterlever	Steel Tool Box	Steel 3-in-1 Combo	Plastic Trolley Case
 <b>MJ-3083</b> 520L x 210H x 230W	 <b>MJ-20565</b> 565L x 215H x 220W	 <b>SB210211</b> • 4 Drawers and top compartment Toolbox • On wheels • Lockable • 668L x 386H x 316W	 <b>JF-A300ABC</b> 581 x 297 x 266H 495 x 285 x 222H 460 x 204 x 181H	 <b>MJ-2055</b> 712H x 315D x 485W
 <b>MJ-3085</b> 594L x 210H x 230W				

### Plastic Tool Boxes

 <b>MJ-30019D</b> 485L x 270H x 245W	 <b>MJ-10571</b> 420L x 230H x 200W	 <b>MJ-10555A</b> 395L x 235H x 175W	 <b>MJ-12056</b> 500L x 240H x 260W
---	--	---	--

### Tool Cabinets • 1st drawer includes division boxes, other 3 drawers include dividers

 Division Boxes  Dividers	 <b>ELS-274M</b> 863H x 1070W x 515D 4 x 150H Blue	 <b>ELS-274MA</b> 1333H x 1070W x 515D 4 x 150H Blue	 <b>ELS-276M</b> 863H x 1070W x 515D 2 x 75H; 2 x 100H; 1 x 150H Blue	 <b>ELS-276MA</b> 1333H x 1070W x 515D 2 x 75H; 2 x 100H; 1 x 150H Blue
--	---	---	---	--

### Mobile Tool Cabinets • 1st drawer includes 12 division boxes, other drawers have 3 compartments each

 <b>ELA-185M</b> 1000H x 500W x 630D 1 x 100H; 4 x 150H Red	 12 Free hanger hooks incl. <b>ELA-185MA</b> 1480H x 500W x 630D 1 x 100H; 4 x 150H Red	 <b>HL3103-A</b> 950H x 960W x 570D 3 x 65H; 1 x 145H; 1 x 225H Stainless Steel
--	---	--

## PLASTIC TOOL BOX ORGANISERS

2 Door Storage Boxes		Storage Box	Storage Drawers	
<b>ZD-B2</b>	<b>MJ-10237</b>	<b>MJ-46368</b>	<b>MJ-10184</b>	<b>MJ-10219</b>
2 sides can open independently Tough Transparent lids Adjustable partitions Total of 32 Compartments Size: 295L x 220H x 76Wmm	2 sides can open independently Tough Transparent lids Adjustable partitions Total of 22 Compartments Size: 370L x 300H x 80Wmm	Single Lid opening Tough Transparent lid Adjustable partitions Total of 26 Compartments Size: 460L x 360H x 80Wmm	4 Pull-out drawers Single Top compartment with Transparent lid Total of 21 Compartments Size: 415L x 225H x 240Wmm	3 Pull-out drawers 2 Top Compartments with Transparent lids Total of 17 Compartments Size: 400L x 205H x 290Wmm
Small 2 Door Storage Box	Accessory Box	Storage Box	Component Separator Box	Aluminium Tool Case
<b>ZD-B3</b>	<b>MJ-10310</b>	<b>HL3021</b>	<b>ZD-B4</b>	<b>SB210310</b>
2 sides can open independently Tough Transparent lids Fixed partitions Total of 13 Compartments Size: 162L x 99W x 45Hmm	Single Lid opening Tough Clear lid/ Quick view Fixed partitions Total of 18 Compartments Size: 310L x 200W x 45Hmm	Single Lid Opening Tough Transparent Lid Total of 26 Adjustable Compartments Size: 460L x 330W x 75Hmm	Single Pull-out drawer Small compact Clear Tray View from sides Total of 3 Compartments Size 156L x 92W x 53Hmm	Aluminium Carry Case Formed Foam Cut-outs Adjustable partitions Total of 6 Compartments Size: 460L x 335W x 150Hmm

## SHELVING

The economical, aesthetically pleasing, DIY, quick assembly (no screws) shelving. Ideal for the Store, Garage, Workshop, Office or the Garden Shed



Code	ADIY3903W	ADIY3904G	ADIY3901W	ADIY3902G
Colour	White	Grey	White	Grey
Description	5 Shelf, Loading: Max 250kg per Shelf, Up to 1250kg Total Weight Size: 1830 x 920 x 458mm		4 Shelf, Loading: Max 150kg per Shelf, Up to 600kg Total Weight Size: 1524 x 814 x 305mm	

• Heavy steel profile uprights • Removable shelves • Easy and quick erection • Available in Grey or White

## TOOL CABINETS & WORKBENCHES

**Heavy Duty Workbenches** • Load Capacity: 1000kg • Drawer Loading Capacity: 100kg  
 • Laminated Tops • Optional extra: Rack set **WQ-62** & **WQ-63**

	Work Bench Only	c/w 3 x Drawers	c/w 3 Drawer Cabinet
<b>Code</b>	<b>WA-67A-1</b>	<b>WAT-6203A-1</b>	<b>WAS-64031A-1</b>
Size (mm)	800H x 1800W x 750D	800H x 1800W x 750D	800H x 1800W x 750D

**Standard Workbenches** • Load Capacity: 600kg • Drawer Loading Capacity: 60kg each  
 • Laminated Tops • Optional extra: Rack set **WQ-62** & **WQ-63**

	Perforated Rack Sets	c/w 2 x Drawers	c/w 4 Drawer Cabinet
Works with both heavy-duty and standard workbenches			
<b>Code</b>	<b>WQ-62</b>	<b>WQ-63</b>	<b>WBS-63021F</b>
Size (mm)	605H x 1802W x 205D	605H x 1802W x 325D 25H x 1795W x 300D	800H x 1800W x 750D

## TRESTLES & PORTABLE WORK BENCHES

	Height Adjustable Trestle	Portable Work Benches	
		OPEN	CLOSED
<b>Code</b>	<b>HL4020-H</b>	<b>HL4020-C</b>	<b>RWM-WB002</b>
Size (mm)	1055W x 475L x 800-920H	700W x 590L x 880H	605W x 630D x 780H
Carrying Capacity	350kg/Pair	200kg	-

## TROLLEYS & MINI STEP LADDER

Trolleys	Trolley for moving appliances up to 100kg	NEW	Plastic Step-Ladder
<b>HL2031</b>	<b>HL5039</b>	<b>ZYD-01</b>	<b>HL3028</b>
Service Cart Maximum load 30kg/level 715 x 465 x 250mm	Home Trolley (set of 2) Maximum load 100kg/set	Multipurpose Folding Trolley Maximum load 240kg 560 x 380 x 100(H)mm	Top Ø286mm Bottom Ø435mm Height 425mm Maximum load 300kg



## STORAGE BINS

### Hanger Bins – Material: Polypropylene

<b>Code</b>	<b>TKI-8301</b>	<b>TKI-8302</b>	<b>TKI-8303</b>	<b>TKI-8304</b>	<b>TKI-8305</b>
Size (mm)	50H x 105W x 110L	75H x 105W x 140L	75H x 105W x 190L	125H x 140W x 220L	125H x 140W x 270L
Colour	Red	Blue	Yellow	Blue	Red

• Each Bin supplied with index label • All of the above Bins are designed to assemble (interlock) onto the Louvred Hanger Board, see KH-306 below

### Team Bins – Material: Polypropylene

<b>Code</b>	<b>TKI-810</b>	<b>TKI-815</b>	<b>TKI-820</b>	<b>TKI-854</b>	<b>TKI-855</b>
Size (mm)	75H x 100W x 160L	124H x 150W x 240L	155H x 200W x 340L	177H x 200W x 450L	177H x 300W x 450L
Colour	Yellow	Red	Blue	Blue	Blue

• Optional Extra: Back Link Clips Code: **EBTK0892**  
 • Each Bin supplied with index label and four supporting poles for interlocking Bins vertically  
 • Interlockable slots on either side ensure Bins are kept locked side by side

	<b>Code</b>	<b>EBTK0892</b>
		Back Link Clips per 100

### Universal Team Bins – Material: • ABS Cabinet. • Polyethylene Drawers

Interlockable from left to right or top to bottom

<b>Code</b>	<b>TKI-301</b>	<b>TKI-302</b>	<b>TKI-303</b>	<b>TKI-304</b>
Cabinet Size (mm)	86H x 128W x 195D	86H x 128W x 195D	86H x 128W x 195D	86H x 128W x 195D
Drawers (included)	73H x 112W x 167D (1pcs)	35H x 116W x 167D (2pcs)	73H x 48W x 167D (2pcs)	35H x 53W x 167D (4pcs)

• Each Bin supplied with index label

### Mobile Storage Bin Rack

	c/w 64 small bins and 30 large bins. Small bin: 75H x 105W x 165L Large bin: 125H x 150W x 240L
<b>HL3201</b>	
	Size: 940 x 500 x 1250mm

### Document Cabinets – Material: • 0.7mm cold Steel Plate Cabinet • Polyethylene Drawers

<b>Code</b>	<b>A4G-345</b>	<b>TKI-2405</b>	<b>A4G-106</b>	<b>A4HG-10203</b>	<b>A4H-104</b>
Cabinet Size (mm)	880H x 812W x 346D	310H x 460W x 230D	360H x 260W x 346D	360H x 260W x 346D	360H x 260W x 346D
Drawers (included)	45H x 230W x 326D (A4) (46pcs)	52H x 100W x 220D (20pcs)	45H x 230W x 326D (A4) (6pcs)	71H x 230W x 326D (A4) (2pcs) 45H x 230W x 326D (A4) (3pcs)	71H x 230W x 326D (A4) (4pcs)

<b>Code</b>	<b>RM-530</b>	<b>TR-4116</b>	<b>B4HG-10203</b>	<b>B4H-104</b>
Cabinet Size (mm)	880H x 900W x 420D Bins included 30 x <b>TR-4116</b> (Bins) c/w 2 dividers per Bin Max dividers per Bin, 7	105H x 415W x 168D Spare Bins	360H x 300W x 414D (mm) 71H x 270W x 393D (B4) (2pcs) 45H x 270W x 393D (B4) (3pcs)	360H x 300W x 414D (mm) 71H x 270W x 393D (B4) (4pcs)

<b>TR-DIVIDER</b>	<b>Louvred Board – Material: 0.7mm cold Steel Plate</b>
Spare Dividers (3pcs)	<b>Code</b> <b>KH-306</b>
• Anti-Slip Device • Flexible Spacing • Colour Labels (included)	<b>Size (mm)</b> 900W x 450H

## ALUMINIUM LADDERS

Maximum Load 150kg



LS1108M

LS2108M

LS2206M

LJ503DR

LJG309DL

### LS - Range:

- Compact design
- Faster operation
- Safety lock

### LJ - Range:

- Strong mechanism
- Easy carry
- Light Weight

### LJG - Range:

- Extra wide tread for comfort during extended use
- High top hand rail for additional stability
- Robust construction

Code	Description	Open/Extended Height
LJ503DR	3 Step Aluminium Ladder	1230mm
LJ506DR	6 Step Aluminium Ladder	1890mm
LS1108M	8 Step Aluminium Telescopic Ladder	2550mm
LS1112M	12 Step Aluminium Telescopic Ladder	3750mm
LS2108M	6 + 8 Step Double Telescopic Ladder	2520mm
LS2206M	2 x 6 Step Folding Telescopic Ladder	1850mm
LJG306DL	6-Wide step aluminium ladder with tool tray	1945mm
LJG309DL	9-Wide step aluminium ladder with tool tray	2644mm

## UTILITY ROPES & CHAINS

### Ropes



RMP-0615

RMP-1015H

RMP-420H

RCB-512

RPC-430

RS-55HP

### Short Link Steel Chain



Code	Ø x Length	Type	Code	Ø x Length	Type	Code (30m)	Size Ø	Code (2m)	Size Ø
RMP-0615	6mm x 15m	Multipurpose	RPC-430	4mm x 30m	Para Cord	TOOC250	3mm	TOOC261	3mm
RMP-0823	8mm x 23m	Multipurpose	RS-55HP	5mm x 5m	Ski Rope	TOOC251	4mm	TOOC262	4mm
RMP-1030	10mm x 30m	Multipurpose	RS-510HP	5mm x 10m	Ski Rope	TOOC252	5mm	TOOC263	5mm
RMP-1215	12mm x 15m	Multipurpose	RS-530HP	5mm x 30m	Ski Rope	TOOC253	6mm	TOOC264	6mm
RMP-1015H	10mm x 15m	M/P on Reel	RS-710HP	7mm x 10m	Ski Rope	TOOC254	7mm	TOOC265	7mm
RMP-420H	4mm x 20m	M/P on Reel	RS-730HP	7mm x 30m	Ski Rope	TOOC255	8mm		
RMP-620H	6mm x 20H	M/P on Reel	RS-1015HP	10mm x 15m	Ski Rope	TOOC256	10mm		
RCB-512	5mm x 12m	Cotton Blend	RS-1030HP	10mm x 30m	Ski Rope				

• For Lifting Purposes      • Steel-Wire Electro-Galvanised

## TIE DOWN STRAPPING

	2pcs	4pcs	12pcs	
<b>Code</b>	<b>RTD-25X5M/1P</b>	<b>RTD-25X5M/2P</b>	<b>RTD-25X5M/4P</b>	<b>TDK-12P</b>
Strap size	25mm x 5m	25mm x 5m	25mm x 5m	2 x 25mm Tie Down Straps with buckle
Breaking Strain	500kg	500kg	500kg	2 x 2.5m x 25mm Tie Down Ratchet with Hook
Includes	1 x Ratchet Tie Down Strap with S Hooks	2 x Ratchet Tie Down Strap with S Hooks	2 x Ratchet Tie Down with Hooks + Tie Down Straps 2 Buckles	8 x 8mm Bungee Cords 400,600, 800,1000mm
	2pcs	5pcs		
<b>Code</b>	<b>RTD-50x6M/1P</b>	<b>RTD-38X5M/2P</b>	<b>TDK-5P</b>	<b>Bungee Cords</b>
Strap size	50mm x 6m	38mm x 5m	3.5m x 25mm Tie Down strap   4 x 4.5mm	<b>BC-8X800/2P</b> 8mm x 800mm
Breaking Strain	1300kg	2000kg	Bungee Cords	<b>BC-8X800/4P</b> 8mm x 800mm
Includes	1 x J Hooks	J Hook		<b>BC-10X2000/2P</b> 10mm x 2000mm
				c/w 3.2mm Steel Hooks

Leading manufacturer, importer, and distributor of high-quality electrical and solar products tailored for both industrial and residential sectors. With an extensive network of distributors and franchises spanning across South Africa, we ensure superior service and widespread availability of our products, that meets the highest standards of performance and innovation.

**LONGMEADOW**

26 Nguni Drive  
Longmeadow Business  
Estate West, Edenvale  
Gauteng

**010 202 3300**

[info@acdc.co.za](mailto:info@acdc.co.za)

**GERMISTON**

Sharland Street  
Driehoek  
Germiston  
Gauteng

**011 418 9600**

[germiston@acdc.co.za](mailto:germiston@acdc.co.za)

**RIVERHORSE**

6 Riverhorse Close  
Riverhorse  
Valley Business Estate  
Durban

**031 492 4800**

[rvh@acdc.co.za](mailto:rvh@acdc.co.za)

**PINETOWN**

Unit 10  
Pine Industrial Estate  
Pineside Road  
New Germany

**031 700 4215**

[kzn@acdc.co.za](mailto:kzn@acdc.co.za)

**CAPE TOWN**

3(b) Richmond Southern  
Close, Lenie Adams Ave  
Richmond Park

**021 492 2000**

[cape@acdc.co.za](mailto:cape@acdc.co.za)

National Sales Centre: **010 202 3400** | Technical: **010 202 3500** | Solar Hotline: **010 045 8002**



[www.acdc.co.za](http://www.acdc.co.za)



THINK ELECTRICAL



Note that specifications may undergo updates without prior notification in this publication. © ACDC Dynamics