



INDUSTRIAL & COMMERCIAL LIGHTING

Explore our comprehensive lighting range, featuring residential, commercial, industrial, and festive options to suit every need. Whether for home, business, or special occasions, our catalogue offers versatile solutions to illuminate any space.

ACDC
DYNAMICS

THINK ELECTRICAL

INDEX

ITEMS	Page				
Lamps	1-23	LED Recessed Office	49	Ignitors	144-146
LED T8 Tubes	1-3	T8 Fluorescent Recessed Office	50	Emergency	142-152
LED T5 Tubes	3	LED Linear	51	Emergency Kits	147
LED GU10/MR16	4-5	Adjustable LED Linear	52	Emergency Lights	148-152
LED Candle	6	LED Batten	53	Specialized	153-154
LED Golf Balls	6	Wall / Ceiling	54	Chicken Farming Lights	153
LED A60	7	Under Counter	54	LED UVC Lights	154
LED High Power	7	Open Channels	55-56	Plant Grow Lights	153
LED Reflector lamp	8	Down Lights	57-65	Portable	155-158
LED E27 Downlight	8	Down Light Fittings	66-68	Torches	157-158
LED Filament	9	Track Lights	69-71	Head Lamps	156
LED Decor Lamp	10-11	Cabinet Lights	71-75	Bicycle Lights	156
LED Decorative DNA	11	DC Lights	76-77	Camping Lights	156
LED 2U/3U/4U	12	Strip Lights	78-83	Work Lights	156
LED Corn	12-13	Strip Light Kits	84-85	Ornamental	159-160
LED Compact	13	Hexagon LED Tiles	85	Music Lights	159
LED High Power	13-14	Profiles	86-89	Colour Changing	159
LED Modules	14	Specialized Strips	90	Festive	160-169
LED PAR	15	Strip Connectors	90	Belt Lights	160
LED Infrared PAR38	15	LED Modules	91-92	Rope Lights	161-162
LED Pygmy	16	Edge Lit Lights	92	Projectors	162
LED G9/JC/G4/G12	17	Back Lit Light Box	92	Curtain Lights	163-165
LED R7S	17	Outdoor	93-118	3D Motif	166-167
LED PLL	18	Floor Lights	93	Mini Rope Motif	167-169
LED Retro Fit	18	Wall Lights	93	Display	170
LED Flame Lamps	19	Deck Lights	94	Test Case	170
LED Smart Lamps	19-20	Inground Lights	95	Shelf Light	170
LED Fluorescent PL /20	21	Spike Lights	96-97	Shower Heads	170
LED Fluorescent Tubes	21	Bollards	98-99	Stage	171
LED Black UV Lamps	21	Post Tops	100	PAR Cans	171
LED HID	22-23	Poles	100	Search Lights	171
Industrial	24-47	Underwater Lights	101	Laser Light	171
LED Floodlights	24-28	Pool Lights	101-103	Clearance	172-206
LED Work Lights	29	Foot Lights	104		
Portable Floodlights	33-34	Wall Recessed	105		
Billboard Floodlights	30	Wall Surface	106		
LED Wall Washers	30	Bulkheads	107-112		
HID Highmast Floodlights	31	Wall Lights	112-116		
HID Floodlights	31	Up/Down Lights	117-118		
Empty Floodlights	31	Indoor	119-126		
Plastic Energy Saving Floodlights	32	Up/Down Lights	119		
HID Stadium Floodlights	33-34	Wall Lights	119-120		
LED Highbays	33-34	Ceiling Lights	121-123		
HID Highbays	35	Ceiling Spot Lights	123-125		
Empty Highbays	35	Picture Lights	125-126		
LED Linear Highbays	36	Linear Ceiling	126		
LED T-Bays	36	Accessories	127-146		
HID Lowbays	36	Decorative Cord	127		
LED Gas Station Lights	37	Decorative Accessories	127		
LED Parking Bay Lights	37	Switches	128		
LED Street Lights	38-39	LED Surge Protection	128		
HID Street Lights	40	Lamp Holders	129-130		
PL Street Lights	40	Sensors	131-134		
Empty Street Light	40	Strip Controllers	137		
LED Bulkheads	41	Dimmers	156		
LED Bulkheads Retrofit Kits	41	Timers	138-140		
HID Bulkheads	42	DMX Controllers	142		
LED Wall Panels	42	Constant Voltage Drivers	143		
Empty Bulkheads	42	Constant Current Drivers	143-144		
Vapour Proof	43-36	Dimmable Electronic	144-146		
Commercial	57-112	Transformers	161-162		
Linear Lights	46-47	Transformers	143		
LED Panels	48-49	Electronic Ballasts	163		
		Magnetic Ballasts	164-168		

LED T8 TUBULAR LIGHTING

- WW - 2700K
- CW - 4200K
- DL - 6000K

2 Year Warranty



T8 LED Tubes - Glass - Supply Voltage: 230-240VAC | Non-Dimmable | **CRI: 70** | Diameter: 26.3mm | Power factor: >0.95 | Efficiency: 90lm/W | Single End Wired | Can operate in temperatures between -10°C to +45°C

Code FROSTED	Code CLEAR	Length	Lumen	Power	*Add colour to code
LEDT8-A2FR-*	LEDT8-A2C-*	600mm (2FT)	700-800lm	9W	
LEDT8-A3FR-*	LEDT8-A3C-*	900mm (3FT)	860-950lm	13W	WW / CW / DL / ●R /
LEDT8-A4FR-*	LEDT8-A4C-*	1200mm (4FT)	1480-1600lm	18W	●GN / ●BL / ●Y
LEDT8-A5FR-*	LEDT8-A5C-*	1500mm (5FT)	1750-1900lm	22W	
LEDT8-A8FR-*	-	2365mm (8FT)	3200lm	36W	CW / DL

Note: Colour only available in frosted tubes.

* For DC add to code: 12VDC, 24VDC, 48VDC. **Note:** DC Tubes available in frosted and clear

- CW - 4200K
- DL - 6000K

3 Year Warranty



T8 LED Tubes - PC - Supply Voltage: 85-265VAC | Non-Dimmable | **CRI: 80** | Diameter: 26.3mm | PF 0.95 | Efficiency: 90lm/W | Single End Wired | With MOV Surge Protection | 270° View Angle | Can operate in temperatures between -10°C to +45°C

Code	Length	Lumen	Power	*Add colour to code
LEDT8-A2FR-*/PC	600mm	800lm	9W	CW / DL
LEDT8-A4FR-*/PC	1200mm	1600lm	18W	CW / DL
LEDT8-A5FR-*/PC	1500mm	1900lm	22W	CW / DL

- CW - 4200K
- DL - 6000K

5 Year Warranty



T8 LED Tubes - PC / Aluminium - Supply Voltage: 85-265VAC Wide Range | Non-Dimmable | **CRI: 80** | Diameter: 26.3mm | Power Factor: >0.95 | **Efficiency: 160lm/W** | Single End Wired | Flicker Free | Can operate in temperatures between -20°C to +45°C

Code FROSTED	Length	Lumen	Power	*Add colour to code
T8-5Y-A2FR-*	600mm (2FT)	1440lm	9W	CW / DL
T8-5Y-A3FR-*	900mm (3FT)	2080lm	13W	CW / DL
T8-5Y-A4FR-*	1200mm (4FT)	2880lm	18W	CW / DL
T8-5Y-A5FR-*	1500mm (5FT)	3520lm	22W	CW / DL

- CW - 4200K
- DL - 6000K



T8 LED Tubes - Dimmable - Supply Voltage: 220-240VAC | **CRI: 80** | Diameter: 26.3mm | Efficiency: 90lm/W | Power factor: >0.95 | Glass Tube | TRIAC Dimming

Code	Length	Lumen	Power	*Add colour to code
DIMT8-A2FR-*	600mm	800lm	9W	CW / DL
DIMT8-A4FR-*	1200mm	1600lm	18W	CW / DL
DIMT8-A5FR-*	1500mm	1900lm	22W	CW / DL

- CW - 4200K
- DL - 6000K



T8 LED Tubes - Single Pin - Supply Voltage: 230VAC | Diameter: 26mm | Glass | Power factor: >0.95

Code Frosted	Length	Lumens	Power	*Add colour to code
LEDT8SP-A4FR-*	1200mm (4ft)	1710lm	18W	CW / DL
LEDT8SP-A5FR-*	1500mm (5ft)	2090lm	22W	CW / DL
LEDT8SP-A8FR-*	2365mm (8ft)	3420lm	36W	CW / DL

LED T8 TUBULAR LIGHTING

- CW - 4200K
- DL - 6000K



Could be used inside waterproof fittings or behind a diffuser

T8 Microwave Motion Sensing SMD LED Tubes - 85-265VAC | Intelligent microwave motion sensing technology | Motion detection angle: 180° | Motion detection range: ≤10m

Code	Length	Lumen	Power	Replaces T8 Lamp	*Add colour to code
LEDT8MW-A2FR-*	600mm	800-850lm	9W	18W (2FT)	CW / DL
LEDT8MW-A3FR-*	900mm	1450-1500lm	15W	30W (3FT)	CW / DL
LEDT8MW-A4FR-*	1200mm	1750-1850lm	18W	36W (4FT)	CW / DL
LEDT8MW-A5FR-*	1500mm	2100-2200lm	22W	58W (5FT)	CW / DL

- CW - 4200K
- DL - 6000K



T8 PIR Motion Sensing SMD LED Tubes - 85-265VAC | PIR detection angle: 120° | PIR Range: 5-7m | Turn off delay: 30 seconds | Switch on time: 0.5s from detection

Code	Length	Lumen	Power	Replaces T8 lamp	*Add colour to code
LEDT8S-A2FR-*	600mm	800-850lm	9W	18W (2FT)	WW / CW / DL
LEDT8S-A3FR-*	900mm	1100-1200lm	13W	30W (3FT)	WW / CW / DL
LEDT8S-A4FR-*	1200mm	1750-1850lm	19W	36W (4FT)	WW / CW / DL
LEDT8S-A5FR-*	1500mm	2100-2200lm	22W	58W (5FT)	WW / CW / DL

- CW - 4200K
- DL - 6000K



2 Year Warranty

T8 Waterproof LED Tubes - PC IP65 - 180 - 265VAC | Non-Dimmable | CRI > 80 | Diameter 26mm | Power Factor 0.95 | Efficiency: 100lm/W | Operating Temp -10° to +45°C | Waterproof PC End Caps | Connection wire length 500mm

Code	Length	Lumen	Power	*Add colour to code
XGY-T8-A2FR-*	600mm	850lm	9W	CW / DL
XGY-T8-A3FR-*	900mm	1500lm	15W	CW / DL
XGY-T8-A4FR-*	1200mm	3600lm	18W	CW / DL
XGY-T8-A5FR-*	1500mm	5800lm	22W	CW / DL



T8 Food Display (Butcher) SMD LED Tubes - 85-265VAC | These lamps are specially designed to ensure that food is displayed in an appetizing light. The light generated by the lamp makes meat, bread and other food look fresh and appealing. Also because LED lamps have no glass in their construction they are especially suitable for the food industry.

Code	Length	Power	Replaces T8 Lamp
LEDT8BL-A2FR	600mm	9W	18W (2FT)
LEDT8BL-A3FR	900mm	15W	30W (3FT)
LEDT8BL-A4FR	1200mm	18W	36W (4FT)
LEDT8BL-A5FR	1500mm	22W	58W (5FT)

See page 89 for shelf tag with butcher strip light

- CW - 4200K
- DL - 6000K



3 Year Warranty

T8 Medical LED Tubes IP65 - 85-265VAC | With COI (Cyanosis Observation Index) < 2.5, Lantis LED Tubes are suitable for medical lighting application within hospitals in operating theatres, patient treatment rooms, consulting rooms, accident / trauma emergency areas that require close colour rendition of skin | RA > 90

Code	Length	Lumen	Power	Replaces T8 lamp	*Add colour to code
LTS-T8-A2FR-*	600mm	1000 - 1100lm	10W	18W (2FT)	CW / DL
LTS-T8-A4FR-*	1200mm	1500 - 1600lm	16W	36W (4FT)	CW / DL
LTS-T8-A5FR-*	1500mm	2200 - 2500lm	23W	58W (5FT)	CW / DL

T8 UVC LED Tubes - Input Voltage: 85-265VAC | 120° Beam Angle | Wavelength Range 270-280nm | Peak Wavelength 275nm | Radiant Flux max 5mW | Ceramic Substrate and Quarts Glass | Highly effective against inactivating and destroying the DNA of micro organisms found in mould, germs, bacteria and viruses.

Code	Wattage	Spectrum	Size (mm)
LEDT8-UVC-A2	9W	UVC	600 (2ft)
LEDT8-UVC-A4	15W	UVC	1200 (4ft)
LEDT8-UVC-A5	20W	UVC	1500 (5ft)

NEW



2-year warranty on all LED products & 1-year warranty on battery-operated products, unless specified. LED warranty void without surge protection. Refer to page 128.

LED T8 TUBULAR LIGHTING



T8 LED for Walk-In Freezers - 220-240VAC | Significant energy & maintenance cost savings | Improved illumination of products | Reduced heat | Environmentally-friendly - no mercury | No glass breakage | No UV light | Aluminium Backing & PC Diffuser | Operating temp.: -10 ~ 40°C

Code	Length	Power
LETT8-26W	1700mm	26W



T8 Plant Growing SMD LED Tubes - 85-265VAC | 75% Blue, 25% Red | Plant grow lamps have LED's that produce light in Blue (450nm) and Red (660nm) wavelengths that are ideal for promoting photo-biological processes in plants. These lamps can be used wherever plants do not receive enough natural light or in agricultural applications. For more see page 157

Code	Length	Power	Replaces T8 Lamp
LEDT8PG-A2FR	600mm	9W	18W (2FT)
LEDT8PG-A3FR	900mm	15W	30W (3FT)
LEDT8PG-A4FR	1200mm	18W	36W (4FT)
LEDT8PG-A5FR*	1500mm	22W	58W (5FT)

* Add **-IP65** to code for Weatherproof Tube. Waterproof Tube requires additional mounting clips (see page 3)

- CW - 4200K
- DL - 6000K



T8 LED Tubes - Maintained Emergency - With Internal Battery | Supply Voltage: 230VAC | Maintained emergency lighting luminaires are built to be active continuously in every day life, and through the event of a power cut, irrespective if switch is on or off | Emergency Back-Up Time: 3 Hours @ 300lm

Code	Length	Lumen	Power	*Add colour to code
EMG-M-LEDT8-A2FR-*	600mm	800lm	9W	CW / DL
EMG-M-LEDT8-A4FR-*	1200mm	1600lm	18W	CW / DL
EMG-M-LEDT8-A5FR-*	1500mm	1900lm	22W	CW / DL

NEW

- CW - 4200K
- DL - 6000K



T8 LED Tubes - Non-Maintained Emergency - With Internal Battery | Supply Voltage: 230VAC | Emergency Back-Up Time: 1 Hour @ 300lm | **Emergency only works when switch is on and mains fail** | Tube to be wired independantly

Code	Length	Lumen	Power	*Add colour to code
EMG-LEDT8-A2FR-*	600mm	800lm	9W	CW / DL
EMG-LEDT8-A4FR-*	1200mm	1600lm	18W	CW / DL
EMG-LEDT8-A5FR-*	1500mm	1900lm	22W	CW / DL

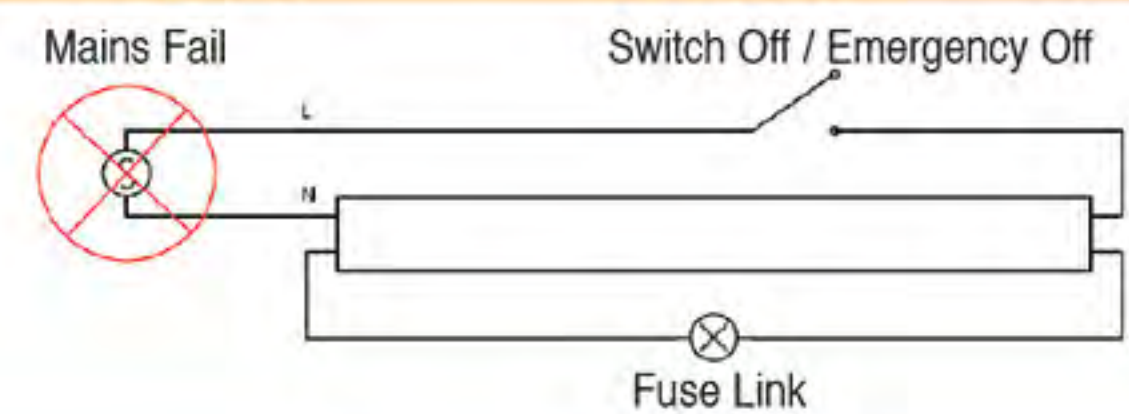
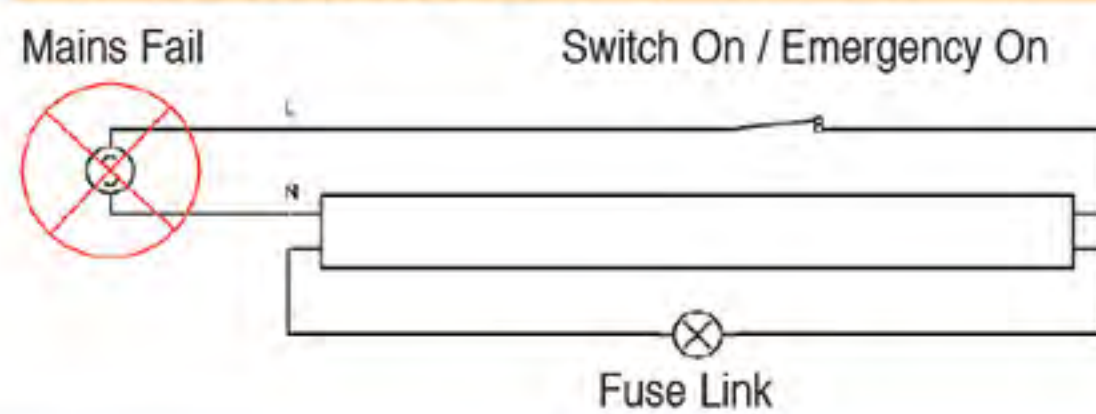

Lamps



Accessories for T8 Tubes

Code	Description
EL-FL	Fuse Link to replace Starter
LEDT8-CLIP	CLIP for mounting of Tube in Lightbox
LEDT8-LLH	Loose Lamp Holder
LEDT8-CONL	1.5m T8 Connector Lead

LED T5 TUBULAR LIGHTING

- CW - 4200K
- DL - 6000K

LED T5 Tubes - 220-240VAC | Diameter: 19mm | Power factor: >0.95 | Efficiency: 80lm/W | Material: Aluminium + PC

Frosted Code	Length	Wattage	Lumen	*Add colour to code
LEDT5-A2FR-*	550mm (2FT)	7W	580lm	CW / DL
LEDT5-A3FR-*	900mm (3FT)	14W	1120lm	CW / DL
LEDT5-A4FR-*	1150mm (4FT)	16W	1280lm	CW / DL
LEDT5-A5FR-*	1450mm (5FT)	22W	1600lm	CW / DL

INTERNAL DRIVER

LED GU10 - 230VAC

		Non-Dimmable				
<ul style="list-style-type: none"> ○ WW - 2700K ○ CW - 4200K ○ DL - 6000K 						
		Single	Single	5 Pack	Single	
	Code	SMD-GU10-3W-*	SMD-GU10-6W-*	LED-GU10-6W-*/5	HS-GU10-5W-*	
	Wattage	3W	6W	6W	5W	
	Lumens	240lm	480lm	480lm	450lm	
Beam Angle	120°	120°	120°	45°		
*Add Colour to Code	●R / ●GN / ●BL / ●Y	WW / CW / DL	WW / CW / DL	WW / CW		
		Non-Dimmable				
<ul style="list-style-type: none"> ○ WW - 2700K ○ CW - 4200K ○ DL - 6000K 		NEW				
		Single	5 Year Warranty	Single		
	Code	KL-GU10-7W-*	HS-GU10-5W-*-5Y	GU10-3528-60-*		
	Wattage	7W	5W	3W		
	Lumens	500lm	350lm	380lm		
Beam Angle	38°	48°	120°			
*Add Colour to Code	WW / CW	WW / CW / DL	WW / CW / DL			
		Dimmable				
<ul style="list-style-type: none"> ○ WW - 2700K ○ CW - 4200K ○ DL - 6000K 		NEW				
			5 Year Warranty			
	Code	DIM-KL-GU10-7W-*	DIM-GU10-5W-*-5Y	DIM-MS-GU10-5W-*	DIM-GU10-5W-*	
	Wattage	7W	5W	5W	5W	
	Lumens	560lm	350lm	380lm	450lm	
Beam Angle	38°	48°	120°	38°		
*Add Colour to Code	WW / CW / DL	WW / CW / DL	WW / CW / DL	WW / CW		
		1.5hrs Emergency		Emergency 3 Step Dimming		
<ul style="list-style-type: none"> ○ WW - 2700K ○ CW - 4200K ○ DL - 6000K 	NEW	NEW				
		EMG	EMG	EMG		
	Code	EMG-GU10-3W-*	EMG-GU10-5W-*	EMG-DIM-GU10-7W-*		
	Wattage	3W	5W	7W		
	Lumens	Normal: 190lm Emergency: 85lm	Normal: 350lm Emergency: 120lm	Normal: 450lm Emergency: 135/60/24lm		
Beam Angle	120°	120°	120°			
*Add Colour to Code	WW / CW / DL	WW / CW / DL	WW / CW / DL			

Lamps

LIGHTING

LED MR16 - 12V

Non-Dimmable

- WW - 2700K
- CW - 4200K
- DL - 6000K



12V



12V



12V



12V

Code	SMD-MR16-6W-*	HS-MR16-5W-*	KL-MR16-7W-*	MR16-3528-60-*
Wattage	6W	5W	7W	3W
Lumens	480lm	350lm	500lm	380lm
Beam Angle	120°	45°	38°	120°
*Add Colour to Code	WW / CW / DL	WW / CW	WW / CW	WW / CW

Non-Dimmable

- WW - 2700K
- CW - 4200K
- DL - 6000K



12V

NEW



12V

5 Year Warranty



230VAC

Code	HS-MR16-1X3W-*	HS-MR16-5W-5Y	HS-MR16-1X3W-230
Wattage	3W	5W	3W (1 x 3W)
Lumens	200lm	350lm	240lm
Beam Angle	60°	48°	28°
*Add Colour to Code	WW / CW / ●R / ●GN / ●BL / ●Y	WW / CW / DL	WW / CW

Dimmable

- WW - 2700K
- CW - 4200K
- DL - 6000K



230VAC



12V



230VAC

Code	HS-MR16-3X1W-230	DIM-MR16-35-60-*	DIM-MR16-35-60-230
Wattage	3W (3 x 1W)	4W	4W
Lumens	200lm	380lm	380lm
Beam Angle	60°	120°	120°
*Add Colour to Code	WW / CW	CW / DL	CW

Dimmable

- WW - 2700K
- CW - 4200K
- DL - 6000K

NEW



12V



12V



12V

Code	DIM-MS-MR16-5W-*	DIM-MR16-5W-*	DIM-KL-MR16-7W-*
Wattage	5W	5W	7W
Lumens	380lm	450lm	670lm
Beam Angle	120°	38°	38°
*Add Colour to Code	WW / CW / DL	WW	WW / CW

Lamps

LIGHTING

LED CANDLE LAMPS - 230VAC

Non-Dimmable						Value Packs
○ WW - 2700K ○ CW - 4200K						
Code E14	T-LEDB35R-E14-*	-	-	T-LEDC35L-E14-*	SP-E14-CLH37-*	T-LEDB35R-E14-*/3
Code E27	-	T-LEDB35R-E27-*	-	-	-	-
Code B22	-	-	T-LEDB35R-B22-*	-	-	-
Wattage	3W	3W	3W	3W	1.6W	3W
Base	E14	E27	B22	E14	E14	E14 / E27 / B22
Lumens	245lm	245lm	245lm	245lm	-	245lm
Beam Angle	180°	180°	180°	180°	180°	180°
*Add colour to code	WW / CW	WW / CW	WW / CW	WW / CW	WW / CW / ●R / ●GN / ●BL / ●Y	WW / CW

Dimmable						
○ WW - 2700K ○ CW - 4200K						
Code	LEDC212-*	LEDC35E-E27-*	LEDC35E-B22-*	LEDC35E-B15-*	LEDC35L-E14-*	
Wattage	5W	5W	5W	5W	5W	
Base	E14	E27	B22	B15D	E14	
Lumens	400lm	400lm	400lm	400lm	400lm	
Beam Angle	270°	270°	270°	270°	270°	
*Add colour to code	WW / CW	WW / CW	WW / CW	WW	WW / CW	

LED GOLF BALL LAMPS - 230VAC

Non-Dimmable			Dimmable
○ WW - 2700K ○ CW - 4200K			
Code	T-LEDG50R-E14-*	T-LEDG50R-E27-*	T-LEDG50R-B22-*
Wattage	3W	3W	3W
Base	E14	E27	B22
Lumens	245lm	245lm	245lm
Beam Angle	180°	180°	180°
*Add colour to code	WW / CW	WW / CW	WW / CW

Colour Lamps		Value Packs
○ WW - 2700K ○ CW - 4200K		
Code	LE45-0.6-E27-*/2	LE45-0.6-B22-*/*
Wattage	1W	1W
Base	E27	B22
Lumens	-	-
Beam Angle	270°	270°
*Add colour to code	WW / CW / ●R / ●GN / ●BL / ●Y	WW / CW / ●R / ●GN / ●BL / ●Y / ●O (Orange) / ●●●●●OM

*Add pack size to code: /2 (2 Pack), /5 (5 Pack - only mixed colours)

LED LAMPS - 230VAC

	Non-Dimmable G95 (Ø95mm)		Non-Dimmable G125 (Ø125mm)		LED Pendant Lamp	
○ WW - 2700K ○ CW - 4200K					Supply Volts 230VAC * Add Wattage to Code: 16W, 33W	
Code	G95-E27-12W-*	G95-E27-15W-*	G120-E27-15W-*	G120-E27-18W-*	LED-CL18-*-CW	
Wattage	12W	15W	15W	18W	*16W	*33W
Base	E27	E27	E27	E27	E27	E27
Lumens	960lm	1200lm	1200lm	1600lm	1440lm	2970lm
Beam Angle	270°	270°	270°	270°	-	-
Size (mm)	-	-	-	-	Ø140 x 90	Ø254 x 127
*Add colour to code	WW / CW	WW / CW	WW / CW	WW / CW	CW (4200K)	CW (4200K)

Non-Dimmable Reflector Type

○ WW - 2700K ○ CW - 4200K						
Code	LED-R39-3W-*	LED-R50-3W-*	LED-R50-6W-*	LED-R63-4.5W-*	LED-R63-8W-*	LED-R80-10W-*
Wattage	3W	3W	6W	4.5W	8W	10W
Base	E14	E14	E14	E27	E27	E27
Lumens	240lm	240lm	540lm	360lm	720lm	850lm
Beam Angle	160°	160°	160°	160°	160°	160°
*Add colour to code	WW / CW	WW	WW / CW	WW	WW / CW	WW / CW

Dimmable Reflector Type

○ WW - 2700K ○ CW - 4200K				
Code	DIM-R39-3W-*	DIM-R50-6W-*	DIM-R63-8W-*	DIM-R80-10W-*
Wattage	3W	6W	8W	10W
Base	E14	E14	E27	E27
Lumens	240lm	540lm	720lm	850lm
Beam Angle	160°	160°	160°	160°
*Add colour to code	WW / CW	WW / CW	WW / CW	WW / CW

Non - Dimmable JDR Lamps

	Non - Dimmable JDR Lamps					Dimmable JDR
○ WW - 2700K ○ CW - 4200K						
Code	T-LEDJDRR-*	HS-JDR-1X3W-*	HS-JDR-3X1W-*	HS-JDR-3X2W-*	HS-JDR-5W-*	DIM-E27
Wattage	4W	3W	3W	6W	5W	6W
Base	E27	E27	E27	E27	E27	E27
Lumens	250-280lm	200lm	240lm	340-360lm	330-350lm	380lm
Beam Angle	280°	60°	38°	38°	60°	38°
*Add colour to code	WW / CW	WW / CW	WW / CW / ● R / ● Y	WW / CW	WW / CW	WW / CW

LED IMITATION FILAMENT LAMP

LED Ball Lamps - Supply Voltage: 220-240VAC | CRI: 80 | 360° lighting to directly replace traditional incandescent lamp 20W, 40W & 60W. Special elongated LED encapsulation technique allows LED to give the same effect as an incandescent tungsten filament lamp.

Code	Code (Dimmable)	LED Power	Base	Lumen	Beam	Colour
B60-4W-E27-*	-	4W	E27	450lm	360°	WW / CW
B60-4W-B22-*	-	4W	B22	450lm	360°	WW / CW
B60-6W-E14-*	-	6W	E14	700lm	360°	WW / CW
B60-6W-E27-*	-	6W	E27	700lm	360°	WW / CW
B60-6W-B22-*	-	6W	B22	700lm	360°	WW / CW

LED Candle Lamp		• Supply Voltage: 220-240VAC		• CRI: 80		
C35-2W-E14-*	-	2W	E14	225lm	360°	WW / CW
C35-2W-E27-*	-	2W	E27	225lm	360°	WW / CW
C35-2W-B22-*	-	2W	B22	225lm	360°	WW / CW
C35-4W-E14-*	DIM-C35-4W-E14-*	4W	E14	350lm	360°	WW / CW
C35-4W-E27-*	-	4W	E27	450lm	360°	WW / CW
C35-4W-B22-*	-	4W	B22	450lm	360°	WW / CW

LED Flame Candle Lamp		• Supply Voltage: 220-240VAC		• CRI: 80		
C35L-2W-E14-*	DIM-C35L-2W-E14-*	2W	E14	245lm	360°	WW / CW
C35L-2W-E27-*	-	2W	E27	245lm	360°	WW / CW
C35L-2W-B22-*	-	2W	B22	245lm	360°	WW / CW
C35L-4W-B22-*	-	4W	B22	450lm	360°	WW / CW

LED Golf Ball Lamp		• Supply Voltage: 220-240VAC		• CRI: 80		
G45-2W-E14-*	-	2W	E14	245lm	360°	WW / CW
G45-2W-E27-*	-	2W	E27	245lm	360°	WW / CW
G45-2W-B22-*	-	2W	B22	245lm	360°	WW / CW
G45-4W-E27-*	-	4W	E27	450lm	360°	WW / CW

LED Reflective Lamp		• Supply Voltage: 220-240VAC		• CRI: 80		
R50-2W-E14-*	-	2W	E14	245lm	120°	WW / CW
R63-4W-E27-*	-	4W	E27	450lm	120°	WW / CW
R63-4W-B22-*	-	4W	B22	450lm	120°	WW / CW
R80-4W-E27-*	-	4W	E27	450lm	120°	WW / CW
R80-4W-B22-*	-	4W	B22	450lm	120°	WW / CW

LED Ball Lamp		• Supply Voltage: 220-240VAC		• CRI: 80		
G95-4W-E27-*	-	4W	E27	450lm	360°	WW / CW
G95-4W-B22-*	-	4W	B22	450lm	360°	WW / CW
G125-4W-E27-*	-	4W	E27	450lm	360°	WW / CW
G125-4W-B22-*	-	4W	B22	450lm	360°	WW / CW
G125-6W-E27-*	-	6W	E27	750lm	360°	WW / CW
G125-6W-B22-*	-	6W	B22	750lm	360°	WW / CW

LED Pear Shape Lamp		• Supply Voltage: 220-240VAC		• CRI: 80		
ST64-4W-E27-*	-	4W	E27	450lm	360°	WW / CW
ST64-4W-B22-*	-	4W	B22	450lm	360°	WW / CW
ST64-6W-E27-*	-	6W	E27	700lm	360°	WW / CW
ST64-6W-B22-*	-	6W	B22	700lm	360°	WW / CW

*Add colour to code: ○ CW (Cool White) 4000-4200K or ○ WW (Warm White) 2700-3000K

A60 LED FILAMENT PLANT GROW LAMP - E27

Input Voltage: 180 - 265VAC | Dimensions: Ø60 x 108mm | Full Colour Spectrum for general use | Ideal for greenhouse glass or plastic, Planting factory, Hydroponic shelves, Home Planting.

Code	Wattage	Colour Spectrum	PPF (400-700nm)	PAR Watt (W) (400-700nm)	EFF (PPF) (400-700nm)
XGY-A60-8-E27	8W	Full Spectrum	>12 μ mol	0.3 - 0.5mW	>1.5 μ mol/s/W

LED LAMPS (TO REPLACE MERCURY BLENDED LAMPS)

Supply Voltage: 90-265VAC

Code	Wattage	Base	Lumens	Size (mm)	Replace	Colour
HLT-E40-15W-*	15W	E40	2200lm	Ø46 x 195	-	CW / DL
HLE-E40-20W-*	20W	E40	2800lm	Ø90 x 225	80W	CW / DL
HLE-E40-30W-*	30W	E40	3800lm	Ø90 x 225	160W	CW / DL
HLE-E40-40W-*	40W	E40	5800lm	Ø118 x 290	250W	CW / DL

*Add colour to code: ○ CW (Cool White) 4000-4200K or ○ DL (Day Light) 6000K

2-year warranty on all LED products & 1-year warranty on battery-operated products, unless specified. LED warranty void without surge protection. Refer to page 128.

LED DECORATIVE LAMPS

Amber LED Filament Lamps - Dimmable 2200K

Supply Volts: 230VAC



Code	Wattage	Base	Filament Shape	Size (mm)	Colours
BF-G45-L	1W	E27	Loop	Ø45 x 74	WW
BF-A60-Q*	2W	E27 / B22	Quad	Ø60 x 105	WW
BF-C35-Q	2W	E14	Quad	Ø35 x 100	WW
BF-ST64-S	2W	E27	Spiral	Ø64 x 145	WW
NEW BF-G95-S	2W	E27	Spiral	Ø95 x 115	WW
BF-G125-S	2W	E27	Spiral	Ø125 x 170	WW
BF-T45-S	2W	E27	Spiral	Ø45 x 110	WW
AS-A60-ST*	2W	E27 / B22	Long	Ø60 x 105	WW
AS-C35-ST	2W	E14	Long	Ø35 x 100	WW
AS-ST64-ST	2W	E27	Long	Ø64 x 145	WW
NEW AS-G95-ST	2W	E27	Long	Ø95 x 115	WW
AS-G125-ST	2W	E27	Long	Ø125 x 170	WW
AS-T45-ST	2W	E27	Long	Ø45 x 110	WW
AS-T30-ST	2W	E27	Long	Ø30 x 295	WW

Clear LED Decorative Lamps - Scattered LED

Supply Volts: 230VAC



Code	Wattage	Base	Filament Shape	Size (mm)	Colours
DN-ST64*	3W	E27	Scattered	Ø64 x 150	WW / BL / V / S

* Add colour to code: ○ WW (Warm White) 2700K, ● BL (Blue), ● V (Violet), ● S (7 Colours)

3D Effect Lamps

Supply Volts: 230VAC



HB-A60-3D	6W	E27	Straight	Ø64 x 140	WW
HB-ST64-3D	6W	E27	Straight	Ø64 x 140	WW
HB-G125-3D	6W	E27	Straight	Ø125 x 176	WW

Twisted Wire

Supply Volts: 230VAC

WS-G95-WW	1.5W	E27	Twisted	Ø95 x 138	WW
WS-G125-WW	1.5W	E27	Twisted	Ø125 x 175	WW

Filament Text

Supply Volts: 230VAC

LVE-G125-4W-WW	4W	E27	Love	Ø125 x 176	WW
----------------	----	-----	------	------------	----

Irregular Lamp Shape

Supply Volts: 230VAC

IR-A165-4W-WW	4W	E27	Spiral	Ø160 x 300	WW
IR-BT150-6W-WW	6W	E27	Spiral	Ø150 x 225	WW

Shattered Glass Effect - 2700K | 360° Beam Angle

Supply Volts: 230VAC



Code	Wattage	Base	Filament Shape	Size (mm)	Colours
G130-1-WW	6W	E27	Straight	Ø130 x 180	WW
G130-2-WW	6W	E27	Straight	Ø130 x 180	WW
G130-3-WW	6W	E27	Straight	Ø130 x 180	WW
G130-4-WW	6W	E27	Straight	Ø130 x 180	WW
G130-7-WW	6W	E27	Straight	Ø130 x 180	WW
G130-15-WW	6W	E27	Straight	Ø130 x 180	WW

Ice Flower - 2700K | 360° Beam Angle

Supply Volts: 230VAC



Code	Wattage	Base	Filament Shape	Size (mm)	Colours
G95-ICE-WH	6W	E27	Straight	Ø95 x 138	WW
G95-ICE-Y	6W	E27	Straight	Ø95 x 138	WW
G125-ICE-WH	6W	E27	Straight	Ø125 x 176	WW
G125-ICE-Y	6W	E27	Straight	Ø125 x 176	WW

* Add base to code: E27 or B22

LED DECORATIVE LAMPS

Coloured G45 - 360° Beam Angle | Single Filament | 2 per Pack | Supply Volts: 230VAC

Code	Wattage	Base	Filament Shape	Size (mm)	Colours
AG45-1W-R/2	1W	B22	Straight	Ø45 x 74	Red
AG45-1W-GN/2	1W	B22	Straight	Ø45 x 74	Green
AG45-1W-BL/2	1W	B22	Straight	Ø45 x 74	Blue
AG45-1W-Y/2	1W	B22	Straight	Ø45 x 74	Yellow
AG45-1W-P/2	1W	B22	Straight	Ø45 x 74	Purple



AG45-1W-R AG45-1W-GN AG45-1W-BL AG45-1W-Y AG45-1W-P



G95-2W-R G95-2W-GN G95-2W-BL G95-2W-Y G95-2W-P

Coloured G95 - 360° Beam Angle | Single Filament | Supply Volts: 230VAC

Code	Wattage	Base	Filament Shape	Size (mm)	Colours
G95-2W-R	2W	E27	Straight	Ø95 x 140	Red
G95-2W-G	2W	E27	Straight	Ø95 x 140	Green
G95-2W-BL	2W	E27	Straight	Ø95 x 140	Blue
G95-2W-Y	2W	E27	Straight	Ø95 x 140	Yellow
G95-2W-P	2W	E27	Straight	Ø95 x 140	Purple

NEW

SUPER FINE FILAMENT EFFECT

Twisted DNA Filament Effect Lamp - 1800K | Supply Volts: 230VAC

Code	Wattage	Base	Filament Shape	Size (mm)	Colours
RN-DNA-G125-C	3.5W	E27	DNA	Ø125 x 164	WW
RN-DNA-G125-S	3.5W	E27	DNA	Ø125 x 164	WW
RN-DNA-G125-A	3.5W	E27	DNA	Ø125 x 164	WW

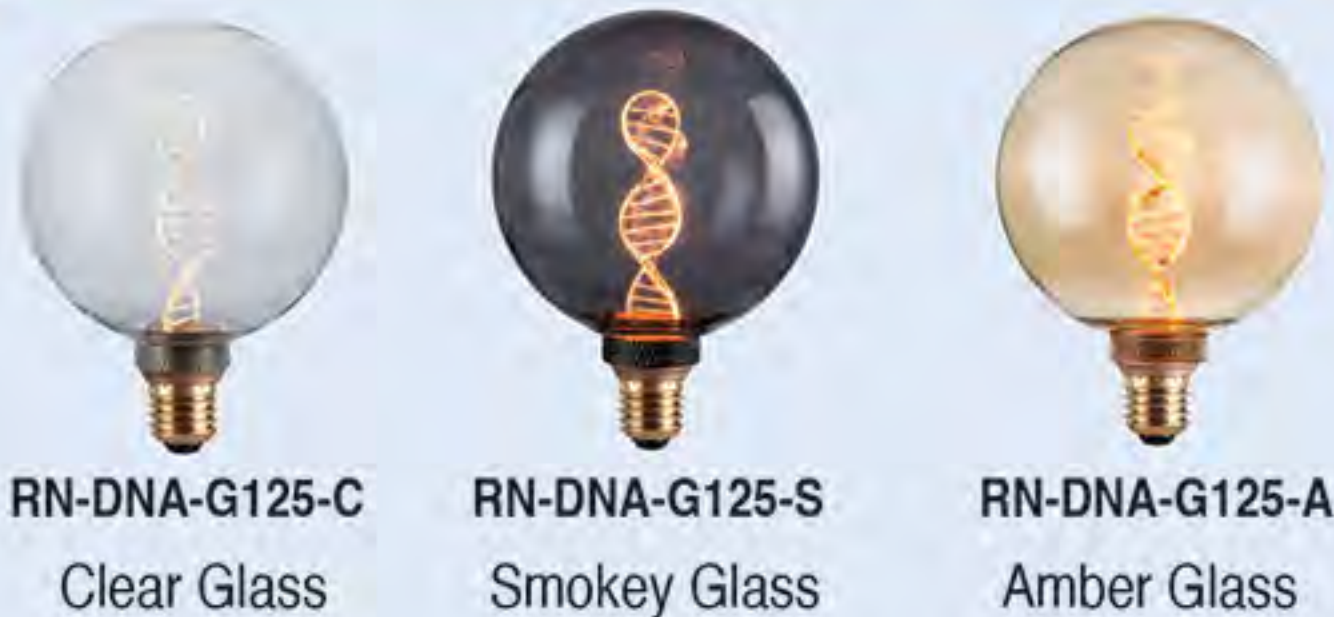

RN-DNA-G125-C Clear Glass RN-DNA-G125-S Smokey Glass RN-DNA-G125-A Amber Glass

Graphic Filament Effect Lamp - 1800K | Supply Volts: 230VAC

Code	Wattage	Base	Filament Shape	Size (mm)	Colours
RN-GRP-G125-WV	6W	E27	Straight	Ø125 x 172	WW
RN-GRP-G125-DOT	6W	E27	Straight	Ø125 x 172	WW
RN-GRP-G125-MET	3.5W	E27	Straight	Ø125 x 164	WW



RN-GRP-G125-WV RN-GRP-G125-DOT RN-GRP-G125-MET

Shaped Glass Filament Effect Lamp - 1800K | Supply Volts: 230VAC

Code	Wattage	Base	Filament Shape	Size (mm)	Colours
RN-I-CG200	4W	E27	Straight	Ø200 x 241	WW
RN-I-HR-G130-A	4W	E27	Straight	Ø130 x 178	WW
RN-I-VR-G130-A	4W	E27	Straight	Ø130 x 174	WW
RN-I-FEC-G130-C	4W	E27	Straight	Ø125 x 174	WW



RN-I-CG200 Amber Glass RN-I-HR-G130-A Amber Glass RN-I-VR-G130-A Amber Glass RN-I-FEC-G130-C Clear Glass

Plain Glass Filament Lamp - 1800K | Supply Volts: 230VAC

Code	Wattage	Base	Filament Shape	Size (mm)	Colours
RN-I-T60-A	4W	E27	Straight	Ø60 x 300	WW
RN-I-G95-A	4W	E27	Straight	Ø95 x 144	WW
RN-I-G125-A	4W	E27	Straight	Ø125 x 164	WW
RN-I-AP125-S	4W	E27	Straight	Ø125 x 163	WW



RN-I-T60-A Amber Glass RN-I-G95-A Amber Glass RN-I-G125-A Amber Glass RN-I-AP125-S Smokey Glass

LED U LAMPS

LED	FLUORESCENT	INCANDESCENT
3W →	7W →	35W →
5W →	11W →	50W →
7W →	15W →	70W →
9W →	19W →	90W →
12W →	25W →	120W →
16W →	33W →	160W →
20W →	38W →	200W →
30W →	60W →	300W →

- WW - 2700K
- CW - 4200K



LED 2U

Code E27	Code B22	Supply Volts	Wattage	Length	Lumens	*Add Colour to Code
LED2U-3W-E27-*	LED2U-3W-B22-*	230, 12, 24, 48	3W	105mm	240lm	WW / CW
LED2U-5W-E27-*	LED2U-5W-B22-*	12, 24, 48	5W	115mm	400lm	WW / CW

LED 3U

LED3U-5W-E27-*	LED3U-5W-B22-*	230	5W	135mm	400lm	WW / CW
LED3U-7W-E27-*	LED3U-7W-B22-*	230, 12, 24, 48	7W	145mm	560lm	WW / CW
LED3U-9W-E27-*	LED3U-9W-B22-*	230, 12, 24, 48	9W	145mm	720lm	WW / CW
LED3U-12W-E27-*	LED3U-12W-B22-*	230	12W	170mm	960lm	WW / CW
LED3U-16W-E27-*	LED3U-16W-B22-*	230	16W	175mm	1280lm	WW / CW

LED 4U

LED4U-20W-E27-*	LED4U-20W-B22-*	230	20W	175mm	1600lm	WW / CW
LED4U-30W-E27-*	LED4U-30W-B22-*	230	30W	255mm	2550lm	WW / CW

* Add DC Voltages to code: -12VDC, -24VDC, -48VDC

HIGH POWER U-LAMPS

Input Voltage: 90-265VAC | Beam Angle 320° | Colour Temp 6500K



Code	Wattage	Base	Lumens	Size
HP-2U-20W	20W	E27	1700lm	Ø46 x 194
HP-4U-30W	30W	E27	2550lm	Ø72 x 223
HP-4U-40W	40W	E27	3600lm	Ø72 x 240
HP-4U-50W	50W	E27 & E40	4200lm	Ø72 x 256
HP-5U-60W	60W	E27 & E40	5100lm	Ø88 x 265
HP-5U-70W	70W	E27 & E40	5900lm	Ø88 x 295
HP-8U-100W	100W	E40	9000lm	Ø125 x 310
HP-8U-120W	120W	E40	10200lm	Ø125 x 320

Lamps

LED CORN LIGHTS

High Power Lamps Supply Voltage: 100-250VAC Beam Angle: 360° PF>0.9



Code No Fan	Code Fixed Fan	Code Replaceable Fan	Watts	Lumen	Base	Size (mm)
FX-BL-20W-WW	-	HS-JN01-020-*	20W	1650lm	E27	Ø96x230
FX-BL-30W-WW	-	HS-JN01-030-*	30W	2500lm	E27	Ø96x250
FX-BL-40W-WW	-	HS-JN01-040-*	40W	3500lm	E40	Ø96x290
FX-BL-50W-CW	-	-	50W	4100lm	E40	Ø96x310
FX-BL-60W-WW	-	HS-JN01-060-*	60W	5800lm	E40	Ø96x340
FX-KBL-80W-CW	-	HS-JN01-075-*	75/80W	7200lm	E40	Ø117x350
FX-KBL-100W-*	HS-JN05-100-*	-	100W	9200lm	E40	Ø117x390
FX-KBL-120W-*	HS-JN05-120-*	-	120W	11000lm	E40	Ø117x430

*Add colour to code: ○ CW (Cool White) 5500-6000K, ○ WW (Warm White) 3000K.

For spare replacement fan use code: HS-JN01-FAN

LIGHTING

LED COMPACT LAMPS

<ul style="list-style-type: none"> ○ WW - 2700K ○ CW - 4200K 					
Code	LP-T48-2-0.6W	LP-T48-2-2W	LP-T48-2-4W	LP-T45-4-0.6W	LP-T45-4-1.4W
Wattage	0.6W	2W	4W	0.6W	1.4W
Base	E27	E27	E27	E27	E27
Lumens	45lm	150lm	300lm	45lm	105lm
Beam Angle	180°	180°	180°	180°	180°
*Add colour to code	CW	CW	CW	CW	CW

LED CORN

Supply Volts 230VAC								
<ul style="list-style-type: none"> ○ WW - 2700K ○ CW - 4200K ○ DL - 6000K 	Code	SDES-906-*-*	SDES-911-*-*	SDES-915-*-*	SDES-930-*	FX-GRL-4.5W-*	FX-GRL-12.5W-*	FX-GRL-18W-*
	Wattage	6W	11W	16W	30W	4.5W	12.5W	18W
	*Base	E27/B22	E27/B22	E27/B22	E27	E27	E27	E27
	Lumens	480lm	880lm	1280lm	3000lm	360-420lm	960-1050lm	1420-1500lm
	Size (mm)	Ø38 x 113	Ø41 x 114	Ø43 x 160	Ø82 x 225	Ø32 x 103	Ø61 x 146	Ø84 x 157
	*Add colour to code	CW / DL	CW / DL	CW / DL	CW / DL	WW / CW	WW / CW	WW

HP T-LAMPS

- WW - 2700K
- CW - 4200K
- DL - 6500K

3Year Warranty

Non-Dimmable T-Lamps | 110V Lamp has Over Voltage Protection. Only operates between 110-140VAC



Code	Wattage	*Add Base to Code	Lumens	Supply Voltage	Size (mm)	*Add Colour to Code
TP-DL-5W-*	5W	E27	470lm	170-265VAC	Ø50 x 100	WW / CW
TP-DL-5W-CW 110V	5W	E27	470lm	110VAC	Ø50 x 100	CW
TP-DL-10W-*	10W	E27	870lm	170-265VAC	Ø60 x 119	WW/CW/DL
TP-DL-10W-CW 110V	10W	E27	870lm	110VAC	Ø60 x 115	CW
TP-DL-15W-*	15W	E27	1350lm	170-265VAC	Ø70 x 130	WW/CW/DL
XH-T95-20W-*-*	20W	*E27 / *B22	1600lm	170-230VAC	Ø80 x 145	WW / CW
TP-DL-20W-CW 110V	20W	E27	1600lm	110VAC	Ø80 x 142	CW
XH-T95-30W-*-*	30W	*E27 / *B22	2400lm	170-265VAC	Ø115 x 202	WW / CW
XH-T110-40W-*-*	40W	*E27 / *B22	3600lm	170-265VAC	Ø120 x 200	WW / CW
XH-T149-60W-*	60W	E40	4800lm	170-265VAC	Ø160 x 280	WW/CW/DL
XH-T135-80W-*	80W	E40	7200lm	170-265VAC	Ø151 x 255	WW/CW/DL
XH-T150-100W-*	100W	E40	9000lm	170-265VAC	Ø148 x 260	WW/CW/DL
XH-T158-150W-*	150W	E40	12000lm	170-265VAC	Ø160 x 288	WW/CW/DL

- WW - 2700K
- CW - 4200K
- DL - 6500K



Dimmable T-Lamps

Code	Wattage	Base	Lumens	Supply Voltage	Size (mm)	*Add Colour to Code
DTP-DL-5W-*	5W	E27	300-350lm	230VAC	Ø58 x 144	WW / CW
DTP-DL-10W-*	8W	E27	650-700lm	230VAC	Ø68 x 165	WW / CW

Automatic Dim - Energy Saving mode or Regular Mode | Sensor Range 7m | Lamp will automatically dim down to save energy when no movement

L-BL-1001-40W	40W	E27 & E40	3500lm	100-240VAC	Ø100 x 218	DL(6500K)
----------------------	-----	-----------	--------	------------	------------	------------------

- DL - 6500K

3Year Warranty



High Power Lamps

Code	Wattage	Base	Lumens	Supply Voltage	Size (mm)	Colour Temp.
L-BL-0490	55W	E27	4200lm	85-265VAC	Ø100 x 218	DL(6500K)
L-BL-0494	65W	E40	5400lm	85-265VAC	Ø100 x 300	DL(6500K)
LES-ED120-80W	80W	E40	8800lm	100-240VAC	Ø120 x 285	DL(6500K)
LES-ED120-100W	100W	E40	11000lm	100-240VAC	Ø120 x 285	DL(6500K)

2-year warranty on all LED products & 1-year warranty on battery-operated products, unless specified. LED warranty void without surge protection. Refer to page 128.

HP T-LAMPS

○ DL - 6500K

**3Year
Warranty**



E27-E40 Adaptor



CRD
80/100W



Optional Reflector



HN-HB001
150/200W

High Power T-Lamps - Optional Reflector | Lamps supplied with E27-E40 Adaptor

Code	Wattage	Base	Lumens	Supply Voltage	Size (mm)	Colour Temp.
CRD-HP80W	80W	E27 & E40	7600lm	230VAC	Ø140 x 300	DL(6500K)
CRD-HP100W	100W	E27 & E40	9000lm	230VAC	Ø140 x 300	DL(6500K)
HN-HB001-150W	150W	E27 & E40	13500lm	230VAC	Ø160 x 325	DL(6500K)
HN-HB001-200W	200W	E27 & E40	18000lm	230VAC	Ø160 x 325	DL(6500K)

Accessories Code	Description
HN-HB001-REF	Optional Reflector for use with HN-HB001-100W / 200W
CRD-HP-REF	Optional Reflector for use with CRD-HP80W / 100W

○ DL - 6500K

**3Year
Warranty**



HBL-CNL
65W, 85W, 105W



HN-HB001
65/85/105W

High Power Lamps

Code	Wattage	Base	Lumens	Supply Voltage	Size (mm)	Colour Temp.
HBL-CNL-65W	65W	E40	5400lm	230VAC	Ø145 x 225	DL(6500K)
HBL-CNL-85W	85W	E40	7200lm	230VAC	Ø170 x 275	DL(6500K)
HBL-CNL-105W	100W	E40	9500lm	230VAC	Ø190 x 275	DL(6500K)

High Power Lamp c/w Reflector - 230VAC | 6500K

HN-HB001-65W	65W	E40	5525lm	230VAC	Ø345 x 110	DL(6500K)
HN-HB001-85W	85W	E40	7225lm	230VAC	Ø400 x 300	DL(6500K)
HN-HB001-105W	100W	E40	8500lm	230VAC	Ø420 x 330	DL(6500K)

○ DL - 6500K

**5Year
Warranty**

130
lm/w



Lens

Diffuser

High Power Industrial Lamps - E40 | 100 - 265VAC

Code	Wattage	Optic	Lumens	Size (mm)	Colour Temp.
RW-RS1-DD-65-DL	65W	Diffuser	8450lm	Ø200 x 275	DL(6500K)
RW-RS1-DD-100-DL	100W	Diffuser	13000lm	Ø200 x 275	DL(6500K)
RW-RS1-DD-150-DL	150W	Diffuser	19500lm	Ø200 x 275	DL(6500K)
RW-RS1-L-65-DL	65W	90° Lens	8450lm	Ø200 x 238	DL(6500K)
RW-RS1-L-100-DL	100W	90° Lens	13000lm	Ø200 x 238	DL(6500K)
RW-RS1-L-150-DL	150W	90° Lens	19500lm	Ø200 x 238	DL(6500K)



LS-GL-100W-DL

120° Adjustable Light Panel - IP20 Input Voltage: 220-240VAC | 6000K | Material: Die-Cast Aluminium + PC Beam Angle 120° | CRI>80 | Colour Temp 5500K | Suitable for Garage, warehouse and office

Code	Wattage	Base	Lumens	Size (mm)
LS-GL-60W-DL	60W	E27	6000lm	232 x 214 x 100
LS-GL-100W-DL	100W	E27	10000lm	266 x 266 x 112

LED MODULES IP67

**5Year
Warranty**



Input Voltage: 36VDC | 6063 Aluminium Alloy Material | Light transmittance is more than 95% | Standardized electrical interface, convenient to install | 6500K | Power Supply not Supplied.

Beam Angle:
A: 54° / 48°
B: 90° / 50°
C: 90°
D: 60°

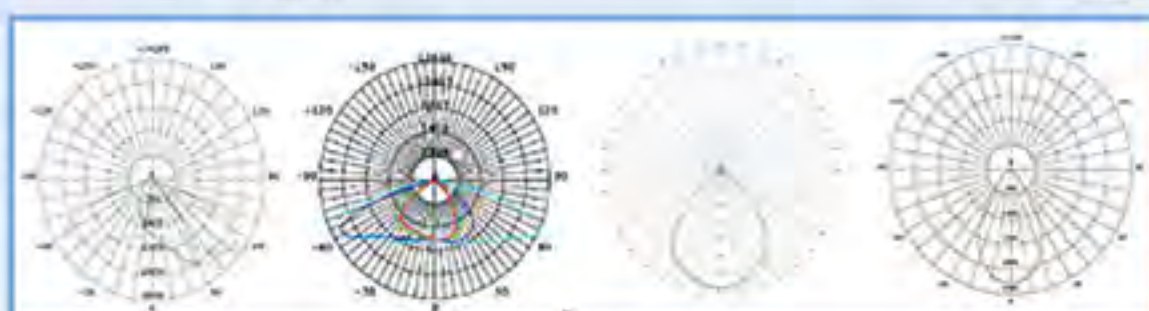

Optical Design

Code	Wattage	Lumens	Current	Beam Angle	Size (mm)
MS02A-50-A	50W	6500lm	1500mA	145° / 100°	300 x 76 x 54
MS02A-50-B	50W	6500lm	1500mA	150° / 70°	300 x 76 x 54
MS02A-50-C	50W	6500lm	1500mA	90°	300 x 76 x 54
MS02A-50-D	50W	6500lm	1500mA	40°	300 x 76 x 54

PAR LED LAMPS

○ WW - 2700K
○ CW - 4000K



KL-PAR38-18W*

HS-PAR38-18W

PAR 38 Anti Glare - Supply Voltage 220-240VAC

KL-PAR38-18W*	18W	1200-1300lm	E27	40°	WW / CW
---------------	-----	-------------	-----	-----	---------

PAR 38 Colour Lamp - Supply Voltage 220-240VAC

HS-PAR38-18W	18W	1200lm	E27	60°	●R / ●BL / ●Y
--------------	-----	--------	-----	-----	---------------

Dimmable PAR Lamps - 230VAC

○ WW - 2700K
○ CW - 4000K



PAR 20

PAR 30

PAR 38
Wide Angle

PAR 38
Narrow Angle

PAR 20 - Supply Voltage 220-240VAC | IP65

Lamp Code	Wattage	Lumens	Base	Beam Angle	*Add Colour to Code
DIM-PAR20-10W*	10W	830-890lm	E27	60°	WW / CW

PAR 30 - Supply Voltage 220-240VAC | IP65

DIM-PAR30-12W*	12W	930-1000lm	E27	120°	WW / CW
----------------	-----	------------	-----	------	---------

PAR 38 Narrow Angle - Supply Voltage 220-240VAC | IP65

LCM8106-60DIM*	18W	1440lm	E27	60°	WW / CW
----------------	-----	--------	-----	-----	---------

PAR 38 Wide Angle - Supply Voltage 220-240VAC | IP65

LCM8106-160DIM*	18W	1440lm	E27	160°	WW / CW
-----------------	-----	--------	-----	------	---------

LR20-10W01



LR20-04W01



LR30-LHA-B22



PAR 20 VARI FOCAL - Supply Voltage 110-240VAC | Colour Temperature 5000K | Variable Beam Angle

Code	Base	LED Qty/W	Total LED Watts	Lumen for CW	Lumen for WW	Beam Angle	Colour Temperature
LR20-04W01	E27	1 x 4W	4W	90-160lm	90-160lm	15-40°	5000K
LR20-10W01	E27	1 x 10W	10W	360-520lm	360-520lm	15-40°	5000K

Accessories

Code	Description
LR30-LHA-B22	Interchangeable adaptor from E27 to B22. For LR20 and LR30.

LR30-12W03



LR30-12W01



LHA-02



Special PAR30 - Supply Voltage 85-260VAC | Colour Temperature 5000K

Code	Base	LED Qty/W	Total LED Watts	Lumen for CW	Lumen for WW	Beam Angle	Colour Temperature
LR30-12W01	E27	3 x 4W	12W	± 600lm	± 600lm	45°	5000K
LR30-12W03	E27	3 x 4W	12W	± 600lm	± 600lm	15°	5000K

Lamps are supplied with E27 bases. The base can be changed to B22 with a lampholder adaptor.

Accessories

Code	Description
LHA-02	Interchangeable adaptor from E27 to B22. For LR20 and LR30.

○ WW - 2700K
○ CW - 4200K



PAR56 - 230VAC | IP20

Code	Base	LED Qty/W	Total LED Watts	Lumen for CW	Lumen for WW	Beam Angle	*Add Colour to Code
HS-PAR56-32*	E27	16 x 2W	32W	±2600lm	±2400lm	120°	WW / CW

LED PAR38 Plant Grow - IP65

Code	Base	Watts	Lumen
LED-PAR38-12W-PG	E27	12W	171lm

- 75% Red, 25% Blue
- The wave length for red is 662nm, for blue is 447nm



INFRARED PAR38

Mainly used in chicken farming.



Infrared Heat Lamp - 230VAC

Code	PAR38-IR-175W
Power	175W
Lamp Base	E27
Lamp Life	5000h



Heat Lamp Fitting

Code	HLF-01
Material	Bakelite
Size	Ø 145 x 180mm

LED LAMPS - 230VAC

Pygmy Lamps -2 Per Pack

<ul style="list-style-type: none"> ○ WW - 2700K ○ CW - 4200K 					
Code	SL-0.5W-E14/2	SL-2.5W-E14/2	LR-0.5W-E14-*/2	LR-0.5W-15D-*/2	LR-0.5W-15S-*/2
Wattage	0.5W	2.5W	0.5W	0.5W	0.5W
Base	E14	E14	E14	BA15D	BA15S
Lumens	15lm	80lm	80lm	30-40lm	30-40lm
Size (mm)	Ø27 x 56	Ø27 x 68	Ø18.5 x 45	Ø18.5 x 45	Ø18.5 x 45
Colour	WW	WW	CW	CW	CW
Supply Voltage: 230VAC			*Add Voltage to Code: 12VAC/DC, 24VAC/DC, 110VAC, 230VAC		

Lamps

NEW					
Code	LR-1W-E14 230VAC/2	LR-1W-15S 230VAC/2	LR-1W-E14 12V/2	LR-1W-15S 12V/2	LR-1W-15D 12V/2
Wattage	1W	1W	1W	1W	1W
Base	E14	BA15S	E14	BA15S	BA15D
Lumens	80lm	80lm	80lm	80lm	80lm
Size (mm)	18,5 x 45mm	18,5 x 45mm	18,5 x 45mm	18,5 x 45mm	18,5 x 45mm
Colour	4000K	4000K	4000K	4000K	4000K

Pygmy Lamps Colour

Code	LED-E14-*/*	P19S-E2701*-*	LM-LED*-* /2
Wattage	2.7W	1.3W	2W
Base	E14	E27	BA15D
Lumens	300lm	117lm	180lm
Size (mm)	Ø31 x 79	Ø37 x 65	Ø22 x 54
Volts	*Add Voltage to Code: 12VAC/DC, 24VAC/DC, 110VAC, 230VAC		*Add Voltage to Code: 12VDC, 24VDC, 110VAC, 230VAC





















*Add colour to code: ○ W (White), ● R (Red), ● GN (Green), ● BL (Blue), ● Y (Yellow)

NEW



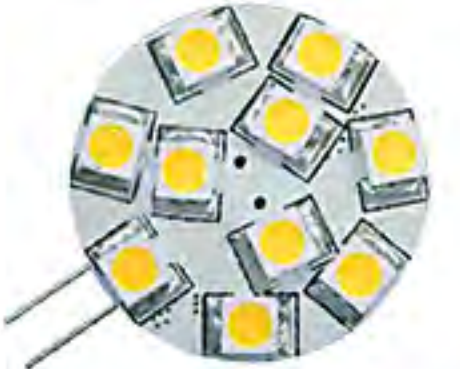

PYGMY - INCANDESCENT

	Fridge	Oven 300°C	Oven 300°C	Oven 300°C	Oven 300°C
Code	FPL-15W-E14	OPL-15W-E14	OPL-25W-E14	OPL-40W-E14	OPL-40W-E27
Wattage	15W	15W	25W	40W	40W
Base	E14	E14	E14	E14	E27
Lumens	150lm	150lm	250lm	400lm	400lm
Size(mm)	Ø26 x 56	Ø25 x 55	Ø25 x 55	Ø75 x 45	Ø45 x 73
Colour	2700K	2700K	2700K	2700K	2700K

LED LAMPS

G9 LED Lamps 2 per pack Supply Volts 230VAC ○ WW - 2700K ○ CW - 4200K	2 per pack 		2 per pack 		2 per pack 		2 per pack Dimmable 							
	Code	G9-2W-*/2		G9-3W-*/2		SG9-5W-*/2		DIM-G9-3W-WW/2						
Watts	2W		3W		5W		3W							
Lumen	200lm		320lm		380lm		300lm							
Size (mm)	Ø16 x 48		Ø23 x 63		Ø16 x 60		Ø19 x 55							
*Add colour to code	WW / CW		WW / CW		WW / CW		WW							
JC LED Lamps 2 / blister pack Supply Volts 12V ○ WW - 2700K ○ CW - 4200K	2 / blister pack 		2 / blister pack 		2 / blister pack 		2 / blister pack Dimmable 							
	Code	JC-0.6W-*/2		JC-1.3W-*/2		JC-1.5W-*/2		DIM-JC-1.5W-*/2						
Watts	0.6W		1.3W		1.5W		1.5W							
Lumen	40lm		80lm		100lm		120lm							
Size (mm)	Ø10 x 33		Ø12 x 31		Ø14 x 31.5		Ø12 x 31							
*Add colour to code	WW / CW		WW / CW		WW / CW		WW / CW							
G4 LED Lamps 2 / blister pack 2 / blister pack 2 / blister pack 2 / blister pack 2 / blister pack 1 / blister pack 2 per pack ○ WW - 2700K ○ CW - 4200K	2 / blister pack  12V		2 / blister pack  12V		2 / blister pack  12V		2 / blister pack  230V		2 / blister pack  12V		1 / blister pack  12V		2 per pack Dimmable 	
	Code	G4-1W-*/2		G4-2.3W-*/2		G4-3W-*/2		G4-2.3W-*/2 230		SHL-G4-1.5W-*/2		SHL-G4-3W-*		DIM-G4-2W-*/2
Power	1W		2.3W		3W		2.3W		1.5W		3W		2W	
Lumen	50lm		210lm		270lm		210lm		160lm		230lm		200lm	
Size (mm)	Ø10 x 35		Ø16 x 44		Ø16 x 44		Ø16 x 44		Ø10 x 36		Ø16 x 45		Ø16 x 44	
*Add colour to code	WW / CW		WW / CW		WW / CW		WW / CW		WW / CW		WW / CW		WW / CW	
G4 LED Lamps Side Pins Bottom Pins Supply Volts 8-30VAC ○ WW - 2700K ○ CW - 4200K	Side Pins 			Bottom Pins 			Bottom Pins 			G12 LED Lamps 12V 		230V 		
	Code	EL-G4-1/2			EL-G4-2/2			EL-G4-4/2			HL-G12-10W-*		HL-G12-10W-*/230	
Power	1.2W			1.5W			1.8W			10W		10W		
Lumen	70lm			100lm			120lm			1200lm		1200lm		
Size (mm)	Ø23			Ø28			Ø32			Ø26 x 118		Ø26 x 118		
*Add colour to code	CW (4000K)			CW (4000K)			CW (4000K)			WW / CW		WW / CW		

LED RETROFIT R7s LAMPS

○ DL - 6000K	R7s Lamps				
	R7s Lamps - 360° Beam Angle				
		NEW 		NEW 	NEW 
Code	R7S-LED-15W	LED-R7S-5W	LED-R7S-8W	LED-R7S-10W	LED-R7S-15W
Wattage	15W	5W	8W	10W	15W
Base	R7s	R7s	R7s	R7s	R7s
Lumens	1450lm	500lm	900lm	1100lm	1650lm
Size (mm)	189	Ø13 x 78	Ø13 x 118	Ø13 x 118	Ø13 x 118

2-year warranty on all LED products & 1-year warranty on battery-operated products, unless specified.
LED warranty void without surge protection. Refer to page 128.

LED PL LAMPS

Supply Volts: 220-240VAC

- WW - 2700K
- CW - 4200K
- DL - 6000K



Code	FBPL-6DW-*	FBPL-8DW-*	FBPL-10DW-*	LEDPL-5W-*	LEDPL-10W-*	LEDPL-12W-*	LEDPL-15W-*
Wattage	6W	8W	10W	5W	10.5W	12W	15W
Lumen	560lm	750lm	940lm	425lm	900lm	1100lm	1400lm
Base	G24d	G24d	G24d	G24d	G24d	G24d	G24d
Size (mm)	Ø35 x L145	Ø35 x L166	Ø35 x L181	Ø44 x 98	Ø34 x 150	Ø35 x 140	Ø35 x 140
*Add colour to code	6000K	6000K	6000K	WW / CW / DL	WW / CW / DL	CW / DL	CW / DL

*Add - 'EM' to code for Emergency PL Lamp. c/w driver. 3 Hr backup. eg FBPL-10DW-EM

LED PLL LAMPS

- WW - 2700K
- CW - 4200K

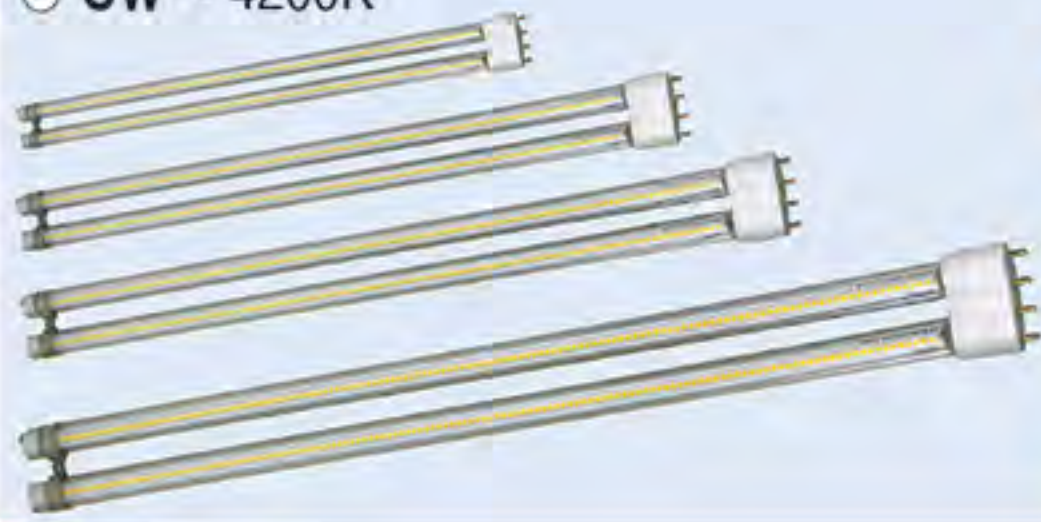

LED PLL Lamp Series

Code	PLL-226-8W-*	PLL-321-16W-*	PLL-415-20W-*	PLL-541-25W-*
Watts	8W	16W	20W	25W
Voltage	AC100-240V	AC100-240V	AC100-240V	AC100-240V
Lumen	675lm	1380lm	1700lm	2120lm
Size (mm)	Ø41.4 x L210.1	Ø41.4 x L404.1	Ø41.4 x L526.1	Ø41.4 x L526.1
*Add colour to code	WW / CW	WW / CW	WW / CW	WW / CW

LED RETROFIT MODULES



CCT and Power Adjustable Magnetic LED Module - Input Voltage: 230VAC | Power Adjustable | CCT Adjustable 3000-6000K

Code	Wattage	Lumens	Size (mm)	* Add Colour to code
CP-FD-12/18/24W-CCT	12/18/24W	100lm/W	Ø170	Colour Temp Adjustable
CP-FD-24/30/36W-CCT	24/30/36W	100lm/W	Ø223	Colour Temp Adjustable

- WW - 2700K
- CW - 4200K
- DL - 6000K



Magnetic LED Module for Bulkheads - Input Voltage: 230VAC

Code	Power	Lumens	Size (mm)	* Add Colour to code
CP-FD-9W-*	9W	680lm	Ø130 x 24	WW / CW / DL
CP-FD-18W-*	18W	1350lm	Ø170 x 24	WW / CW / DL

- CW - 4200K
- DL - 6500K



Universal LED Module - Input Voltage: 230VAC | Simple Retrofit Solution | 160° Beam Angle | Driver less | 3 Mounting Options; Magnetic, Screws, Double sides heat conductive tape (Tape Included)

Code	Wattage	Lumens	Size (mm)	* Add Colour to code
H-HB-12W-*	12W	1150lm	80 x 80	CW / DL
H-HB-24W-*	24W	2300lm	80 x 160	CW / DL
H-HB-36W-*	36W	3500lm	140 x 140	CW / DL
H-HB-45W-*	45W	4300lm	170 x 170	CW / DL



EMG LED Magnetic Module - Input Voltage: 100-240VAC | Wired Connection | Charge Time: 13hrs | EMG time 3hrs | 3.6Ah Battery

Code	Power	Lumens	Size (mm)	* Add Colour to code
EMG-CL-18W-DL	18W	1800lm Normal 400lm EMG	Ø130 x 24	DL
EMG-CL-24W-DL	24W	2400lm Normal 400lm EMG	Ø170 x 24	DL



EMG LED 2D Type - Input Voltage: 230VAC | EMG Time: 3-4hrs | Base: GR8

Code	Wattage	Lumens	Size (mm)	* Add Colour to code
2D-LEMG-16W-*	16W	1700lm	200x200x31	WW / CW

SMART CONTROLLABLE LED LAMPS



Dimmable and Colour Change Lamps - c/w 24 Key Remote

Code	Colour	Base	Watts	Volts
HS-MR16-RGB 12V	Multi Colour Changing	GU5.3 (MR16)	3W	12VAC/DC
HS-GU10-RGB/W	Multi Colour Changing + White	GU10	5W	110-265VAC



Bluetooth or WIFI LED Speaker Lamps - Input Voltage: 100-240VAC | E27 base | True Wireless Stereo | Smart Device Control | App for IOS & Android



Code	LMS-20	LMS-40
Description	Bluetooth LED Speaker - Master & Slave	WIFI Speaker - Single Speaker Multiple speakers can be grouped in app for True Stereo
LED Watts	9W	7W
LED Lumens	600lm	450lm
Colour Temp	2700K - Warm White	2700K - Warm White
Light Beam Angle	120°	120°
Audio Power	15 Watts (Max.) @ 4ohm	15 Watts (Max.) @ 4ohm
Speaker	2" Full Range	2" Full Range
Maximum SPL	90dB (93dB for Master Speaker + Slave Speaker)	90dB
Communication Type	Bluetooth V4.0, Dual Mode	WiFi 2.402 - 2.480 GHz

Adjustable Colour Temperature LED Lamps - Flick Switch off/on to change from one colour temperature to the next. Supply Volts: 220-240VAC

Code	Wattage	Base	Lumen	Beam Angle
CTA-A60-9W-E27	9W	E27	750lm	180°
CTA-A60-12W-E27	12W	E27	900lm	180°

Adjustable: 3000K - Warm White ; 4200K - Cool White ; 6500K - Daylight



FLAME SIMULATION LED LAMP

Input Voltage: 85-265VAC | Dynamic Moving Flame | Static On & Flame Effect Controlled by Switch

Code	Wattage	Lumens	Colour Temp	Base	Dimensions
LED-FLAME-E27	5W	250-499lm	1300K/1800K	E27	Ø80 x 134mm



SMART CONTROLLABLE LED LAMPS



ZYZ-LB-6WR Kit

Note: The ZYZ-LB-6WBB lamps are only compatible with the ZYZ-LB-6WRR remote.

Colour Temperature Adjustable
Daylight to Warm White
and Dimmable



Remote Controlled Lamps - Colour temperature adjustment & dimmable

Supply voltage: 85-265VAC | Lamps are dimmable from 0-100%. Colour Temp can be set from warm white to daylight (2700K-7000K) | Night light function, lamps can be controlled individually or in a group.

Code	Description
ZYZ-LB-6WR	Starter kit including two ZYZ-LB-6WBB lamps and one ZYZ-LB-6WRR remote control.
ZYZ-LB-6WBB	6W LED lamp, dimmable and colour temperature adjustable. 510-560lm: Dependant on the colour temperature. Can be paired with 4 remotes. Can be added to the kit. No limit of number of lamps per Remote Control.
ZYZ-LB-6WRR	Remote control. Functions: ON/OFF, dimmer and colour temperature adjustment. Can control individual lamps or groups of lamps depending on setup. Can be paired with an unlimited amount of lamps.

IR Adjustable Colour Temperature LED Lamp

Supply Volts: 220-240VAC



Code	Description	Lamp Wattage	Lumen	Lamp Colour	Size (mm)
1201RGBW	IR controlled LED lamp	7W	580lm	RGB + 2700-6500k	Ø68 x 119

Lamp Settings

1201RGBW

WiFi Adjustable Colour Temperature LED Lamps

Supply Volts: 220-240VAC





Code	Description	Lamp Wattage	Lumen	Lamp Colour	Size (mm)
1201RGBW-WF	WiFi and IR controlled LED lamp	7W	470lm	RGB + 2700-6500K	68 x 119
1203RGBW-2S-WF	WiFi and IR controlled LED lamp with Bluetooth speaker	12W	650lm	RGB + 2700-6500K	73 x 132



1203RGBW-2S-WF

- Lamps are grouped by Room and can be controlled as groups or individually
- Easily selectable moods for different occasions
- Manually selectable single colours and preset colour changing programs
- Manually adjustable colour temperature and brightness
- Programmable time delays and alarms

ENERGY SAVING LAMPS & HOLDERS

Code	Wattage	Base	Length	Base Code
 PLE-7-CW	7W	2G7	122mm	BCF-2G7
PLE-9-CW	9W	2G7	152mm	BCF-2G7
PLE-11-CW	11W	2G7	222mm	BCF-2G7
*Add to code: ○ WW (Warm White, 2700K), ○ CW (Cool White, 4000K)				
 NB5025-18-CW	18W	2G11	227mm	BCF-2G11
NB5025-24-CW	24W	2G11	322mm	BCF-2G11
NB5025-36-CW	36W	2G11	417mm	BCF-2G11
NB5025-55-CW	55W	2G11	542mm	BCF-2G11
*Add to code: ○ WW (Warm White, 2700K), ○ CW (Cool White, 4000K), ○ D (Daylight, 6500K)				
 2D-16-CW	16W	GR8	139mm	BCF-GR8
2D-16-4P-CW (4 Pin)	16W	GR10q	139mm	BCF-GR10q
2D-21-CW (2 Pin)	21W	GR8	139mm	BCF-GR8
2D-28-CW (2 Pin)	28W	GR8	202mm	BCF-GR8
2D-28-4P-CW (4 Pin)	28W	GR10q	202mm	BCF-G10q
*Add to code: ○ WW (Warm White, 2700K), ○ CW (Cool White, 4000K)				

FLUORESCENT LAMPS

T5 Lamps						T8 Lamps					
Code	Colour Temp.	Type	Length	Watts	Lumen	Code	Colour Temp.	Type	Length	Watts	Lumen
 FLT5-6-CW	4000K	T5	225mm	6W	240lm	FLT8-10-CW	4000K	T8	1FT	10W	650lm
FLT5-8-CW	4000K	T5	300mm	8W	380lm	FLT8-15-DL	6500K	T8	450mm	15W	900lm
FLT5-13-CW	4000K	T5	517mm	13W	1010lm	FLT8-18-CW	4000K	T8	2FT	18W	1100lm
FLT5-14-CW	4000K	T5	563mm	14W	1200lm	FLT8-18-DL	6500K	T8	2FT	18W	1100lm
FLT5-14-DL	6500K	T5	563mm	14W	1200lm	FLT8-18-WW	2700K	T8	2FT	18W	1100lm
FLT5-21-CW	4000K	T5	863mm	21W	1870lm	FLT8-30-CW	4000K	T8	3FT	30W	2350lm
FLT5-28-CW	4000K	T5	1163mm	28W	2600lm	FLT8-36-CW	4000K	T8	4FT	36W	3350lm
FLT5-28-0-CW (Osram)	4000K	T5	1163mm	28W	2600lm	FLT8-36-DL-PH (Phillips)	6500K	T8	4FT	36W	3350lm
FLT5-28-DL	6500K	T5	1163mm	28W	2600lm	FLT8-58-CW	-	T8	5FT	58W	5200lm
FLT5-32-CW	4000K	T5	1210mm	32W	3300lm	*Add colour temp. to code: SNW (Snow White - 12000K), WW (Warm White - 2700K), CW (Cool White - 4000K), DL (Daylight - 6500K), SW (Skywhite - 8000K)					
FLT5-35-CW	4000K	T5	1449mm	35W	3135lm	T8 Coloured Lamps					
FLT5-35-DL	6500K	T5	1449mm	35W	3135lm	FLT8-36-CW	Y	T8	4FT	36W	2800lm
FLT5-49-CW	4000K	T5	1449mm	49W	4000lm	FLT8-58-CW	R, Y, G	T8	5FT	58W	4100lm
FLT5-54-CW	4000K	T5	1149mm	54W	4200lm	T8 Triphosphour Lamps					
FLT5-54-CDL	6500K	T5	1149mm	54W	4200lm	FLT8-18-WW-TRI	2700K	T8	2FT	18W	1100lm
FLT5-80-CW	4000K	T5	1449mm	80W	7000lm	FLT8-36-WW-TRI	2700K	T8	4FT	36W	2800lm
FLT5-80-SW	8000K	T5	1449mm	80W	6500lm	FLT8-58-WW-TRI	2700K	T8	5FT	58W	4800lm
Black Ultra Violet Lamps - 3000h life (Osram Lamps)						T8 Energy Saving Lamps					
Code	Base	Type	Length	Watts	Lumen	FLT8-ES23W-DL	6500K	T8	5FT	23W	1900lm
FLT5-6UV	G5	T5	225mm	6W	-	FLT8-ES37W-DL	6500K	T8	5FT	37W	3215lm
FLT5-8UV	G5	T5	300mm	8W	-	c/w special starter Only for use with magnetic switchgear					
FLT8-18UV	G13	T8	2FT	18W	-	T12 Lamps					
FLT8-36UV	G13	T8	4FT	36W	-	FLT12-75-CW	4000K	T12	8FT	75W	6600lm
Butcher Lamps - (Osram Lamps)											
L30W/76	G13	T8	3FT	30W	1300lm						
L36W/76	G13	T8	4FT	36W	1800lm						
L58W/76	G13	T8	5FT	58W	2850lm						

BLACK LIGHTS (UV LAMPS)

Energy Saving Black Lights - E27		
Code	Wattage	Size (mm)
UV2U-11	11W	165 x Ø 45
UV3U-15	15W	140 x Ø 50
UV3U-20	20W	155 x Ø 50
UV3U-25	25W	170 x Ø 50
PL Lamps		
Code	Wattage	Base
UVPL-9	9W	G23
UVPL-13	13W	G23
UVPLC-13	13W	G24d1
UVPLC-18	18W	G24d2
UVPLC-26	26W	G24d3

For UV LED Floodlight see page 26

2-year warranty on all LED products & 1-year warranty on battery-operated products, unless specified.
LED warranty void without surge protection. Refer to page 128.

METAL HALIDE LAMPS

	Double Ended		G12 Single Ended			Tubular	
Code	HQI-TS-70W	HQI-TS-150W	HCI-T-35W	HCI-T-70W	HCI-T-150W	HQI-T-250W	HQI-T-400W
Power	70W	150W	35W	70W	150W	250W	400W
Current	1A	1.80A	0.5A	1.0A	1.2A	3.0A	4.1A
Finish	Clear	Clear	Clear	Clear	Clear	Clear	Clear
Lamp base	RX7s	RX7s	G12	G12	G12	E40	E40
Lumen	5800lm	13000lm	3400lm	6800lm	10500lm	20000lm	36000lm
Colour Temp.	Natural Daylight 4200K		Natural Daylight 4200K			Natural Daylight 4200K	
	Elliptical			1000W		Double Ended	
Code	HQI-E-150W	HQI-E-250W	HQI-E-400W	HQI-T-1000W	HQI-T-2000W	HQI-TS-1000	HQI-TS-2000
Power	150W	250W	400W	1000W	2000W	1000W	2000W
Current	1.8A	2.1A	3.7A	9.7A	10.3A	8.6A	11.3A
Finish	Coated	Coated	Coated	Clear	Clear	Clear	Clear
Lamp base	E27	E40	E40	E40	E40	X528	X528
Lumen	12100lm	21500lm	40000lm	90000lm	220000lm	85000lm	230000lm
Colour Temp.	4200K	4200K	4200K	4400K	4200K	7250K	6100K

HIGH PRESSURE SODIUM LAMPS

	Tubular				
Code	NAV-T-70W	NAV-T-150W	NAV-T-250W	NAV-T-400W	NAV-T-1000W
Power	70W	150W	250W	400W	1000W
Current	1A	1.80A	3A	4.50A	10.6A
Finish	Clear	Clear	Clear	Clear	Clear
Lamp base	E27	E40	E40	E40	E40
Lumen	6600lm	17500lm	33200lm	56500lm	130000lm
	Elliptical				Internal Ignitor
Code	NAV-E-70W	NAV-E-150W	NAV-E-250W	NAV-E-400W	NAV-E-70W-I
Power	70W	150W	250W	400W	70W
Current	1A	1.80A	3A	4.40A	0.98A
Finish	Coated	Coated	Coated	Coated	Coated
Lamp base	E27	E40	E40	E40	E27
Lumen	6300lm	17000lm	31600lm	56500lm	5800lm

MERCURY VAPOUR LAMPS

Elliptical				
				
Code	HQL-80W	HQL-125W	HQL-250W	HQL-400W
Power	80W	125W	250W	400W
Current	0.80A	1.2A	2.1A	3.2A
Finish	Coated	Coated	Coated	Coated
Lamp base	E27	E27	E40	E40
Lumen	4000lm	6800lm	14000lm	24000lm

MERCURY BLENDED LAMPS

Elliptical			
			
Code	HWL-160	HWL-250	HWL-500
Power	160W	250W	500W
Current	0.80A	1.20A	2.40A
Finish	Coated	Coated	Coated
Lamp base	E27	E40	E40
Lumen	3100lm	5600lm	14000lm

HID LAMPS - ACDC

Watts	Metal Halide (MH) Code				High Pressure Sodium (HPS) Code		
	G12	Rx7s	Tubular	Elliptical	ST (Rx7s)	Tubular	Elliptical
	50W	G12-50-230VAC	-	-	-	-	-
70W	G12-70 230VAC	MD-70	-	MTE-70-E27	ST-70	SD-70-E27 SD-70I-E27†	-
100W	-	-	-	MTE-100-E27	-	SD-100-*	-
150W	G12-150 230VAC	MD-150	-	MTE-150-E27	ST-150	SD-150-E27	SE-150-E40
250W	-	-	MT-250-E40	MTE-250-E40	-	SD-250-E40	SE-250-E40
400W	-	-	MT-400-E40	MTE-400-E40	-	SD-400-E40	SE-400-E40
1000W	-	-	MT-1000-E40	MTE-1000-E40	-	SD-1000-E40	SE-1000-E40

*Add base to code: E27 or E40
†High pressure sodium with internal igniter

Colour							
150W	-	MD-150-*	-	-	-	-	-
400W	-	-	JLZ400W-BL	-	-	-	-

* Add colour to code: ● BL (Blue), ● GN (Green)

Mercury Vapour

	QE-80	80W	3240lm	E27
	QE-125	125W	5512.5lm	E27
	QE-250	250W	11025lm	E40
	QE-400	400W	21000lm	E40

Mercury Vapour Blended

	QB-160	160W	3100lm	E27
	QB-250	250W	5600lm	E40
	QB-500	500W	14000lm	E40

MD-(HQL-TS); MT-(HQL-T); MTE-(HQL); SD-(NAV-TS); SE-(NAVE); QE-(HQL); QB-(Mercury Vapour blended lamps)
Expected lamp life 5000hrs; Lamps to be used with relevant control gear.

LED FLOODLIGHTS

2 Year Warranty



Optional

LED Economical Floodlights - IP65 | Supply Voltage: 220-240VAC | Beam Angle: 120° | With 3 x MOV's | SMD Chipsets



Code	Code With Day/Night Sensor	Wattage	Lumens	Size (mm)
FL-10W-*	DNFL-10W-CW	10W	800lm	95 x 85 x 25
FL-20W-*	DNFL-20W-CW	20W	1600lm	120 x 100 x 30
FL-30W-*	DNFL-30W-CW	30W	2400lm	150 x 120 x 30
FL-50W-*	DNFL-50W-CW	50W	4000lm	200 x 150 x 30
FL-100W-*	DNFL-100W-CW	100W	8000lm	250 x 180 x 30
FL-150W-CW	DNFL-150W-CW	150W	12000lm	270 x 210 x 34
NEW FL-200W-CW	NEW DNFL-200W-CW	200W	16000lm	250 x 300 x 40

*Add colour to code: ○ **WW** (Warm White) 3000K, ○ **CW** (Cool White) 5500-6000K

NEW FL-400W-*	-	400W	32000lm	490 x 370 x 50
NEW FL-500W-DL	-	500W	42500lm	695 x 320 x 40

*Add colour to code: ○ **CW** (Cool White) 4200K, ○ **DL** (Daylight) 6000K

NEW **3 Year Warranty**



LED BK02 Low Profile Floodlights - IP65 | Supply Voltage: 180-265VAC | Beam Angle: 90° | Colour Temp: 6000K | CRI > 80 | 30 000hrs | Surge Protection: 10-20W 2kV, 20-100W 4kV, 150W 6kV, 200W 8kV | Aluminium Body

Code	Wattage	Lumens	Size (mm)
BK02-10W-*	10W	1000lm	107 x 84 x 16
BK02-20W-*	20W	2000lm	101 x 141 x 18
BK02-30W-*	30W	3000lm	128 x 177 x 19
BK02-50W-*	50W	5000lm	164 x 222 x 19
BK02-100W-*	100W	10000lm	215 x 291 x 19
BK02-150W-*	150W	15000lm	231 x 337 x 26
BK02-200W-*	200W	20000lm	281 x 393 x 38

*Add colour to code: ○ **WW** (Warm White) 3000K, ○ **DL** (Daylight) 6000K

NEW **5 Year Warranty**



LED IK02 Low Profile Floodlights - IP65 | Supply Voltage: 180-290VAC | Beam Angle: 90° | Colour Temp: 6000K | CRI > 80 | 50 000hrs | 5kV Surge Protection | Aluminium Body

Code	Wattage	Lumens	Size (mm)
IK02-2-100W-DL	100W	11000lm	236 x 203 x 26
IK02-2-150W-DL	150W	16500lm	276 x 231 x 30
IK02-2-200W-DL	200W	22000lm	266 x 312 x 31
IK02-2-400W-DL	400W	44000lm	440 x 590 x 20

5 Year Warranty



Sky 2.0 Floodlights - IP65 | Input Voltage: 230VAC | Driver on Board | Beam Angle: 90° | Removable cable entry for easy installation | Cable not supplied | SMD Chipset

Code	Wattage	Lumens	Size (mm)
YT-NP-FL16-10W-*	10W	900lm	90 x 65 x 45
YT-NP-FL16-20W-*	20W	1800lm	100 x 70 x 45
YT-NP-FL16-30W-*	30W	2700lm	136 x 95 x 45
YT-NP-FL16-50W-*	50W	4500lm	180 x 126 x 37
YT-NP-FL16-100W-*	100W	9000lm	210 x 147 x 37
NEW YT-NP-FL16-150W-*	150W	13500lm	231 x 337 x 38
NEW YT-NP-FL16-200W-*	200W	18000lm	281 x 393 x 38

*Add Colour to Code: ○ **WW** (Warm White) 3000K, ○ **CW** (Cool White) 5500-6000K

LED SPORT FLOODLIGHTS

5 Year Warranty



LED Stadia Floodlight - IP66 | Input Voltage: 100-277VAC | 140lm/W | RA80 | PF > 0.9 | Beam Angles 30° / 60° / 90° / 80° x 140° | Colour Temperature: 6000K | Ideal for Highmast lighting & Sport facilities

Code	Wattage	Lumens	Size (mm)
YT-NP-FL07-75W-*	75W	10125lm	365 x 310 x 60
YT-NP-FL07-100W-*	100W	13500lm	365 x 310 x 60
YT-NP-FL07-150W-*	150W	20250lm	365 x 365 x 60
YT-NP-FL07-200W-*	200W	27000lm	365 x 420 x 60
YT-NP-FL07-300W-*	300W	40500lm	387 x 590 x 63
YT-NP-FL07-400W-*	400W	54000lm	387 x 590 x 63

* Add Beam Angle to Code: **N**(30°), **M**(60°), **W**(90°), **MW**(80° x 140°). Only Stocking **W**(90°) other Beam Angles on Request only.

NEW



G2 Stadium Floodlights - IP66 | Input Voltage: 100-277VAC | 5500K | CRI >70 | 30°/45°/80° (150lm/W) | 15° (130lm/W) | c/w 10kV SPD | Operating Temp.: -40°C to 50°C | Remote Gear | Glare Control Lens | Applications: Stadiums, Arenas, Golf Courses, Courts | Available in 15°, 30°, 45°, 80° Beam Angles

Code	Wattage	Lumens	Size (mm)
ST-RSL-500W-*	500W	75 000lm	Ø410 x 236
ST-RSL-600W-*	600W	90 000lm	Ø410 x 236
ST-RSL-800W-*	800W	120 000lm	Ø510 x 236
ST-RSL-1000W-*	1000W	150 000lm	Ø510 x 236
ST-RSL-1200W-*	1200W	180 000lm	Ø510 x 236

* Add Beam Angle to Code: **15** (15°), **30** (30°), **45** (45°), **80** (80°)

5 Year Warranty

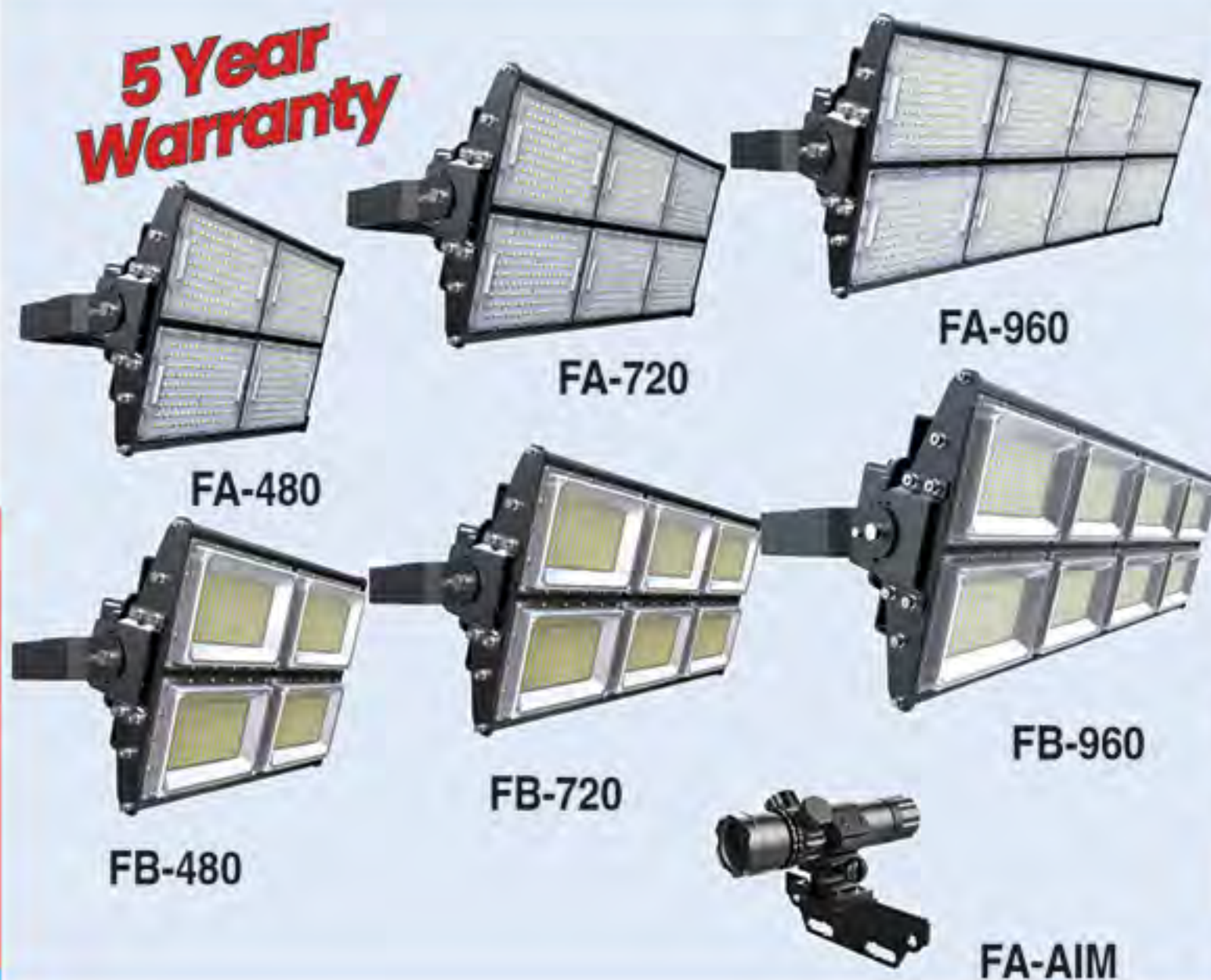

LED Stadium Floodlights - IP65 | Input Voltage: 100-277VAC | Phillips LumiLEDs | Meanwell Driver | Colour Temp: 5500K | Ideal for Stadium Lighting

Code	Wattage	Lumens	Beam Angle	Size (mm)
FA-480-30	480W	52 200lm	30°	630 x 500 x 285
FA-720-30	720W	82 800lm	30°	885 x 500 x 285
FA-960-30	960W	110 400lm	30°	1145 x 500 x 285
FA-480-60X100	480W	52 200lm	60° x 100°	630 x 500 x 285
FA-720-60X100	720W	82 800lm	60° x 100°	885 x 500 x 285
FA-960-60X100	960W	110 400lm	60° x 100°	1145 x 500 x 285
FB-480-120	480W	60 000lm	120°	630 x 500 x 285
FB-720-120	720W	90 000lm	120°	885 x 500 x 285
FB-960-120	960W	120 000lm	120°	1145 x 500 x 285

Accessories

Code	Description
FA-AIM	Laser Aiming device for LED Floodlight

LED MODULAR FLOODLIGHTS

5 Year Warranty



LED Adjustable Floodlights - IP65 | Input Voltage: 100-277VAC | Colour Temp: 6500K | Modular and adjustable | Suitable for Sports Fields, Warehouses, Gymnasiums, Workshops, Gas Stations, Toll Stations, Parking Areas, etc.

Code	Wattage	Lumens	Size (mm)
HBB-HD-C1	50W	7000lm	310 x 85 x 120
HBB-HD-C2	100W	14000lm	310 x 176 x 120
HBB-HD-C3	150W	21000lm	310 x 267 x 120
HBB-HD-C4	200W	28000lm	310 x 360 x 120
HBB-HD-C6	300W	42000lm	310 x 542 x 120
HBB-HD-C8	400W	56000lm	310 x 726 x 120
HBB-HD-C10	500W	70000lm	310 x 910 x 120
HBB-HD-C12	600W	84000lm	610 x 542 x 120
HBB-HD-C16	800W	112000lm	610 x 726 x 120
HBB-HD-C20	1000W	140000lm	610 x 910 x 120

2-year warranty on all LED products & 1-year warranty on battery-operated products, unless specified. LED warranty void without surge protection. Refer to page 128.

LED FLOODLIGHTS

2 Year Warranty

IDEAL FOR COASTAL REGIONS



LED Graphene Floodlights IP65 - Supply Voltage: 200-265VAC | Colour Temp: 5500K | Material: Body - Graphene, Stirrup Bracket - 316 Stainless Steel, 316 Stainless Steel Screws

Code	Wattage	Lumens	Size (mm)
COS-FL10W-CW	10W	800lm	117 x 92 x 27
COS-FL20W-CW	20W	1600lm	160 x 121 x 30
COS-FL30W-CW	30W	2400lm	202 x 156 x 38
COS-FL50W-CW	50W	4000lm	270 x 210 x 38
COS-FL100W-CW	100W	8000lm	322 x 231 x 38



10W, 30W, 50W

100W

LED Slimline Floodlights - IP65 | Supply Voltage: 85-265VAC | Die-Cast Aluminium | Beam Angle: 110°

Code	Wattage	Lumens	Size (mm)
RW-A010-*	10W	650lm	170 x 200 x 50
RW-A030-*	30W	1950lm	250 x 325 x 80
RW-A050-*	50W	3250lm	320 x 385 x 100
RW-A100-*	100W	6500lm	400 x 480 x 140

*Add Colour to Code: ○ WW (Warm White) 3000K, ○ CW (Cool White) 5500-6000K

Colour Floodlights - Input Voltage: 230VAC | Beam Angle 110° | Ideal for decorative applications



Code	Wattage	Lumens	Size (mm)	Spare Driver
FLC-10W-*	10W	Dependant on colour	115 x 86 x 86	DRV-GY225TG-10W
FLC-20W-*	20W		125 x 120 x 25	DRV-GY225TG-20W
FLC-30W-*	30W		185 x 180 x 25	DRV-GY225TG-30W
FLC-50W-*	50W		225 x 220 x 30	DRV-GY290TG-50W
FLC-100W-*	100W		375 x 290 x 75	DRV-GY470TG-100W
FLC-20W-UV	20W	1600lm	130 x 120 x 40	-

*Add Colour to Code: ● R (Red), ● GN (Green), ● BL (Blue), ● Y (Yellow)

Colour Changing Floodlights - IP65 | Input Voltage: 100-240VAC | Beam Angle 110° | 16 Million Colours + White



Code	Wattage	Lumens	Size (mm)	Spare Driver
FLC-20W-RGBW	20W	Dependant on colour	124 x 100 x 24	DRV-FLC-20W-RGBW
FLC-30W-RGBW	30W		159 x 122 x 26	DRV-FLC-30W-RGBW
FLC-50W-RGBW	50W		205 x 160 x 34	DRV-FLC-50W-RGBW
FLC-100W-RGBW	100W		270 x 210 x 34	DRV-FLC-100W-RGBW

c/w Remote Control to Change Colour RGBW ●●●○

1 Year Warranty



Economy LED Flood Light - Input Voltage: 230VAC | 6500K

Code	Wattage	Lumens	Size (mm)
ECHO-50-CW	50W	2600lm	250 x 130 x 50

LED MOTION SENSOR FLOODLIGHTS

NEW

3CCT ADJUSTABLE
Warm White 3000K
Cool White 4000K
Daylight 5000K



CCT Adjustable PIR Motion Sensor Floodlight IP65 - Input Voltage: 230VAC | CRI 80 | 4kV Surge Protection | Material: Tempered Glass & Die Cast Aluminium | CCT Adjustable 3000-4200-6000K | c/w PIR Motion Sensor

Code	Wattage	Lumens	Size (mm)
PR225TG-30W-CCT	30W	2400lm	150 x 120 x 30
PR225TG-50W-CCT	50W	4000lm	200 x 50 x 30



LED PIR Motion Sensor Floodlight - IP65 | Input Voltage: 230VAC

Code	Wattage	Lumens	Size (mm)
PR225TG-10W-*	10W	800lm	135 x 90 x 25
PR225TG-20W-*	20W	1600lm	175 x 125 x 25
PR225TG-30W-*	30W	2400lm	235 x 185 x 25
PR225TG-50W-*	50W	4000lm	275 x 225 x 30

*Add colour to code: ○ CW (Cool White) 5500-6000K, ○ WW (Warm White) 3000K



LED PIR Motion Sensor Floodlight - IP54 | Input Voltage: 230VAC | Colour Temperature: 6500K | ABS Body | PC Diffuser | PIR Sensor | Adjustable Head

Code	Wattage	Lumens	Size (mm)
WP05-10W-DL	10W	800lm	152 x 140 x 230
WP05-20W-DL	20W	1600lm	134 x 350 x 236

Aluminium Adjustable Spot Head with PIR - IP54 | Input Voltage: 230VAC | Colour Temperature: 6500K | Robust Aluminium Body | Time Adjustable 3s - 7min | Motion Sensor 140° | 20 - 20 000 lux | Max 12m Sensing

Code	Wattage	Lumens	Size (mm)
S1707A-20	20W	1600lm	283 x 189 x 130

NEW



Graphene PIR Motion Sensor Flood IP65 - Input Voltage: 200-265VAC | c/w PIR Motion Sensor | Material: Body Graphene, 316 Stainless Stirrup Bracket and Bolts | Colour Temp. 4200K (Cool White)

Code	Wattage	Lumens	Size (mm)
PIR-N-20W-CW	20W	1600lm	160 x 121 x 30
PIR-N-30W-CW	30W	2400lm	202 x 156 x 30
PIR-N-50W-CW	50W	4000lm	230 x 170 x 30

Industrial

LIGHTING



LED Floodlight Microwave Motion & Day/Night Sensor - IP65 | Input Voltage: 230VAC | Material: Plastic

Code	Wattage	Lumens	Size (mm)
PIR-N-10W-*	10W	800lm	150 x 116 x 36
PIR-N-20W-*	20W	1600lm	150 x 116 x 36
PIR-N-30W-WW	30W	2400lm	170 x 130 x 36
NEW PIR-N-50W-*	50W	4000lm	230 x 170 x 36

*Add colour to code: ○ CW (Cool White) 5500-6000K, ○ WW (Warm White) 3000K



LED Day/Night Sensor Floodlight - IP65 | Input Voltage: 230VAC | Material: Die-Cast Aluminium and Tempered Glass

Code	Wattage	Lumens	Size (mm)
DN-N-10W-*	10W	800lm	92 x 80 x 24
DN-N-20W-*	20W	1600lm	120 x 115 x 24
DN-N-30W-*	30W	2400lm	150 x 120 x 30
DN-N-50W-*	50W	4000lm	200 x 150 x 30
NEW DN-N-100W-*	100W	8000lm	200 x 150 x 30

*Add colour to code: ○ CW (Cool White) 5500-6000K, ○ WW (Warm White) 3000K

NEW

SPECIALISED LED FLOODLIGHTS



WF-FL17-20W-CW/WW

WF-FL17-20W-RGBW



Input Voltage: 230VAC | 110° Beam Angle

Code	Wattage	Lumens	Size (mm)
WF-FL17-20W-CW/WW	20W	2000lm	162 x 36 x 144
WF-FL17-20W-RGBW	20W	2000lm	162 x 36 x 144



NEW



YT-TG-09



YT-TG-BK

Modular

Modular LED Floodlight - IP66 | Input Voltage: 230VAC | Beam Angle 110° | Colour Temp: 6500K | Driver on board | Modular design to allow more fittings to be added horizontally | Optional bracket required when adding fittings.

Code	Wattage	Lumens	Size (mm)
YT-TG-09-DOB	50W	4500lm	240 x 115 x 35

Accessories

Code	Description
YT-TG-BK	Bracket for adding additional fittings (2 Per Pack)

NEW

EMG



LED Floodlights with Emergency Backup Power IP65 - Input Voltage: 230VAC | Beam Angle: 110° | Colour Temp. 6000K | 3 Hour Backup Time | Lithium Ion Battery

Code	Wattage	Emg. Watts	Lumens	Size (mm)
EMG-FL-50W-DL	50W	10W	120lm/W	219 x 188 x 41

NEW

32VAC



LED Boiler Inspection Floodlight IP65 - Input Voltage: 32VAC | Beam Angle: 110° | Floodlight is used for boiler inspection applications

Code	Wattage	Lumens	Size (mm)
FL3-AC-20W-CW 32VAC	20W	1600lm	225 x 185 x 160
FL3-AC-30W-CW 32VAC	30W	2400lm	225 x 185 x 160



FL1



FL3



DC Floodlights - IP65 | Input Voltage: DC | Beam Angle: 110° | Other DC Voltages available on request

Code	Wattage	Lumens	Size (mm)	Spare Driver
FL1-DC-10W-**	10W	800lm	90 x 80 x 24	DRV-FL1-DC-10W-*
FL3-DC-20W-**	20W	1600lm	115 x 110 x 24	DRV-FL3-DC-20W-*
FL3-DC-30W-**	30W	2400lm	150 x 110 x 24	DRV-FL3-DC-30W-*
FL3-DC-50W-**	50W	4000lm	195 x 150 x 30	DRV-FL3-DC-50W-*

*Add Colour to Code: ○ WW (Warm White), ○ CW (Cool White)

*Add Volts to Code: 12VDC, 24VDC, 48VDC

LED FLOODLIGHT ACCESSORIES



Code	Description
GY-SPIKE	Garden spike for ALL LED Floodlights up to 50 Watts

LED WORK LIGHTS IP65



Floor Standing Work Light - Input Voltage: 230VAC | Colour Temp. 6500K
120° Beam Angle

Code	Wattage	Lumens	Size (mm)
NLG08-08C-*	24W	2400lm	410 x 354
WS225TG-20W	20W	2000lm	250 x 190 x 160
WS225TG-30W	30W	3000lm	260 x 220 x 160
NEW WS225TG-50W	50W	5000lm	330 x 270 x 180
WS225TG-100W	100W	8450lm	400 x 350 x 230



Tripod Work Lights - Input Voltage: 230VAC | Colour Temp. 6500K | c/w 2 meter mains cable and plug

Code	Wattage	Lumens	Size (mm)	Spare Stand
NLG08-08B	24W	2400lm	1650 x 295	-
NLG08-08B2	2 x 24W	4800lm	1650 x 600	-
WP225T1-20W-*	20W	2000lm	1650 x 500	WP225T1-STAND
WP225T1-30W-*	30W	3000lm	1650 x 295	WP225T1-STAND
WP225T1-50W-*	50W	5000lm	1650 x 295	WP225T1-STAND
WP225T2-20W-*	2 x 20W	4000lm	1650 x 500	WP225T2-STAND
WP225T2-30W-*	2 x 30W	6000lm	1650 x 600	WP225T2-STAND
WP225T2-50W-*	2 x 50W	10000lm	1650 x 500	WP225T2-STAND

*For Low Voltage add: 12VDC, 24VDC

PORTABLE LIGHTS C/W BATTERY



Rechargeable | c/w charger & car charger | Material: Die-Cast Aluminium | IP65

Code	Wattage	Battery Type	Battery Life	Size	Colour Temp
PFL-5W-*	5W	7.4V, 2200mAh (Li)	3hrs	145 x 166 x 255	DL / RGB
PFL-10W-*	10W	7.4V, 2200mAh (Li)	3hrs	145 x 166 x 255	RGB
PFL-20W-*	20W	14.8V, 4400mAh (Li)	3hrs	215 x 185 x 295	RGB

*Add colour to code: ○ DL (Daylight) 6500K, ● ● ● RGB (Colour Changing)



LED Work Light - Operating Mode: High - Low - SOS - Off | USB Input Charging | USB Output for mobile device charging | Material: Nylon | IP44

Code	Watts	Lumens	Battery Type	Battery Life	Size	Colour Temp
WL03-COB-10W	10W	750lm	7.4V, 2 x 2200mAh (Li)	3hrs High 10hrs Low	173 x 127 x 45	DL (6000K)
WL03-COB-20W	20W	1800lm	11.1V, 3 x 2000mAh (Li)	3hrs High 8hrs Low	173 x 127 x 45	DL (6000K)



DC Work Light IP54 - IK07 | Plastic Body + Steel Tripod | 2m Power Cord | 216pcs SMD LED | 6500K
18.5V 4400mAh | Li-ion Battery | 21V 1A AC230V Charger | 2 Working Modes: 100% - 3100lm @ 2.8hrs, 30% - 1000lm @ 9.2hrs / Ideal for Remote Work Sites

Code	Wattage	Lumens	Battery	Size (mm)	Colour
WL10621-30	30W	105lm/W	18.5V 4400mAh Li-ion	Ø670 x 1126 (open)	6500K

BILLBOARD LIGHT SERIES

Metal Halide
230VAC
Lamp excluded

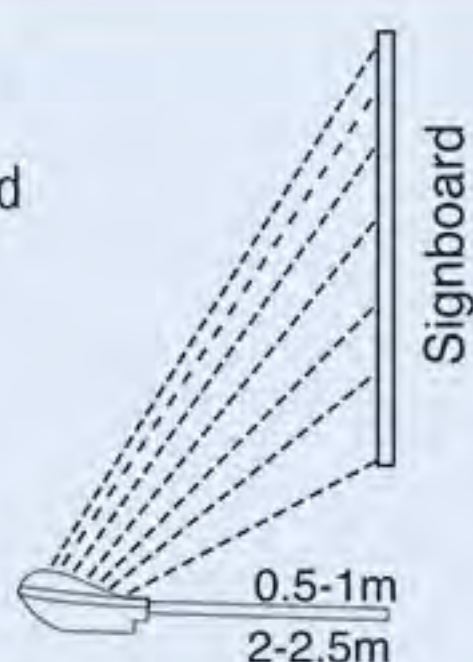

Adjustable Arms for Mounting Floodlights

Powder coated black.
Light fitting excluded.



Joints can rotate
through 270°



Code	GG01	GG012	GG01-EMPTY	Code	JM-ZJ-01	JM-ZJ-02	JM-ZJ-03
Wattage	250W	400W	400W Max	Description	600mm fixed arm	1200mm hinged arm (2 x 600mm)	1800mm hinged arm (3 x 600mm)
Lamp Type	E40/ MTE-250	E40/ MTE-400	CFL/LED	Max Fitting Weight	32kg	14kg	14kg
IP Rating	IP65	IP65	IP65				

LED WALL WASHER FLOODLIGHTS IP65

RGB
16 Million
Static Colour
Shows



RGB
Beam
angle 25°



Single
Colour



Code	LW-AL-300	LW-003-RGB	SL-T204-*
Power	25W/3A	R:12, G:12, B:12 (36 x 1W)	24 x 1W (24W)
Lumen	371lm	371lm	2000-2300lm (White)
Size (mm)	300L x 145W x 225H	343L x 150W x 214H	330L x 160mm
Light Distance	20m	10m	10m
DMX Controller	SRC-174	Independent and DMX512	No DMX
Supply Volts	90-264VAC	100-240VAC	230VAC

*Add colour to code: ● R (Red), ● GN (Green), ● BL (Blue), ● Y (Yellow), ○ PW (Pure White)

RGB LED Wall Washer - 100-256VAC | • Beam Angle 30° | c/w wall brackets



Code	Size (mm)	LED Qty	LED Power	Total Power
LW-020-RGB	500 x 45 x 62	R:4 G:4 B:4	12 x 1W	15W
LW-021-RGB	850 x 45 x 62	R:8 G:8 B:8	24 x 1W	30W
LW-022-RGB	1000 x 45 x 62	R:12 G:12 B:12	36 x 1W	40W
LW-022-RGB-AUTO	1000 x 45 x 62	R:12 G:12 B:12	36 x 1W	40W

LED Wall Washer IP66 - Input Voltage: 240VDC | High Strength Aluminium Housing + Tempered Glass | c/w Mounting Bracket



Code	Wattage	Colour	Beam Angle	Control	Size (mm)
ELI-LW-2626	15W	Cool White (4200K)	120°	Steady	1000 x 26 x 26
ELI-LW-3026	24W	RGB	30°	DMX 512	1000 x 30 x 26
ELI-LW-4226	36W	RGBW	15°	DMX 512	1000 x 30 x 26

Supply Voltage:
230VAC

RGB

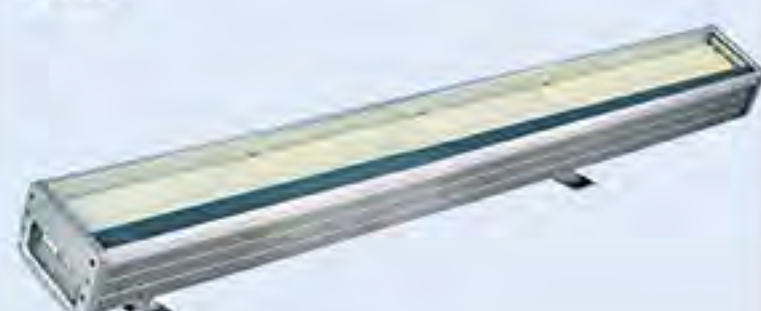

RGB



RGB



Indoor IP20

RGB 110-240VAC
Sound active, auto run mode, colour strobe, dimmer, colour mixing, colour water flow & chasing effects

Code	LW-008	LW-009	LW-024	LW-WF-F10-252
Power/max	1440 x 5mm LEDs (112W max)	144 x 1W (220W max)	36 x 1W (56W max)	252 x 10mm LEDs (50W max)
Lumen	1187lm	1482lm	1112lm	480lm
Size (mm)	1240L x 150W x 172H	1240L x 150W x 172H	1120L x 76W x 163H	1240L x 76W x 163H

Independent and DMX Mode Available beam angle 25°. DMX controller: **DMX-512**

HIGH MAST & STADIUM HID FLOODLIGHTS



Asymmetrical High Performance - IP66 Narrow beam reflector | Sports field lighting | High mast lighting | Security lighting | Area lighting | Airport aprons | Lamps Not Included - See page 22 - 23 for lamps

Code	Lamp Holder	Wattage	Size (mm)
AF-400-*	E40	400W	360 x 450 x 185
AF-600-HPS	E40	600W	360 x 450 x 185

*Add type of switchgear required to code: **MH** (Metal Halide), **HPS** (High Pressure Sodium)



Stadium - IP65 High efficiency light output | Multiple optics - Beam angle adjustable | Perfect solution for stadium lighting designs | Lamps and control gear to be ordered separately

Code Head Piece	Lamp Holder	Wattage	Size (mm)	Lamp Code
YGTH-1000-A1	X528 (Double Ended)	1000	535 x 556 x 242	HQI-TS-1000
YGTH-2000-A1		2000		HQI-TS-2000(Long Arc)

Control Gear IP65 - To be ordered Separately

Code Gearbox	Description	Size (mm)
YGTH-GB-1000	230V, 1000W Gear tray in die-cast aluminium enclosure	295 x 250 x 156
YGTH-GB-2000	400V, 2000W Gear tray in die-cast aluminium enclosure	404 x 268 x 186.5

FLOODLIGHTS - HID

High Pressure Sodium Floodlight **IP55**

Metal Halide Floodlight **IP55**

Mercury Vapour Floodlight **IP55**

Watts	Code Symmetrical	Code Asymmetrical	Lamps	Lamp Holder	Code Symmetrical	Code Asymmetrical	Lamps	Lamp Holder	Code Symmetrical	Code Asymmetrical	Lamps	Lamp Holder
70W	DF-070HPS-S	DF-070HPS-A	ST-70	RX7s	DF-070MH-S	DF-070MH-A	MD-70	Rx7s	-	-	-	-
125W	-	-	-	-	-	-	-	-	-	DF-125MV-A	QE-125	E27
150W	DF-150HPS-S	DF-150HPS-A	ST-150	RX7s	DF-150MH-S	DF-150MH-A	MD-150	Rx7s	-	-	-	-
250W	DF-250HPS-S	DF-250HPS-A	SD-250	E40	DF-250MH-S	DF-250MH-A	MT-250	E40	DF-250MV-S	DF-250MV-A	QE-250	E40
400W	DF-400HPS-S	DF-400HPS-A	SD-400	E40	DF-400MH-S	DF-400MH-A	MT-400	E40	DF-400MV-S	-	QE-400	E40
1000W	DF-1000HPS-S	DF-1000HPS-A	SD-1000	E40	DF-1000MH-S	DF-1000MH-A	MTE-1000	E40	-	-	-	-

For Metal Halide Blue Light 400W use lamp code **JLZ400W-BL** (See page 23)

Order Lamps separately see page 22 - 23



For 70W & 150W
Asymmetrical



For 250W & 400W
Symmetrical



For 250W & 400W
Asymmetrical



For 1000W Asymmetrical
(Supplied with Vossloh-Schwabe ballast)



For 1000W Symmetrical
(Supplied with Vossloh-Schwabe ballast)

FLOODLIGHTS - HID

Metal Halide Plastic Floodlights IP65

Stainless Steel 304 Bracket. C/w control gear. Lamps excluded, see page 22 - 23

Code	Lamp Holder	Watts	Size(mm) H x W x D	Lamp Type
LD3001-70	Rx7s	70W	290 x 240 x 115	MD-70
LD3001-400	E40	450W	400 x 420 x 170	MT-400



LD3001-70



LD3001-400

EMPTY FLOODLIGHTS

Supply Voltage
230VAC
IP55



Code	FL1061-ASY	NB1025 ASY	NB1029-RX7 ASY	F2010 ASY	NB1029-E27 SYM
Type	Asymmetrical	Asymmetrical	Asymmetrical	Asymmetrical	Symmetrical
Lamp Holder	E40	E40	Rx7s/118	E40	E27
Wattage	1000W	400W	70/150W	250/400W	70/150W
Size (mm)	650 x 550 x 205	410 x 420 x 145	230 x 350 x 85	435 x 410 x 158	230 x 350 x 85

Supply Voltage
230VAC
IP55



Code	NB1025 SYM	FL1061-SYM	FL1001	FL1002	FL1003
Type	Symmetrical	Symmetrical	Symmetrical	Symmetrical	Symmetrical
Lamp Holder	E40	E40	E27	E40	E40
Wattage	400W	1000W	70/150W	250/400W	1000W
Size (mm)	410 x 420 x 145	650 x 517 x 227	290 x 225 x 190	415 x 320 x 260	568 x 435 x 420

Supply Voltage
230VAC

IP55



IP65



Plastic

IP65



Plastic

IP54



Code	FL1028	FL1063-E40	FL1063-E27	F2012
Type	Symmetrical	Symmetrical	Symmetrical	Symmetrical
Lamp Holder	E40	E40	2 x E27	E40
Wattage	70/150W	250/400W	70/150W	70/150W
Size (mm)	600 x 480 x 168	390 x 325 x 135	315 x 235 x 125	395 x 224 x 165

PLASTIC ENERGY SAVING FLOODLIGHTS

Supply Voltage
230VAC
Lamps Included
Cool White 4000K



Electronic Ballast



Electronic Ballast



Electronic Ballast

Code (c/w lamp)	FLN001-65	FL1063-18	FL1063-26	FL1063-42
Wattage/Lamp	2 x 65W	2 x 18W	2 x 26W	2 x 42W
Spare Lamp	ESL42-65-E27-D	PLC-18-CW	PLC-26-CW	PLCE-42-CW
IP Rating	IP65	IP65	IP65	IP65
Material	Plastic	Plastic	Plastic	Plastic
Size (mm)	338 x 430 x 118	315 x 235 x 125	315 x 235 x 125	390 x 325 x 135

LED HIGHBAYS

NEW

5 Year Warranty

EMG

160 lm/w



EMG



UFO Power and CCT Adjustable - Supply Voltage: 100 -277VAC | 90° Beam Angle | 0-10V Dimmable | Colour Temp. Selectable 3000K-4000K-5000K | Power Selectable

Code	Wattage	Lumens	Size (mm)
GY160L-60-100W-CCT	60/80/100W	160lm/W	Ø280 x 125
GY160L-120-200W-CCT	120/150/200W	160lm/W	Ø280 x 125

Accessories

Code	Description
GY160L-MMS	Microwave Motion Sensor
GY160L-120L	120 Optic Lens
GY160L-90PCR	90° PC Bowl
GY160L-90ALR	90° Aluminium Bowl
GY160L-MR	Remote Control

Code	Description
HB-EMG-40-90M	Emergency backup power for 0-150W highbay 90min @ 30% Power See page 150 for more info
HB-EMG-60-90M	Emergency backup power for 200W highbay 90min @ 30% Power See page 150 for more info

3 Year Warranty

150 lm/w



UFO Type 120° Beam Angle - Supply Voltage: 100-265VAC | Working Conditions: -40°- 55°C | Working Life: 50 000hrs | CRI > 80 | Power Factor: > 0.95

Code	Wattage	Lumens	Size (mm)
GY630-100-*	100W	15000lm	Ø247 x 90
GY630-150-*	150W	22500lm	Ø256 x 90
GY630-200-*	200W	30000lm	Ø270 x 95

*Add colour to code: ○ CW (Cool White) 4000-4200K or ○ DL (Daylight) 6000K

NEW

5 Year Warranty

EMG

190 lm/w



Selectable Highbay - IP65 Supply Voltage: 100-277VAC | 90° Beam Angle | Colour Temperature: Selectable 3k, 4K, 5K | 0-10V Dimming Plug and Play Modules for added functions.

Code	Wattage	Lumens	Size (mm)
GY200L-60-100W-CCT	60/80/100W	200lm/w	Ø300 x 134
GY200L-100-200W-CCT	100/150/200W	200lm/w	Ø300 x 134

Accessories

Code	Description
GY200L-SEN-PIR	Plug and Play PIR Sensor
GY200L-SEN-REM	Remote control for GY200L
GY200L-ALU-100	Aluminium reflector for GY200L-60-100W-CCT
GY200L-ALU-200	Aluminium reflector for GY200L-100-200W-CCT
GY200L-ALU-PC	PC reflector for GY200L
GY200L-U-BRACKET	U Bracket for GY200L
HB-EMG-60-90M	Emergency backup power for 0-150W highbay 90min @ 30% Power See page 150 for more info
HB-EMG-40-90M	Emergency backup power for 200W highbay 90min @ 30% Power See page 150 for more info

NEW

2 Year Warranty

120 lm/w



DOB LED Highbay - Supply Voltage: 220 -240VAC | Driver on board (DOB) | 120° Beam Angle | CRI 70 | Die-Cast Aluminium with Acrylic lens

Code	Wattage	Lumens	Size (mm)
GY-DOB-100W-*	100W	12000lm	Ø230 x 33
GY-DOB-150W-*	150W	18000lm	Ø290 x 33
GY-DOB-200W-*	200W	24000lm	Ø314 x 33

*Add colour to code: ○ CW (Cool White) 4200K or ○ DL (Daylight) 6000K

LED HIGHBAYS

5 Year Warranty

150 lm/w



EMG



Orion Highbay - Input Voltage: 220-240VAC | 150lm/W | Colour Temperature 5000K | 1 - 10V Dimmable | Supplied with 120° Lens, Interchangeable lenses available
Adaptable Reflectors Available

Code	Wattage	Lumens	Size (mm)
BT-ON100W-UV	100W	15000lm	Ø245 x 184
BT-ON150W-UV	150W	22500lm	Ø280 x 202
BT-ON200W-UV	200W	30000lm	Ø300 x 207

Optional Accessories

Code	Description
BT-ON-LENS-60	60° Fresnel Lens
BT-ON-LENS-90	90° Fresnel Lens
BT-ON-REF-60	60° Aluminium Reflector
BT-ON-REF-90	90° Aluminium Reflector
BT-ON-REF-70	70° Acrylic Reflector
HB-EMG-40-90M	Emergency backup power for 0-150W highbay 90min @ 30% Power See page 150 for more info
HB-EMG-60-90M	Emergency backup power for 200W highbay 90min @ 30% Power See page 150 for more info

5 Year Warranty

130 lm/w



Split Joint Module Highbay - IP65 | Input Voltage: 100 - 265VAC | Honeycomb Shape | 120° Beam Angle | Colour Temperature: 6000K | CRI > 80 | PF > 0.98

Code	Wattage	Lumens	Size (mm)
YT-LED-H27-100	100W	13000lm	Ø200 x 232
YT-LED-H27-200	200W	26000lm	Ø200 x 248
YT-LED-H27-400	2 x 200W (400W)	52000lm	401 x 200 x 248
YT-LED-H27-800	4 x 200W (800W)	104000lm	521 x 521 x 248

Optional Accessories - Reflector

Code	Description
YT-REF-100	Optional 90° Reflector for YT-LED-H27-100
YT-REF-200	Optional 90° Reflector for YT-LED-H27-200

5 Year Warranty

130 lm/w



EMG



Food Processing Applications - IP66 | Input Voltage: 100 - 277VAC | 120° Beam Angle | Colour Temperature 6000K | CRI > 80 | PF > 0.9 | Suitable for cleaning with pressure water jet | Unique design prevents dust & moisture from collecting | Corrosion resistant | No Glass | No Exposed Screws

Code	Wattage	Lumens	Size (mm)
WD10-100W-DL	100W	13000lm	Ø489 x 200
WD15-150W-DL	150W	19500lm	Ø489 x 200
WD20-200W-DL	200W	26000lm	Ø489 x 200

Optional Accessories

Code	Description
HB-EMG-40-90M	Emergency backup power for 0-150W highbay 90min @ 30% Power See page 150 for more info
HB-EMG-60-90M	Emergency backup power for 200W highbay 90min @ 30% Power See page 150 for more info

HIGH BAY WITH CONTROL GEAR

Reflector to be ordered separately

High Pressure Sodium



Metal Halide



Mercury Vapour



Power	HPS Code	Starting Current	Running Current	MH Code	Starting Current	Running Current	MV Code	Starting Current	Running Current
250W	HBB-250HPS	2.10A	1.42A	HBB-250MH	3.00A	1.35A	HBB-250MV	2.60A	1.35A
400W	HBB-400HPS	3.80A	2.20A	HBB-400MH	3.80A	2.20A	HBB-400MV	4.20A	2.10A

Polycarbonate Highbays



Supplied c/w white collar

Control Boxes for Polycarbonate Highbays



Aluminium Highbays



Control Boxes for Aluminium Highbays



Size	Reflector Code	Bowl Cover Code	Code	GB-18	GHK03	GHK05	Size	Reflector Code	Bowl Cover Code	GHK03
410mm	PCR-410	NBC114-2	Size(mm)	240x190x160	260x270x255	225x225x170	410mm	ALR-410	-	260x270x255
485mm	-	-	Material	Sheet Steel	Die-cast Aluminium	Die-cast Aluminium	485mm	-	RW-AL485	Die-cast Aluminium
570mm	PCR-570	NBC114-4	IP-Rating	IP20	IP43	IP20	570mm	ALR-570	RW-AL570	IP43

HIGH BAY WITHOUT CONTROL GEAR

Industrial



Bowl



Code	NB8012	DH-6389	DH-6387
Type	Aluminium	PC	PC
Lampholder	E40	E40	E40
Size	480mm	Ø340 x 330mm	Ø420 x 400mm
Bowl Code	RW-AL480	-	Included
Material of Bowl	Glass	-	-

For lamps see page 22 - 23.
For metal halide ballasts see page 145 - 146.

c/w 1m chain



c/w 1m chain



c/w 1m chain and glass bowl



NB150GB

Code	NB1065-310	NB1065-365	NB1128-310-AL	NB1128-410-AL	NB8016-325	NB8016-430
Type	PC	PC	Aluminium	Aluminium	Aluminium	Aluminium
Lampholder	E27	E27	E27	E27	E27	E40
Size	310Ø x 180mm	365Ø x 240mm	310Ø x 125mm	410Ø x 265mm	325Ø x 375mm	430Ø x 375mm
Code for Bowl	NBC1065	-	NBC1128	NBC1128-410	Included	Included

2-year warranty on all LED products & 1-year warranty on battery-operated products, unless specified.
LED warranty void without surge protection. Refer to page 128.

LED LINEAR HIGHBAYS

**5 Year
Warranty**

**135
lm/w**



BR-HBL-BRKT



BR-HBL-SEN

Industrial Bay - IP65

- Input Voltage: 100-260VAC
- Meanwell Driver | Colour Temp: 5000K
- Phillips SMD LEDs
- 1-10V Dimmable
- Operating Temperature: -20°~ 50°
- Supplied with Suspension Kit

Code	Wattage	Lumens	Beam Angle	Dimensions
LBL-50W-60X100	50W	6750lm	60° x 100°	280 x 137 x 102
LBL-100W-60X100	100W	13500lm	60° x 100°	486 x 137 x 102
LBL-150W-30X70	150W	20250lm	30° x 70°	718 x 137 x 102
LBL-200W-30X70	200W	27000lm	30° x 70°	948 x 137 x 102

Additional Accessories

Code	Description
BR-HBL-SEN	Radar Occupancy Sensor 360°, 15m Max Height
BR-HBL-BRKT	Mounting Bracket for wall or ceiling mounting

LED T-BAY / HIGHBAY

**5 Year
Warranty**



TS-HB-KIT



LED T-Bay / Highbay

- Input Voltage: 120-277VAC
- Colour Temperature 5000K
- 120° Viewing Angle
- c/w Mounting Kit
- 1-10V Dimming
- Applications: Industrial

Code	Wattage	Lumens	Size (mm)
TS-FHB1-110W	110W	14300lm	604 x 244 x 50
TS-FHB2-165W	165W	21450lm	604 x 320 x 50
TS-FHB3-220W	220W	28600lm	604 x 440 x 50
TS-FHB5-220W	220W	28600lm	1168 x 320 x 50
TS-FHB5-300W	300W	39000lm	1168 x 320 x 50

Additional Accessories

Code	Description
TS-HB-KIT	Chain Mounting Kit (Chain Excluded)

LOW BAY FITTING E40 BASE



Low Bay Fitting

Input Voltage: 230VAC | Fitting size: 715 x 320 x 210mm | Lamp not included

Code	Wattage	Lamp Code	Gear
LB-250MH	250W	MT-250-E40	Metal Halide low bay

LED GAS STATION CANOPY LIGHT IP65

5 Year Warranty



CYZ-ECO-100-S - Surface



CYZ-ECO-100-R - Recessed

Standard - Input Voltage: 100-277VAC | Colour Temp. 6000K | Material: Aluminium Alloy | High Quality Chipset for Superior Light Output | Available as Surface or Recess Mount

Code	Wattage	Lumens	Size (mm)	Cut-out Size (mm)
CYZ-100-S	100W	11000lm	420 x 420 x 160	-

Economy - Input Voltage: 100-277VAC | Colour Temp. 6000K | Material: Aluminium Alloy | System designed to be more affordable | Available as Surface or Recess Mount

Code	Wattage	Lumens	Size (mm)	Cut-out Size (mm)
CYZ-ECO-100-R	100W	11000lm	350 x 248 x 115	316 x 200
CYZ-ECO-100-S	100W	11000lm	380 x 380 x 70	-

Power and CCT Adjustable - Input Voltage: 100-277VAC | Surge Protection: 6kV Line to Line, 10kV Line to Earth | Power Adjustable: 120W, 90W, 60W, 36W | Colour Temp. Adjustable: 3000K, 4000K, 5000K | 120° Beam Angle | Die-cast Aluminium and Tempered Glass

Code	Wattage	Lumens	Size (mm)	Cut-out Size (mm)
CP01-120-P-CCT	Max 120W	150lm/W	370 x 369 x 65	-

Accessories

Code	Description
BC-C01-02	Surface Mount Adaptor
BC-C01-01	G314 Conduit Mounting Adaptor

NEW



5 Year Warranty



CP01-120-P-3-T

LED PARKING BAY LIGHT IP65

Industrial

5 Year Warranty



Round Standard - Input Voltage: 230VAC | 160° Beam Angle | Colour Temp. 5000K | CRI > 80 | 1-10V Dimmable

Code	Wattage	Lumens	Size (mm)
BT-ST-60W	60W	8100lm	Ø290 x 114

Round with Built-in Sensor - Input Voltage: 230VAC | 160° Beam Angle | Colour Temp. 5000K | CRI > 80 | 1-10V Dimmable

Code	Wattage	Lumens	Size (mm)
BT-VT-60W	60W	8100lm	Ø290 x 114

Accessories

Code	Description
MC612V-IR	Remote Control to Configure BT-VT-60W

Square Standard - Input Voltage: 100-277VAC | Colour Temp. 6000K | Die-Cast Alu+PC

Code	Wattage	Lumens	Size (mm)
TS-GCP0840	40W	4800lm	255 x 255 x 86
TS-GCP1070	70W	8400lm	255 x 255 x 86

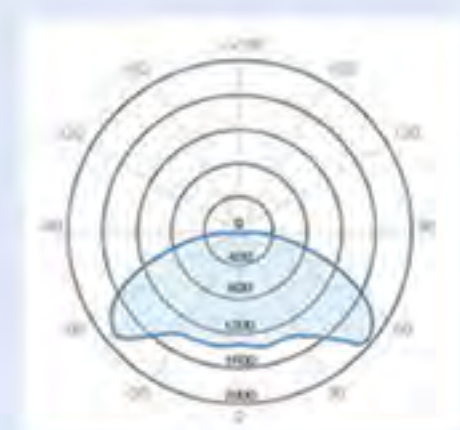

160°



BT-ST-60W / BT-VT-60W



MC612V-IR



TS-GCP0840

LED STREET LAMP - RETROFIT

- WW - 2700K
- CW - 4200K
- DL - 6000K



SP90



TK-VCL

NEW

LED Retrofit Street Lamps

Input Voltage: 230V | Ideal for Retrofit Installations

Code	Wattage	Lumens	Base	Size (mm)	*Colour Temp
SP90-*	28W	2100lm	E40	Ø90 x 275L	WW / DL
TK-VCL-36-*	36W	4680lm	E27	Ø98 x 245	CW / DL

LED STREET LIGHTS

NEW

3 Year Warranty



Adjustable LED Street Lights IP65 - Input Voltage: 230VAC | Beam Angle: 120° | CRI > 80 |

Material: Die Cast Aluminium | Adjustable Tilt

Code	Wattage	Lumens	Size (mm)	Colour Temp
RA-50W-DL	50W	600lm	600 x 75 x 27	DL (6000K)
RA-100W-DL	100W	1200lm	1200 x 75 x 27	DL (6000K)

NEW

3 Year Warranty



Eco 1 LED Street Light IP66 - Input Voltage: 230VAC | Beam Angle: 70° x 140° | CRI > 70 |

Die-Cast Aluminum

Code	Wattage	Lumens	Size (mm)	Colour Temp
RW-ST-FH-50-DL	50W	4500lm	380 x 160 x 70	DL (6000K)
RW-ST-FH-100-DL	100W	9000lm	505 x 205 x 83	DL (6000K)
RW-ST-FH-150-DL	150W	12000lm	600 x 260 x 83	DL (6000K)

NEW

3 Year Warranty



Eco 2 LED Street Light IP66 - Input Voltage: 100-300VAC | Beam Angle: 120° | CRI > 80 |

Die-Cast Aluminum + Tempered Glass

Code	Wattage	Lumens	Size (mm)	Colour Temp
SL-016-20W-DL	20W	2200lm	300 x 110 x 63	DL (6000K)
SL-016-30W-DL	30W	3300lm	300 x 110 x 63	DL (6000K)
SL-016-50W-DL	50W	5500lm	400 x 150 x 78	DL (6000K)
SL-016-100W-DL	100W	11000lm	500 x 180 x 78	DL (6000K)
SL-016-150W-DL	150W	16500lm	500 x 180 x 78	DL (6000K)
SL-016-200W-DL	200W	22000lm	600 x 200 x 83	DL (6000K)

NEW

5 Year Warranty

160 lm/w



Eco 3 LED Street Light IP66 - Input Voltage: 90-305VAC | Beam Angle: 80 x 150° | CRI > 70 |

Aluminium + PC Cover | SPD 10kV/10kA | Pole Entry 40-62mm

Code	Wattage	Lumens	Size (mm)	Colour Temp
SL13-30W-DL	30W	4800lm	408 x 140 x 91	DL (6500K)
SL13-60W-DL	60W	9600lm	646 x 170 x 92	DL (6500K)
SL13-100W-DL	100W	16000lm	475 x 204 x 76	DL (6500K)
SL13-150W-DL	150W	24000lm	572 x 210 x 76	DL (6500K)
SL13-200W-DL	200W	32000lm	673 x 250 x 76	DL (6500K)

2-year warranty on all LED products & 1-year warranty on battery-operated products, unless specified. LED warranty void without surge protection. Refer to page 128.

LED STREET LIGHTS IP65

○ DL - 6000K

5 Year Warranty



Module LED Street Light - Input Voltage: 230VAC | Type III Beam Angle (85 x 135°)

Code	Wattage	Lumens	Size (mm)	Colour Temp
YR-ST-50W	50W	6000lm	373 x 300 x 90	DL
YR-ST-100W	100W	12000lm	473 x 347 x 147	DL
YR-ST-150W	150W	18000lm	529 x 600 x 90	DL
YR-ST-200W	200W	24000lm	607 x 300 x 90	DL
YR-ST-240W	240W	28800lm	685 x 300 x 90	DL
YR-ST-300W	300W	36000lm	763 x 300 x 90	DL

LED STREET LIGHTS IP65

○ DL - 6000K

5 Year Warranty



Knife Switch to cut power when body is opened

Elegant LED Street Light - Input Voltage: 100-265VAC | High Lumen Output > 120lm/W | Installed with Knife Switch to cut power when body is opened | Adjustable Spigot with bottom & side entry adaptor | Die-Cast Aluminium Body

Code	Wattage	Lumens	Size (mm)	Colour Temp
LEDL19-60W	60W	7200lm	640 x 265 x 110	DL
LEDL19-80W	80W	9600lm	640 x 265 x 110	DL
LEDL19-100W	100W	12000lm	700 x 305 x 120	DL
LEDL19-120W	120W	14400lm	700 x 305 x 120	DL

Industrial

CREE

○ DL - 6000K

3 Year Warranty



Flux LED Street Light - Input Voltage: 220-240VAC | Die-Cast Aluminium Body

Code	Wattage	Lumens	Size (mm)	Colour Temp
ZY-6009-LED-40	40W	4000lm	565 x 270 x 145	DL
ZY-6009-LED-60	60W	6000lm	640 x 270 x 160	DL
ZY-6009-LED-80	80W	8000lm	755 x 300 x 215	DL
ZY-6009-LED-120	120W	12000lm	862 x 360 x 231	DL

LIGHTING

HID STREET LIGHTS IP65

Path Finder HID - Input Voltage: 230VAC | SANS 475, SANS 60598-2-3 | UV stabilised polymer body, grey in colour | High impact UV stabilised clear acrylic lens | IP54 Gear compartment, IP65 Lamp compartment | Side Entry



Lamp Excluded-
For Lamps see Page 22 - 23

Code	Wattage	Lamp Type	Igniter	Lamp Holder	Size (mm)
PATH-70-MH	70W	MH & HPS	Yes	E27	591 x 238 x 196
PATH-70-HPS	70W	HPS with Internal Ignitor	No	E27	591 x 238 x 196
PATH-100-MH	100W	MH & HPS	Yes	E27	591 x 238 x 196
PATH-100-HPS	100W	MH & HPS	Yes	E40	591 x 238 x 196
PATH-150-MH	150W	MH & HPS	Yes	E27	591 x 238 x 196
PATH-150-HPS	150W	HPS	Yes	E27	591 x 238 x 196
PATH-EMPTY	EMPTY	-	No	E27	591 x 238 x 196

*Add type of Control Gear required to code: **MH** (Metal Halide), **HPS** (High Pressure Sodium), **EMPTY** (No Control Gear)

Flux HID Street Light Input Voltage: 220-240VAC | Die-Cast Aluminium Body | Tempered Glass Diffuser | Lamps Excluded - For Lamps see page 22 - 23



70W, 150W, 250W



400W

Code	Wattage	Lamp Holder	Pole Entry	Size (mm)
ZY-6009-70-*	70W	E27	Side & Bottom	565 x 220 x 145
ZY-6009-150-*	150W	E27	Side & Bottom	640 x 270 x 160
ZY-6009-250-*	250W	E40	Side & Bottom	755 x 300 x 215
ZY-6009-400-*	400W	E40	Side & Bottom	862 x 358 x 215

*Add type of Control Gear required to code: **MH** (Metal Halide), **HPS** (High Pressure Sodium), **EMPTY** (No Control Gear)

PL STREET LIGHT



Lamp Excluded-
For Lamps see Page 21

Path Finder PL - Input Voltage: 230VAC | SANS 475, SANS 60598-2-3 | UV stabilised polymer body, grey in colour | High impact UV stabilised clear acrylic lens | IP54 Gear compartment, IP65 Lamp compartment

Code	Wattage	Lamp Holder	Pole Entry	Size (mm)
PATH-218	2 x 18W	PLCE	Side	591.5 x 238.8 x 196
PATH-226	2 x 26W	PLCE	Side	591.5 x 238.8 x 196

EMPTY STREET LIGHT FITTING IP65



SFL-1001 & SFL-1001-P



SFL-1002 & SFL-1002-P

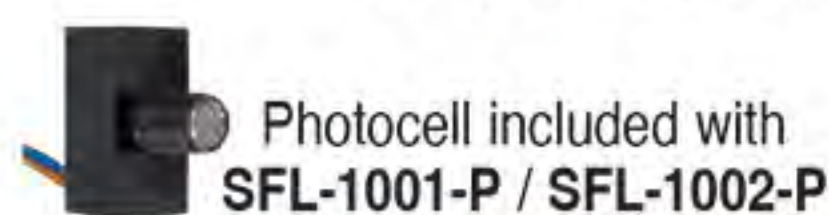

Photocell included with
SFL-1001-P / SFL-1002-P

Input Voltage: 220-240VAC | Complete with 15° Mounting Bracket | E27 Lamp Holder | Polycarb Body | Polycarb Diffuser | Lamps Excluded

Code	Wattage	Pole Entry	Size (mm)
Standard			
SFL-1001	1 x 45W Max	Side	590L x 170W x 150H
SFL-1002	2 x 45W Max	Side	590L x 250W x 170H
Complete with Photocell			
SFL-1001-P	1 x 45W Max	Side	590L x 170W x 150H
SFL-1002-P	2 x 45W Max	Side	590L x 250W x 170H

Input Voltage: 230VAC | Complete with Mounting Arm and Day/Light Switch | E27 Lamp Holder | Die-Cast Aluminium Body | PS Diffuser | Lamps Excluded



Code	Wattage	Pole Entry	Size (mm)
SFL-3001	60W Max	Side	Ø300 x 470H

LED INDUSTRIAL BULKHEADS IP65



Die-cast Aluminium Base | Glass Diffuser with Stainless Steel Clips | CRI > 80 | Colour Temp. 6000K
Emergency version has 1.5hrs Backup at 10W Output

External Driver - 5 Year Warranty

Code	Input Voltage	Wattage	Lumens	Size (mm)
IBG-LED-30W*	85-265V	30W	3000lm	418 x 314 x 203
IBG-LED-60W**	85-265V	60W	6000lm	418 x 314 x 203
IBG-LED-100W**	85-265V	100W	9000lm	418 x 314 x 203
IBG-LED-150W**	85-265V	150W	19500lm	418 x 314 x 203

DOB: Driver on Board - 2 Year Warranty

IBG-LED-30W-DOB*	220-240V	30W	3000lm	418 x 314 x 203
IBG-LED-60W-DOB*	220-240V	60W	6000lm	418 x 314 x 203
IBG-LED-100W-DOB*	220-240V	100W	9000lm	418 x 314 x 203

* For Polycarbonate Lens, add **-PC** to code

* For Emergency, add **-EMG** to code

LED RETROFIT KIT FOR INDUSTRIAL BULKHEADS



IBG & EL-616 Retrofit Kit - CRI>80 | 6000K | Aluminium Tray designed to dissipate heat efficiently

External Driver - 5 Year Warranty

Code	Input Voltage	Wattage	Lumens	Size (mm)
IBG-LEDRRK-30W	85-265V	30W	3000lm	330 x 240
IBG-LEDRRK-60W	85-265V	60W	6000lm	330 x 240
IBG-LEDRRK-100W	85-265V	100W	9000lm	330 x 240

DOB: Driver on Board - 2 Year Warranty

IBG-LEDRRK-30W-DOB	220-240V	30W	3000lm	418 x 314 x 203
IBG-LEDRRK-60W-DOB	220-240V	60W	6000lm	418 x 314 x 203
IBG-LEDRRK-100W-DOB	220-240V	100W	9000lm	418 x 314 x 203



LASCON B40 Retrofit Kit - CRI>80 | 6000K | Aluminium Tray designed to dissipate heat efficiently

DOB: Driver on Board - 2 Year Warranty

B40-LEDRRK-60W-DOB	220-240V	60W	6000lm	290 x 240
B40-LEDRRK-100W-DOB	220-240V	100W	9000lm	290 x 240

LED LOW PROFILE INDUSTRIAL BULKHEADS IP65



Low Profile Die Cast Aluminium Base | Glass Diffuser | Stainless Steel Clips | CI > 80 |
Colour Temp 6000K

External Driver - 5 Year Warranty

Code	Input Voltage	Wattage	Lumens	Size (mm)
IBG-LP-LED-60W*	85-265V	60W	7800lm	414 x 303 x 89
IBG-LP-LED-100W*	85-265V	100W	13000lm	414 x 303 x 89
IBG-LP-LED-150W*	85-265V	150W	19500lm	414 x 303 x 89

DOB: Driver on Board - 2 Year Warranty

IBG-LP-LED-60W-DOB*	220-240V	60W	7800lm	414 x 303 x 89
IBG-LP-LED-100W-DOB*	220-240V	100W	13000lm	414 x 303 x 89
IBG-LP-LED-150W-DOB*	220-240V	150W	19500lm	414 x 303 x 89

* For Polycarbonate Lens, add **-PC** to code

INDUSTRIAL BULKHEADS - HID

Lamp to be ordered separately.

Industrial Bulkheads IP44 - 230VAC, Size: 310 x 258 x 225(D)mm, Polycarbonate Diffuser



IBPC

H.P.S. (High Pressure Sodium)
M.H. (Metal Halide)
M.V. (Mercury Vapour)

Watts	Code						Lamp Holder
	H.P.S.	Lamp	M.H.	Lamp	M.V.	Lamp	
70W	IBPC-70IHPS	SD-70I	IBPC-70MH	MTE-70	-	-	E27
125W	-	-	-	-	IBPC-125MV	QE-125	E27
150W	IBPC-150HPS/MH	SD-150-E27	IBPC-150HPS/MH	MTE-150	-	-	E27

Energy Saving Fittings - Excluding Lamps. Fitted Polycarbon diffuser and die-cast.

2 x 18W	IBPC-218	PLC-18					BCF-G24d2
2 x 26W	IBPC-226	PLC-26					BCF-G24d3
2 x 42	IBPC-242	PLCE-42					BCF-G24q4
	NB1269	-	Empty Body c/w Lampholder				E27

Lamp to be ordered separately.

Industrial Bulkheads IP65 - 230VAC, Size: 418 x 314 x 203(D)mm Glass Diffuser with stainless steel clips.



IBG

Die-cast aluminium base.

H.P.S. (High Pressure Sodium)
M.H. (Metal Halide)
M.V. (Mercury Vapour)

Watts	Code						Lamp Holder
	H.P.S.	Lamp	M.H.	Lamp	M.V.	Lamp	
70W	IBG-70IHPS	SD-70I	-	-	-	-	E27
150W	IBG-150HPS/MH	SD-150	IBG-150HPS/MH	MTE-150	-	-	E27

LED WALL PACK IP65

Supply Voltage: 90-240V | Die-Cast Aluminium | Colour Temp: 6000K



LS-WP



RSWP-*B



RSWP-*C



Code	Wattage	Lumens	Size (mm)
LS-WP30W	30W	2100lm	366 x 185 x 233
LS-WP60W	60W	4200lm	366 x 185 x 233
RSWP-30W-B	30W	2100lm	287 x 272 x 188
RSWP-60W-B	60W	4200lm	287 x 272 x 188
RSWP-30W-C	30W	2100lm	264 x 308 x 182
RSWP-60W-C	60W	4200lm	264 x 308 x 182

INDUSTRIAL BULKHEADS - EMPTY

Industrial Bulkheads - Input Voltage: 230VAC |

E27 Lamp Holder | Lamps Excluded



BK6009



NB1269



EL-616

Code with Lamp Holder	Lens	IP Rating	Size (mm)
BK6009	PC	IP65	260 x 300 x 180
NB1269	PC	IP44	310 x 258 x 255
EL-616	Glass	IP65	418 x 314 x 203

Rectangular Bulkheads - Input Voltage: 230VAC | E27

Lamp Holder | Lamps Excluded | Aluminium Body | Glass Cover



BK6003



FL1057

Code	Lens	IP Rating	Size (mm)
BK6003	PC	IP54	280 x 175 x 133
FL1057	Glass	IP65	330 x 230 x 190

T8 FLUORESCENT WEATHERPROOF LIGHT FITTINGS IP65

ELECTRONIC BALLAST & EMG KIT



YZ Range

3 LAMP



F7 Range

YZ & F7 Range - Material: ABS Base & Clip, Clear Poly-Carbonate diffuser |

Working Temp: **85°C** max | PF >0.97

Lamp Power	Size (mm) L x B x H	Codes			
		Iron Ballast	Electronic Ballast (240V)	Electronic Ballast (110V)	*c/w Emergency Kit
1 x 18W (2FT)	675 x 85 x 90	YZ-8118A	YZ-8118-ELC 240V	-	-
1 x 36W (4FT)	1278 x 85 x 90	YZ-8136A	YZ-8136-ELC 240V	YZ-8136-ELC 110V	YZ-8136-EMG
1 x 58W (5FT)	1578 x 85 x 90	YZ-8158A	YZ-8158-ELC 240V	-	YZ-8158-EMG
2 x 18W (2FT)	675 x 129 x 90	-	YZ-8218-ELC 240V	YZ-8218-ELC 110V	YZ-8218-EMG
2 x 36W (4FT)	1278 x 129 x 90	YZ-8236A	YZ-8236-ELC 240V	YZ-8236-ELC 110V	YZ-8236-EMG
2 x 58W (5FT)	1578 x 129 x 90	-	YZ-8258-ELC 240V	YZ-8258-ELC 110V	-
3 x 18W (2FT)	675 x 220 x 110	F7318	F7318-ELC 240V	-	F7318-EMG
3 x 36W (4FT)	1278 x 220 x 110	F7336	F7336-ELC 240V	-	F7336-EMG

*1 Lamp fitted with emergency kit @ 11% of full power for 1 hour

Accessories For F7 Range

Code	Description
F7-CLIP/P	Plastic holding clips for F7 Diffuser
F7-CLIP/S	S/Steel holding clips for F7 Diffuser

YZ Range - Empty - Material: ABS Base & Clip, Poly-Carbonate diffuser | Working Temp: **85°C** max | Supplied without gear



Opal



Clear

Lamp Power	Size (mm) L x B x H	Codes			
		Body with Clear Diffuser	Spare Clear Diffuser	Body with Opal Diffuser	Spare Opal Diffuser
1 x 18W (2FT)	675 x 85 x 90	YZ-8118-EMPTY	YZ-8118-DIF	-	-
1 x 36W (4FT)	1278 x 85 x 90	YZ-8136-EMPTY	YZ-8136-DIF	-	-
1 x 58W (5FT)	1578 x 85 x 90	YZ-8158-EMPTY	YZ-8158-DIF	-	-
2 x 18W (2FT)	675 x 129 x 90	YZ-8218-EMPTY	YZ-8218-DIF	-	-
2 x 36W (4FT)	1278 x 129 x 90	YZ-8236-EMPTY	YZ-8236-DIF	YZ-8236-OP-EMPTY	YZ-8236-OP-DIF
2 x 58W (5FT)	1578 x 129 x 90	YZ-8258-EMPTY	YZ-8258-DIF	YZ-8258-OP-EMPTY	YZ-8258-OP-DIF

Accessories - For YZ Range

Code	Description	Code	Description
YZ-CLIP/P	Plastic holding clips for YZ Diffuser	YZ-EMG-2X18	2x18W Emergency Ballast c/w Batteries
YZ-CLIP/S	S/Steel holding clips for YZ Diffuser	YZ-EMG-2X36	2x36W Emergency Ballast c/w Batteries
YZ-CLIP/M	S/Steel surface mount clips	YZ-EMG-2X58	2x58W Emergency Ballast c/w Batteries
YZ-CLIP/C	Chassis assembly clips	YZ-BAT	Battery for emergency fitting only
		YZ-EMG	Emergency Ballast

Emergency Accessories - For YZ Fittings



Lockable function

F7D Range - High Temp Rating - Material: Poly-Carbonate Base & Clear Poly-Carbonate diffuser |

Working Temp: **120°C** max | PF >0.97 | Cover & internal plate can be hinged

Lamp Power	Size (mm) L x B x H	Codes			
		Iron Ballast	Electronic Ballast (240V)	*c/w Emergency Kit	Spare Clear Diffuser
2 x 36W (4FT)	1268 x 158 x 101	F-7236D	F-7236D-ELC 240V	F-7236D-ELC 110V	F-7236D-DIF
2 x 58W (5FT)	1568 x 158 x 101	-	F-7258D-ELC 240V	F-7258D-ELC 110V	F-7258D-DIF

Accessories - For F7 & F7-D Range

Code	Description
F7D-CLIP/P	Plastic holding clips for F7-D Diffuser
F7D-CLIP/S	S/Steel holding clips for F7-D Diffuser
F7318-DIF	Spare Diffuser for F7318 Fitting
F7336-DIF	Spare Diffuser for P7336 Fitting



T8 LED WEATHERPROOF LINEAR LIGHTS IP65



LED Tubes to be ordered separately see page 1-3

NEW

Wiring Diagram



LED Standard Weatherproof Linear Light IP65 c/w Fuse Links | Easy Replacement

| Wired for L+N one end, Link Opposite end. LED Tubes Excluded

Clear Diffuser	Opal Diffuser	LED Tube Code	Lamp Power	Size (mm)
Single Tube				
LED-YZ-T8-8W-V2	YZ-8118-OP-EMPTY-V2	LEDT8-A2FR-CW or DL	1x 8W (2FT)	675 x 85 x 90
LED-YZ-T8-18W-V2	YZ-8136-OP-EMPTY-V2	LEDT8-A4FR-CW or DL	1x 18W (4FT)	1278 x 85 x 90
LED-YZ-T8-22W-V2	YZ-8158-OP-EMPTY-V2	LEDT8-A5FR-CW or DL	1x 22W (5FT)	1578 x 85 x 90
Double Tube				
LED-YZ-T8-2X8W-V2	YZ-8218-OP-EMPTY-V2	LEDT8-A2FR-CW or DL	2x 8W (2FT)	675 x 110 x 80
LED-YZ-T8-2X18W-V2	YZ-8236-OP-EMPTY-V2	LEDT8-A4FR-CW or DL	2x 18W (4FT)	1278 x 110 x 80
LED-YZ-T8-2X22W-V2	YZ-8258-OP-EMPTY-V2	LEDT8-A5FR-CW or DL	2x 22W (5FT)	1578 x 110 x 80

For LED tubes see page 1-3 | For Emergency Add Emergency Tube Code on page 3



LED-YZ-CLIP/S-V2

Accessories

Code	Wattage
LED-YZ-CLIP/S-V2	Stainless Steel holding clips for YZ Diffuser



LED Tubes to be ordered separately see page 1-3

Accessories Supplied

LED Economy Weatherproof Linear Light IP65 Material: ABS & Polycarbonate

Diffuser | Supplied without LED Tube

Code	Power	Dimensions
LEDWPT8-109	1 x 9W	650 x 74 x 61mm
LEDWPT8-209	2 x 9W	650 x 110 x 61mm
LEDWPT8-118	1 x 18W	1250 x 74 x 61mm
LEDWPT8-218	2 x 18W	1250 x 110 x 61mm
LEDWPT8-122	1 x 22W	1550 x 74 x 61mm
LEDWPT8-222	2 x 22W	1550 x 110 x 61mm

For LED tubes see page 1-3 | For Emergency Add Emergency Tube Code on page 3



BW-ECO2

LED Weatherproof Linear Light with Motion Sensor IP65 Ideal for parking lots

Input Voltage: 230VAC | ABS + PC | Colour Temperature 6000K | Integrated Microwave Sensor | Time Setting: 10sec to 30min | Light Control: 10-2000 lux | Detection Range: 1-8m (Radius) (Adjustable)

Code	Wattage	Lumen	Size (mm)
BW-ECO2-18	18W	1500lm	568 x 70 x 55
BW-ECO2-36	36W	3000lm	1168 x 70 x 55
BW-ECO2-48	48W	4000lm	1480 x 70 x 55



LG136C-E-S-CW

NEW

Input Voltage: 230VAC | ABS Body + PC Diffuser | Colour Temperature: 4000K | Integrated Microwave Sensor | Time Setting: 5s/90s/5min/15min | Detection Area: 10%-50%-75%-100% | Daylight Threshold: 2lux-10lux-50lux-Disable | Detection Range: Max. Ø14m (Ceiling) and Max. Ø10m (Wall)

Code	Wattage	Lumen	Size (mm)
LG136C-E-S-CW	23W	2300lm	1265 x 89 x 92



LED Integrated Weatherproof Linear Light IP65 - Supply Voltage 230VAC | Colour Temp 6500K (Daylight) | Snap on lens cover (no clips/screws) | Easy connection (no need to open fitting) | PC Base and Lens / Aluminium heat sink

Code	Wattage	Lumen	Max Series Connection	Size (mm)
BW-ECO-18	18W	1500lm	20	590 x 86 x 66
BW-ECO-36	36W	3000lm	10	1180 x 86 x 66
BW-ECO-48	48W	4000lm	8	1480 x 86 x 66

T8 LED WEATHERPROOF LINEAR LIGHTS IP65

LED Mining Weatherproof Linear Light IP65 Input Voltage: 85 - 265VAC | c/w LED Tubes 6000K (Daylight) | c/w 2 x Stainless Steel Clips & 2 x Hooks

Codes c/w LED Tube	Wattage	Supplied with	Size (mm)
MYZ-2X22W	2 x 22W	1.5m Cable & 2P + E 16A Industrial Plug 2 x Daylight LED Tubes	1578 x 129 x 90
MYZ-2X18W-E27	2 x 18W	1.5m Cable & E27 Lamp Holder	1278 x 129 x 90
MYZ-2X22W-E27	2 x 22W	1.5m Cable & E27 Lamp Holder	1578 x 129 x 90

• For LED tubes see page 1-3

• For Emergency Add Emergency Tube Code on page 3



Industrial Plug

MYZ-2X22W



E27 Lamp Holder

MYZ-2X18W-E27
MYZ-2X22W-E27

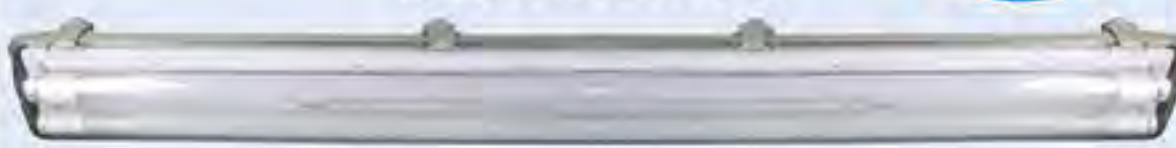

T5 FLUORESCENT WEATHERPROOF FITTINGS IP65

IP65 Weatherproof Light Fitting

Supplied with electronic ballasts

Material: ABS Base & Polycarbonate diffuser

Working Temp: 85°C max



Lamp Power	Single Lamp		Twin Lamp		
	Code	Size L x W x H	Code	c/w Emergency Kit	Size L x W x H
14W(2ft)	YZ-1T514W-ELC 240V	610 x 60 x 74mm	YZ-2T514W-ELC 240V	-	610 x 60 x 74mm
28W(4ft)	YZ-1T528W-ELC 240V	1210 x 60 x 74mm	-	-	1210 x 60 x 74mm
54W(4ft)	YZ-1T554W-ELC 240V	1210 x 60 x 74mm	YZ-2T554W-ELC 240V	-	1210 x 60 x 74mm
35W(5ft)	YZ-1T535W-ELC 240V	1510 x 60 x 74mm	YZ-2T535W-ELC 240V	YZ-2T535W-EMG	1510 x 60 x 74mm
49W(5ft)	YZ-1T549W-ELC 240V	1510 x 60 x 74mm	YZ-2T549W-ELC 240V	-	1510 x 60 x 74mm
80W(5ft)	YZ-1T580W-ELC 240V	1510 x 60 x 74mm	YZ-2T580W-ELC 240V	YZ-2T580W-EMG	1510 x 60 x 74mm

For LED Tubes see page 3

T8 LED STAINLESS STEEL LIGHT FITTINGS IP65

Material: 304 Stainless steel base

& tempered glass diffuser.

Working temperature: 120°C

Application: Chemical factories, etc.



Lamp Power	Size L x W x H	*Wired for LED	Spare Diffuser
1 x 8W (2FT)	710 x 140 x 97mm	LED-SS-8118A	SS-8118-DIF
1 x 18W (4FT)	1310 x 140 x 97mm	LED-SS-8136A	SS-8136-DIF
1 x 22W (5FT)	1610 x 140 x 97mm	LED-SS-8158A	SS-8158-DIF
2 x 8W (2FT)	710 x 210 x 97mm	LED-SS-8218A	SS-8218-DIF
2 x 18W (4FT)	1310 x 210 x 97mm	LED-SS-8236A	SS-8236-DIF
2 x 22W (5FT)	1610 x 210 x 97mm	LED-SS-8258A	SS-8258-DIF

*Note: Lamps Excluded, For LED Tubes see page 1-3 | For Emergency Add Emergency Tube Code on Page 3

Accessories

Code	Description
EL-FL	Fuse Link (To be Ordered Separately for LED Version)

For Polycarbonate diffuser add **-PCDIF** to code. For example: **SS-8258-PCDIF**

T8 FLUORESCENT STAINLESS STEEL LIGHT FITTINGS IP65

Material: 304 Stainless steel base
& tempered glass diffuser.
Working temperature: 120°C
Application: Chemical factories, etc.



Lamp Power	Size L x W x H	Iron Ballast	Electronic Ballast (240V)	Electronic Ballast (110V)	Spare Diffuser
1 x 18W (2FT)	710 x 140 x 97mm	SS-8118A	SS-8118-ELC 240V	SS-8118-ELC 110V	SS-8118-DIF
1 x 36W (4FT)	1310 x 140 x 97mm	SS-8136A	SS-8136-ELC 240V	SS-8136-ELC 110V	SS-8136-DIF
1 x 58W (5FT)	1610 x 140 x 97mm	SS-8158A	SS-8158-ELC 240V	SS-8158-ELC 110V	SS-8158-DIF
2 x 18W (2FT)	710 x 210 x 97mm	SS-8218A	SS-8218-ELC 240V	SS-8218-ELC 110V	SS-8218-DIF
2 x 36W (4FT)	1310 x 210 x 97mm	SS-8236A	SS-8236-ELC 240V	SS-8236-ELC 110V	SS-8236-DIF
2 x 58W (5FT)	1610 x 210 x 97mm	SS-8258A	SS-8258-ELC 240V	SS-8258-ELC 110V	SS-8258-DIF

For Polycarbonate Diffuser add **-PCDIF** to code. For example: **SS-8258-PCDIF**

T8 LED ALUMINIUM FITTINGS IP65



LED-F7118F

Wired for LED	Lamp Power	Size L x W x H
LED-F7118F	1 x 8W (2FT)	675 x 120 x 95mm
LED-F7218F	2 x 8W (2FT)	675 x 150 x 95mm
LED-F7136F	1 x 18W (4FT)	1285 x 120 x 95mm
LED-F7158F	1 x 22W (5FT)	1585 x 120 x 95mm

For Lamps see page 1-3 | For Emergency Add Emergency Tube Code on Page 3

Accessories

Code	Description
NF7-CLIP/S	Spare Stainless Steel Clips
EL-FL	Fuse Link (To be Ordered Separately for LED Version)

Material: Aluminium base and tempered glass cover. Stainless Steel Clips

For Spare Glass add **-DIF** to Code. For example: **F7258F-DIF**

LED WEATHERPROOF LINEAR LIGHTING IP65

LED Tri-Proof Fitting - Input Voltage: 230VAC | 130lm/W | Colour Temperature: 6000K | Seamless Connection | c/w Surface Mounting Kit | c/w Waterproof End Cap | Suspension Kit Optional | Power-Connector not included

Code Standard - 2 Wire	Code Dimmable	Wattage	Lumen	Size (mm)
01TP-C2F-15	01TP-C2F-D-15	15W	1950lm	600 x 67 x 67
01TP-C4F-33	01TP-C4F-D-33	33W	4290lm	1200 x 67 x 67
01TP-C5F-45	01TP-C5F-D-45	45W	5850lm	1500 x 67 x 67

Emergency - Lithium Ion | With Test Button | 4 Wire

Code	Wattage	Lumen	Size (mm)
01TP-C2F-E-15	15W	1950lm (E-280lm)	600 x 67 x 67
01TP-C4F-E-33	33W	4290lm (E-460lm)	1200 x 67 x 67
01TP-C5F-E-45	45W	5850lm (E-560lm)	1500 x 67 x 67

Accessories - 2 Wire & 4 Wire

2 Wire Codes	Description	4 Wire Codes	Description
01TP-2W-PC	1m Power Connector	01TP-4W-PC	1m Power Connector
01TP-2W-JB	Seamless Joining Bracket	01TP-4W-JB	Seamless Joining Bracket
01TP-2W-JL	1m Jumper Lead	01TP-4W-JL	1m Jumper Lead
01TP-2W-MS	Microwave sensor	01TP-4W-MS	Microwave sensor



5 Year Warranty

Standard 2 Wire

Dimmable

O1TP Suspension Kit

Emergency



1m Jumper Lead

1m Power Connector

Seamless Joining Bracket

Microwave Sensor

2-year warranty on all LED products & 1-year warranty on battery-operated products, unless specified. LED warranty void without surge protection. Refer to page 128.

LED WEATHERPROOF LINEAR LIGHTING IP65

LED Weatherproof Linear Light - Input voltage: 230VAC | Extruded body | IK08 | RA > 80 | Mounting Kit Included | 400W max in series



Code	Wattage	Lumen	Size (mm)
Ultra Slim - Linkable / PC Diffuser			
OBH-S-18W-*	18W	1440lm	600 x 43 x 38
OBH-S-36W-*	36W	2880lm	1200 x 43 x 38
OBH-S-45W-*	45W	3840lm	1500 x 43 x 38

Accessories

Code	Description
OBH-MC	1m Middle Connector
OBH-PC	500mm Power Connector

Code	Wattage	Lumen	Size (mm)
Standard Slimline - Quick Connect Power Adaptor			
LG08C-06-18W-*	18W	1650lm	650 x 72 x 42
LG08C-12-36W-*	36W	3300lm	1250 x 72 x 42
LG08C-15-45W-*	45W	4000lm	1560 x 72 x 42

High Power Slimline - With 230mm Fly Lead

Code	Wattage	Lumen	Size (mm)
MDT-1701-SMD30-*	30W	2700lm	662 x 78 x 38
MDT-1702-SMD60-*	60W	5400lm	1232 x 78 x 38
MDT-1703-SMD70-*	70W	6300lm	1532 x 78 x 38

*Add colour to code: ○ CW (Cool White) 4200K, ○ DL (Daylight) 6000K

LED Weatherproof Linear Light - Supply Voltage 100 - 240VAC | 2 x LED chip boards to ensure even lighting | Colour temp 6500K (Daylight) | PC Base and Lens | Aluminium heat sink | Series connection possible | Easy connection | Mounting Kit Included

Code	Wattage	Lumen	Size (mm)
RW-PK-WP60-1	9W	800lm	610 x 50 x 49
RW-PK-WP120-1	18W	1600lm	1210 x 50 x 49
RW-PK-WP150-1	22W	1900lm	1510 x 50 x 49



LED WEATHERPROOF LINEAR LIGHTING IP65

LED Linear Light - Input Voltage: 110-240VAC | Linkable | Easy Installation | c/w Mounting Clips, End Caps and 300mm Power Connector

Codes	Wattage	Lumen	Size (mm)
YB-SFD01-18W-*	18W	1500lm	600 x 60 x 29
YB-SFD01-36W-*	36W	3200lm	1200 x 60 x 29

*Add Colour to Code: ○ CW (Cool White - 4200K), ○ DL (Daylight - 6000K)

Code (Accessories)	Description
YB-SFD-PC	300mm Power Connector
YB-SFD-MC	Middle Connector for Linking



LED WEATHERPROOF LINEAR LIGHTING IP66

Narrow Body - Input Voltage: 230VAC | Integrated LED | CRI ≥80 | Material: PC | Mounting Clips Included | Supplied with 230mm Fly Lead

Code	Power	Lumens	Size (mm)
ZJT-0760-15W-*	15W	1425lm	600 x 70 x 65
ZJT-0790-20W-*	20W	1900lm	900 x 70 x 65
ZJT-07120-36W-*	36W	3600lm	1200 x 70 x 65
ZJT-07150-42W-*	42W	4200lm	1500 x 70 x 65

Wide Body - Input Voltage: 230VAC | Integrated LED | CRI ≥80

Code	Power	Lumens	Size (mm)
ZJT-1360-20W-*	20W	1900lm	600 x 134 x 61
ZJT-1390-30W-*	30W	2850lm	900 x 134 x 61
ZJT-13120-42W-*	42W	4200lm	1200 x 134 x 61

*Add colour to code: ○ CW (Cool White) 4200K, ○ DL (Daylight) 6000K



Commercial

LIGHTING

LED RECESSED PANELS IP40

NEW 5 Year Warranty



P0606



Backlit Panel - Input Voltage: 100-240VAC | High Quality | Ultra Efficient | 110lm | Low Glare | PMMA Diffuser | Suspension Kit available under Accessories

Code	Wattage	Lumen	Size (mm)	Spare Driver
DFL-P0606-40W-CCT	40W	4400lm	595 x 595 x 30	DRV-DFL-40W
DFL-P0606-64W-CCT	64W	7040lm	595 x 595 x 30	DRV-DFL-64W
DFL-P1203-40W-CCT	40W	4040lm	1195 x 300 x 30	DRV-DFL-40W
DFL-P1206-64W-CCT	64W	7040lm	1195 x 595 x 30	DRV-DFL-64W

3 Year Warranty



DFL



DIM-DFL

Sidelit Panel - 3 Year Warranty panels are designed for normal operating conditions at 8hrs a day. It is recommended to use the 5 Year Warranty panels for operating hours above 8hrs. Warranty void if panels are incorrectly specified for the application.

Code	Wattage	Lumen	Size (mm)	Spare Driver
Standard - Supply Voltage: 100-240VAC CRI > 80 Lumen Output 100lm/W				
DFL-P0303-*	21W	2100lm	300 x 300 x 12	DRV-DFL-21W
DFL-P0606-72W-CW	72W	7200lm	595 x 595 x 12	DRV-DFL-72W
DFL-P1203-CW	52W	5200lm	1195 x 300 x 12	DRV-DFL-52W

Dimmable - Supply Voltage: 100-240VAC | Panels have a 1-10V input on driver (use **GL-CA-1** Dimmer)

DIM-DFL-P0303-*	21W	2100lm	300 x 300 x 12	DIM-DRV-DFL-21W
DIM-DFL-P0606-40W-*	52W	5200lm	1195 x 300 x 12	DIM-DRV-DFL-52W
DIM-DFL-P1203-*	72W	7200lm	1195 x 595 x 12	DIM-DRV-DFL-72W
DIM-DFL-P1206-72W-*	40W	4000lm	595 x 595 x 12	DIM-DRV-DFL-40W

* Add colour to code: ○ **CW** (Cool White) 4200K, ○ **DL** (Daylight) 6000K

NEW

5 Year Warranty

120 lm/w



High Performance Backlit Panel - Input Voltage: 220-240VAC | CRI > 80 | 120lm/W | Flicker Free | High Quality | Ultra Efficient | Low Glare | PMMA Diffuser | Suspension Kit available under accessories

Codes	Wattage	Lumen	Size (mm)	Spare Driver
HP-0606-40W-*	40W	4800lm	595 x 595 x 30	HP-DRV-40W
HP-60120-60W-*	60W	7200lm	595 x 1195 x 30	HP-DRV-60W

* Add colour to code: ○ **CW** (Cool White) 4200K, ○ **DL** (Daylight) 6500K

NEW



Splicing Frame Panel Light - Input Voltage: 220-240VDC | CRI>80 | Material: PC | High Light Output | Surface or Recess Mount | Elegant Design

Code	Wattage	Lumen	Size (mm)
SEC-L-PL225-36W-*	36W	2600lm	595 x 595 x 20
SEC-L-PL225-40W-*	40W	4000lm	595 x 595 x 20
SEC-L-PL225-48W-*	48W	4800lm	595 x 595 x 20

* Add colour to code: ○ **CW** (Cool White) 4200K, ○ **DL** (Daylight) 6000K

Dali Dimmable LED Panel - Input Voltage: 180-265VAC | CRI >80 | Beam

Angle 120° | Meanwell Dali Dimmable Driver

Codes	Wattage	Lumen	Size (mm)	Spare Driver
DALI-DFL-P0606-*	40W	4000lm	595 x 595	DRV-DFL-40W
DALI-DFL-P1206-*	60W	6000lm	1195 x 595	DRV-DFL-60W

* Add colour to code: ○ **CW** (Cool White) 4200K, ○ **DL** (Daylight) 6500K

3 Year Warranty



LED RECESSED PANELS

2 Year Warranty



Daylight Harvesting - Input Voltage: 100-277VAC | Beam Angle 80° | UGR 19 | CRI > 80 | Built in daylight sensor to sense movement & calculate ambient light to automatically adjust light output to set parameters

Code	Wattage	Lumens	Size (mm)
PL-0606-*	40W	3790lm	595 x 595 x 44

* Add colour to code: ○ CW (Cool White) 4200K, ○ DL (Daylight) 6000K

Accessories

Code	Description
PL-RMC	Remote Control for setting Parameters



RGB - Supply Voltage: 100-240VAC | ●●● RGB | c/w Remote

Codes	Wattage	Lumen	Size (mm)	Spare Driver
DFL-P0606-46W-RGB	46W	3220lm	595 x 595 x 50	DRV-DFL-46W-RGB

2 Year Warranty



LED Emergency Panel IP40 - Input Voltage: 230VAC | 1hr Backup time - Half power during backup | Green light - Main line, Red light - Charging, Yellow light - Error | Ni-MH Rechargeable battery

Codes	Wattage	Lumen	Size (mm)
EMG-DFL-P0606-40W-*	40W	4000lm	595 x 595
EMG-DFL-P1206-60W-*	50W	5000lm	1195 x 595

* Add colour to code: ○ CW (Cool White) 4200K, ○ DL (Daylight) 6500K

Accessories

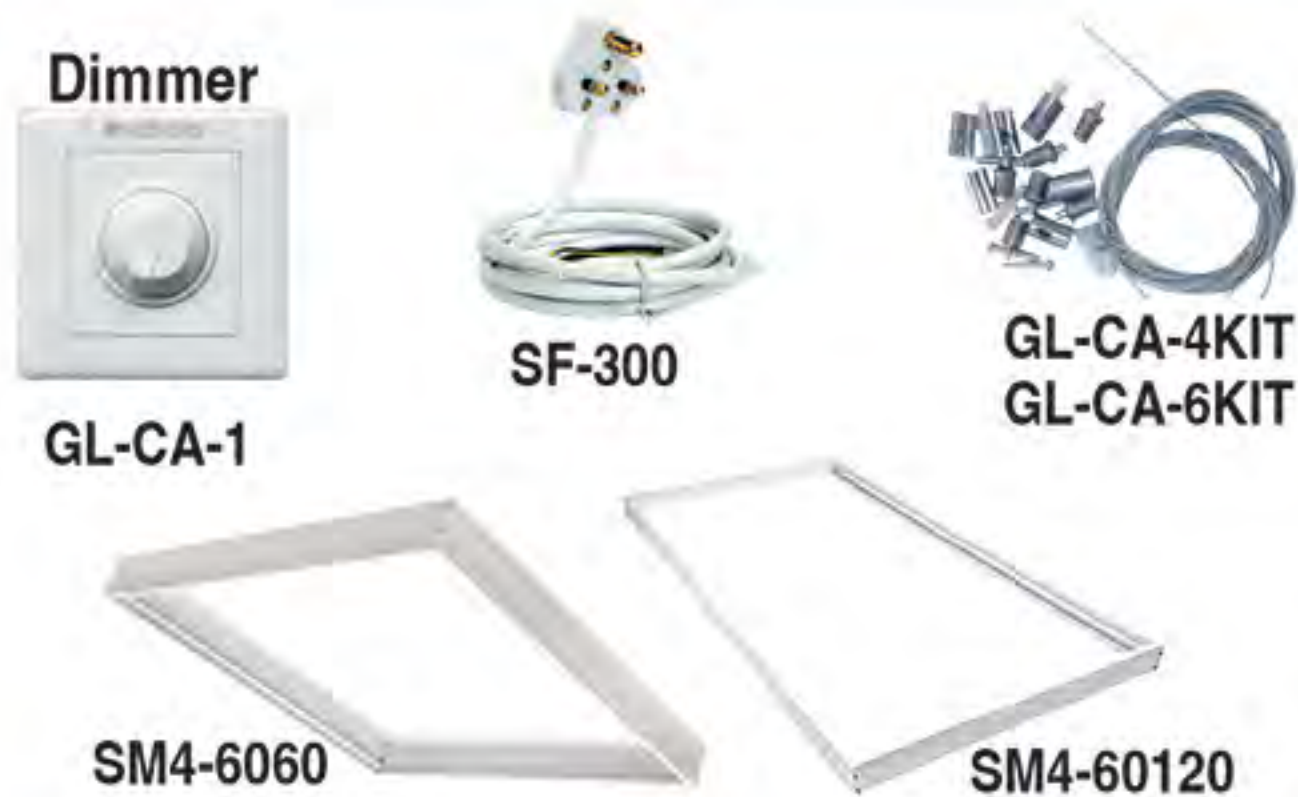

Code	Description
SF-300	2m 0.75 x 3 Core Cable with 5Amp Plug
GL-CA-4KIT	4 Pcs of wire for 300x300 or 600x600 panels
GL-CA-6KIT	6 Pcs of wire for 1200x300 or 1200x600 panels
GL-CA-1	Up to 144W (230VAC) 1-10V Output (No Max Load)
SM4-6060	595 x 595 x 10mm Surface Mount Bracket for LED Panel
SM4-60120	595 x 1195 x 10mm Surface Mount Bracket for LED Panel
DFL-4H	Suspension bracket for 600x600 backlit panel
DFL-6H	Suspension bracket for 1200x600 backlit panel

Commercial

LED RECESSED FITTINGS

5 Year Warranty

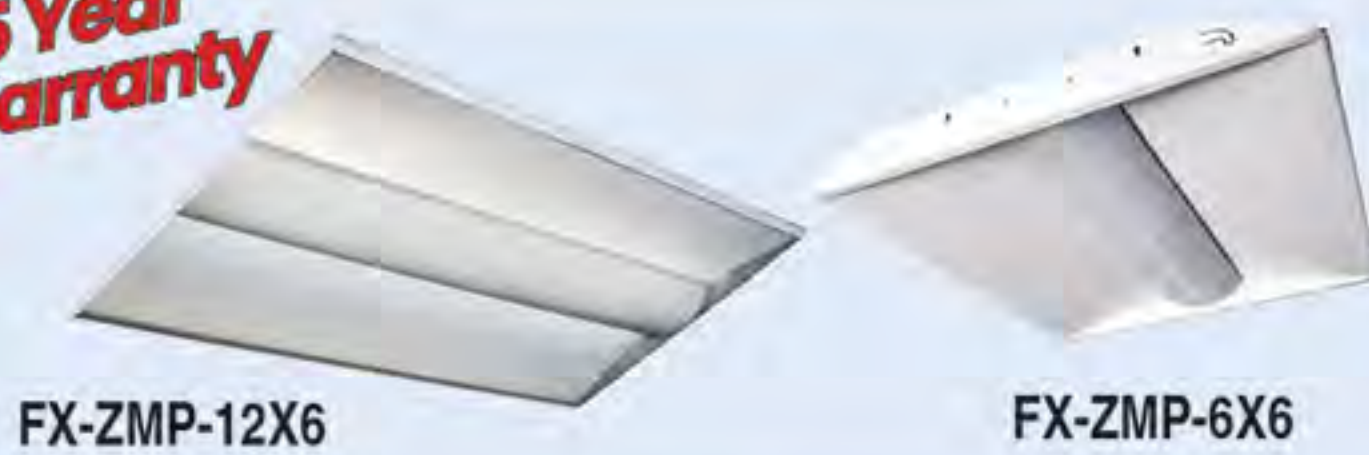

Recessed Indirect Fitting - Input Voltage: 85-265VAC | Integrated LEDs

Codes	Wattage	Lumen	Size (mm)
FX-ZMP-6X6-*	46W	4600lm	595 x 595 x 95
FX-ZMP-12X3-*	53W	5300lm	1195 x 295 x 95
FX-ZMP-12X6-*	53W	5300lm	1195 x 595 x 95

* Add colour to code: ○ CW (Cool White) 4200K, ○ DL (Daylight) 6500K

LED Tubes & Fuse Links Excluded



Recessed Fitting with Prismatic Diffuser - Wired for T8 LED tubes

Code	No. of Lamps/ Power	Size (mm) L x W x H
LED-66123	3 x 2FT	595 x 595 x 90
LED-66123P4	4 x 2FT	595 x 595 x 90
LED-66143	3 x 4FT	595 x 1195 x 90
LED-66143P4	4 x 4FT	595 x 1195 x 90

For LED tubes see page 1-3 | For Emergency Add Emergency Tube Code on page 3

LED Tubes & Fuse Links Excluded



Recessed Fitting Aluminium Parabolic Louvre - Wired for T8 LED tubes

Code	No. of Lamps/ Power	Size (mm) L x W x H
LED-8123P3	3 x 2FT	595 x 595 x 90
LED-8123P4	4 x 2FT	595 x 595 x 90
LED-8143P3	3 x 4FT	595 x 1195 x 90
LED-8143P4	4 x 4FT	595 x 1195 x 90

LED SURFACE OFFICE FIXTURES

LED



LED Fitting with Curved Opal Diffuser - Integrated LED

Code	Wattage	Lumens	Size (mm)
DW-LED-MX-18-*	2 x 9W	1440lm	600 x 155 x 65
DW-LED-MX-36-*	2 x 18W	2880lm	1200 x 155 x 65

*Add Colour to Code: ○ CW (Cool White - 4200K), ○ DL (Daylight - 6000K)

LED



LED Light with Prismatic Diffuser - Input Voltage: 100-240VAC | Colour Temp.: 6000K (Daylight) | LED tubes Included

Code	Wattage	Lumen	Size (mm)
LU-508-8W	8W	800lm	628 x 100 x 60
LU-508-18W	18W	1600lm	1238 x 100 x 60
LU-509-2X8W	2 x 8W	1600lm	628 x 164 x 60
LU-509-2X18W	2 x 18W	3400lm	1238 x 164 x 60
LU-509-2X22W	2 x 22W	3800lm	1538 x 164 x 60

LED T8 SURFACE FITTINGS



LED T8 Steel Surface Mount IP20 - V-Shaped Louvre Grill | c/w Fuse Links | Pre-wired for LED Tube

Code	T8 Lamp	Size (mm)
LED-ETL240VG	2 x 18W	1250 x 303 x 68

T8 RECESSED OFFICE FLUORESCENT FITTINGS



Recessed Fittings Aluminium Parabolic Louvre c/w P.F. Capacitor - Emergency Kit fitted @ 12% of full power for 3 hours @ 36W | Lamps excluded | Hinged Reflector for easy maintenance

Code	No. of Lamps/ Power	Size (mm) L x W x H	1 Lamp fitted with EMG kit
SF-8123P3* *	3 x 18W (2FT)	595 x 595 x 90	SF-8123P3-EMG
SF-8123P4*	4 x 18W (2FT)	595 x 595 x 90	SF-8123P4-EMG
SF-8143P3* *	3 x 36W (4FT)	595 x 1195 x 90	SF-8143P3-EMG
SF-8143P4*	4 x 36W (4FT)	595 x 1195 x 90	SF-8143P4-EMG

*For electronic ballast add -ELC. * For 2m cord set add SF to code

Accessories

Code	Description
SF-300	2 meter 0.75 x 3 core cable with 5 Amp Plug
SF-305	3 meter 0.75 x 3 core cable with 5 Amp Plug
SF-304	Assembly of 2 meter cable to light fitting
SF-8143P3-DIF	Spare 1200 x 600 Aluminium Parabolic Reflector
SF-8143P4-DIF	Spare 1200 x 600 Aluminium Parabolic Reflector
PT-C08	Lamp holder



Spare Reflector

SF-300

PT-C08

Recessed Fittings Prismatic Diffuser c/w P.F. Capacitor - Emergency Kit fitted @ 12% of full power for 3 hours @ 36W | Lamps excluded.

Code	No. of Lamps/ Power	Size (mm) L x W x H	1 Lamp fitted with EMG kit
SF-66123*	3 x 18W (2FT)	595 x 595 x 90	SF-66123-EMG
SF-66123P4*	4 x 18W (2FT)	595 x 595 x 90	SF-66123P4-EMG
SF-66143*	3 x 36W (4FT)	595 x 1195 x 90	SF-66143-EMG
SF-66143P4*	4 x 36W (4FT)	595 x 1195 x 90	SF-66143P4-EMG

*For electronic ballast add -ELC

Accessories

Code	Description
SF-300	2 meter 0.75 x 3 core cable with 5 Amp Plug
SF-304	Assembly of 2 meter cable to light fitting
SF-8123-DIF	Spare 600 x 600 Aluminium Parabolic Reflector
SF-66123-DIF	Spare 600 x 600 Prismatic Diffuser
SF-66143-DIF	Spare 1200 x 600 Prismatic Diffuser
PT-C08	Lamp Holder



Spare Diffuser

SF-300

PT-C08

LED LINEAR LIGHTING IP20



LED Single Round Shape Pendant

- Supply voltage: AC 190-240V
- Material: Aluminium
- Power factor: PF > 0.9
- Beam angle: 145°
- Mounting Kit: Included

Code	LD-PD-SR-18W
Wattage	18W
Luminous Flux	1260lm
Colour Temperature	6000K (Pure White)

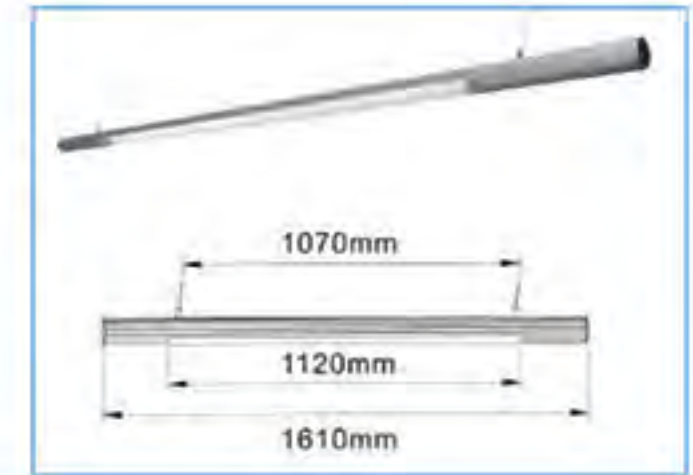

LED Double Round Shape Pendant

- Supply voltage: AC 190-240V
- Material: Aluminium
- Power factor: PF > 0.9
- Beam angle: 145°
- Mounting Kit: Included

Code	LD-PD-DR-36W
Wattage	36W
Luminous Flux	2520lm
Colour Temperature	6000K (Pure White)

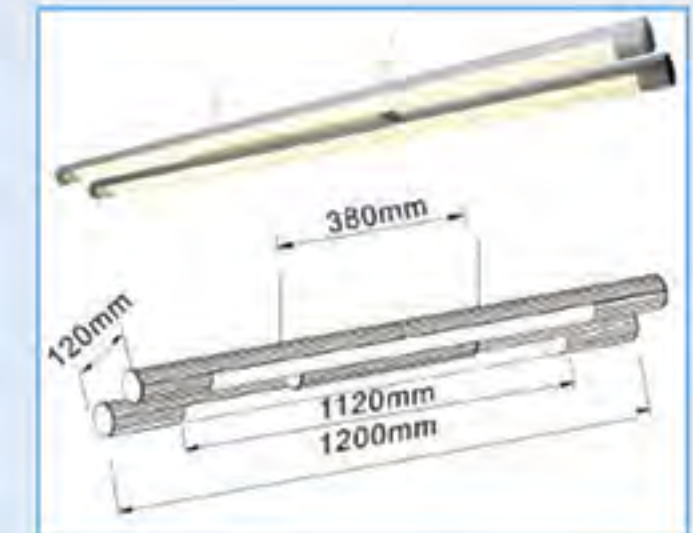

LED CONNECTABLE LINEAR LIGHTING IP20



LED Two-In-One Pendant Lighting -

Can be used as either an individual fitting or can be connected using the accessories below.

- Supply voltage: AC 190-240V
- Material: Aluminium
- Power factor: PF > 0.9
- Beam angle: 145°
- Mounting Kit: Included

Code	LD-PD-EL-36W
Wattage	36W
Luminous Flux	90lm/W
Colour Temperature	6000K (Pure White)

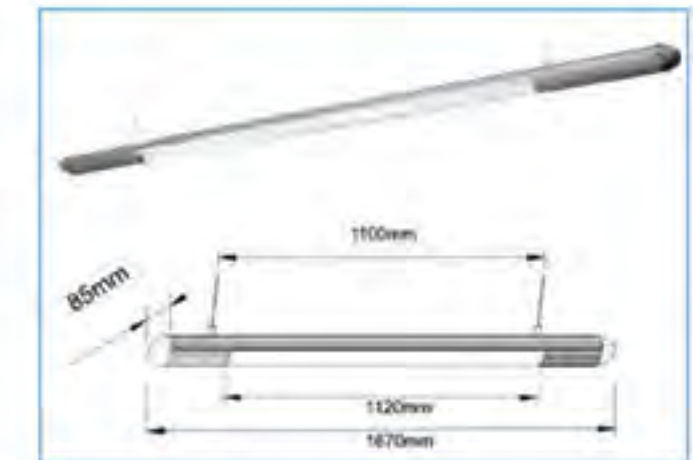

Connectable Accessories



Code	LD-SC	LD-LC	LD-TC	LD-XC	LD-CB
Description	Straight connector 100 x 80 x 51mm	Left or Right bend 80 x 80 x 51mm	"T" Type connector 100 x 90 x 51mm	"+" Type connector 100 x 100 x 51mm	Spare connector block

NEW

3 Year Warranty



FD-LL



Adjustable Linkable Linear Light IP20 - Input Voltage: 230VAC | CRI>80 | 120 Beam Angle | Aluminium Body & PC Diffuser | Max Connection wattage in series 1000W | Ends have rotatable connectors to create T, L & X Connection

Code	Wattage	Lumens	Size (mm)
FD-LL-12W-CCT	12W	960lm	300 x 55 x 55
FD-LL-24W-CCT	24W	1920lm	600 x 55 x 55
FD-LL-36W-CCT	36W	2880lm	900 x 55 x 55
FD-LL-50W-CCT	50W	4000lm	1200 x 55 x 55
FD-LL-60W-CCT	60W	4800lm	1500 x 55 x 55
FD-LL-80W-CCT	80W	6400lm	2000 x 55 x 55

Accessories

Code	Description
FD-LL-SK	1.5m Suspended Mounting Kit
FD-LL-RK	Linear Recessed Mounting Kit
FD-LL-SMK	Linear Surface Mounting Kit
FD-LL-PC	1.5m Power Cable
FD-LL-MPC	2m Middle Power Connector



FD-LL-RK



FD-LL-SMK



FD-LL-PC

LED LINEAR LIGHTING IP20

5 Year Warranty

140 lm/w



Aluminium Linkable without Parabolic Reflector - Input Voltage: 180 - 240VAC | 2 Part Design | Single or Interlink | Seamless Design | 120° Beam Angle | Frosted Diffuser

Code	Wattage	Lumens	Size (mm)
LINA-120-40-*	40W	5600lm	1190 x 57 x 67
LINA-150-60-*	60W	8400lm	1490 x 57 x 67

*Add colour temp to code: ○ **CW** (Cool White - 4000K), ○ **DL** (Daylight - 6000K)

Accessories

Code	Description
LIN1A-A	Middle Connector
LIN01-B	Suspension Kit, 2Pcs, 1 Meter Length
LINA-R-12	1200mm Parabolic Reflector
LINA-R-15	1500mm Parabolic Reflector

ALUMINIUM LED LINEAR LIGHTS IP40

LED Linear Light - c/w 1m Suspension Kit and Linking Connector | Linkable

Code	XLN-1200-40W-*	XLN-1500-50W-*
Voltage	230VAC	230VAC
Power	36W	48W
Size (mm)	1200 x 54 x 85	1500 x 54 x 85
Lumen	3060	4080
CRI	80	80

*Add colour to code: ○ **CW** (Cool White), ○ **WW** (Warm White)

Aluminium Profile - Empty | Ready to fit Strip Light

Code	Description	Code	Description
ALP052/2M	2m Aluminium Profile	ALP052-EC	End Cap with Hole
ALP052-FD	PC Diffuser Cover (Frosted)	ALP052-SW	2m Suspension Wire
ALP-LINK	Middle Connector to join two profiles		

(To make up complete set, order profile, diffuser, end cap & suspension wire)

LED Linear Light - 230VAC | c/w 1m Suspension Kit

Code	GL-LS3050-1200-*	GL-LS3050-1500-*	GL-LS3050-2400-*
Power	23W	28W	36W
Size (mm)	1200 x 38 x 60	1500 x 38 x 60	2400 x 38 x 60
Lumen	1800lm	2300lm	3600lm

*Add colour to code: ○ **WW** (Warm White), ○ **CW** (Cool White)

Code (Accessories)	Description
GL-LS3050-WIRE	1m Suspension Kit
GL-LS3050-FLUSH	Surface Mount Bracket
GL-LS3050-LINK	Middle Connector to join two profiles



NEW

3 CCT ADJUSTABLE LINEAR LIGHTS

3CCT Adjustable Linear Light - High quality LED linear light for office, architectural, school, display centres, shops and stores | Colour Temperature Adjustable by Switch | Suspended or Surface Mount | c/w Suspension Kit and Linkable Link | Aluminium Body & PC Diffuser

Code	HZ-L600-20W-*	HZ-L1200-40W-*
Voltage	100-270VAC	100-270VAC
Wattage	20W	40W
Size (mm)	600 x 55 x 70	1200 x 55 x 70
Lumens	2000lm	4000lm
Selectable Colour Temp.	2700K-4100K-5500K	2700K-4100K-5500K

* Add Finish Colour to Code: **S** (Silver), **BLK** (Black)



LED LINEAR LIGHTING IP20

LED T8 Battens - Input Voltage: 220 - 240VAC | No Light Fitting Required | Easy Installation | Colour Temperature: 6000K (Daylight)

Code	Wattage	Lumen	Size (mm)
LEDT8-001A-9W-DL	9W	900lm	610 x 40 x 34
LEDT8-001A-18W-DL	18W	1800lm	1120 x 40 x 34
LEDT8-001A-2x9W-DL	2 x 9W	1800lm	610 x 84 x 34
LEDT8-001A-2x18W-DL	2 x 18W	3600lm	1120 x 84 x 34

Code (Accessories)	Description
W1023	1m Figure 8 Linking Cable

CCT Adjustable LED Battens IP20 - Input Voltage: 230VAC | Aluminium Body & PC Cover | CCT Adjustable 3000-4200-6500K

Code	Wattage	Lumen	Size (mm)
BL060-30W-CCT	30W	3000lm	600 x 75 x 27
BL120-54W-CCT	54W	5400lm	1200 x 75 x 27
BL150-72W-CCT	72W	7200lm	1500 x 75 x 27

LED Batten EMG IP20 - Input Voltage: 230VAC | Colour Temp 6500K | Battery 2 x 1.8/Ah x 2 | 3hr Backup Time | Steel Body & PC Cover

Code	Wattage	Emg. Watts	Lumens	Size (mm)
EMG-BAT-40W-DL	40W	4W	75lm/W	650 x 98 x 28

LED Linear Light - Input Voltage: 230VAC | Aluminium body with PC diffuser | c/w Mounting Screws

Code	Wattage	Lumen	Size (mm)
GJZ-F10S-20W-*	20W	2000lm	675 x 108 x 45
GJZ-F10S-40W-*	40W	4000lm	1269 x 108 x 45

*Add Colour to Code: ○ **WW** (Warm White) 3000K, ○ **CW** (Cool White) 4200K, ○ **DL** (Daylight) 6000K

LED Linear Light - Colour Temperature: 4200K (Cool White) | Linkable | CRI >70

Code	Wattage	Lumens	Size (mm)
TDL-G45017-36-CW	36W	2880lm	1200 x 65 x 35

Accessories

Code	Description
LC-1000	1m Figure 8 Linking Cable
LC-1500	1.5m Figure 8 Linking Cable

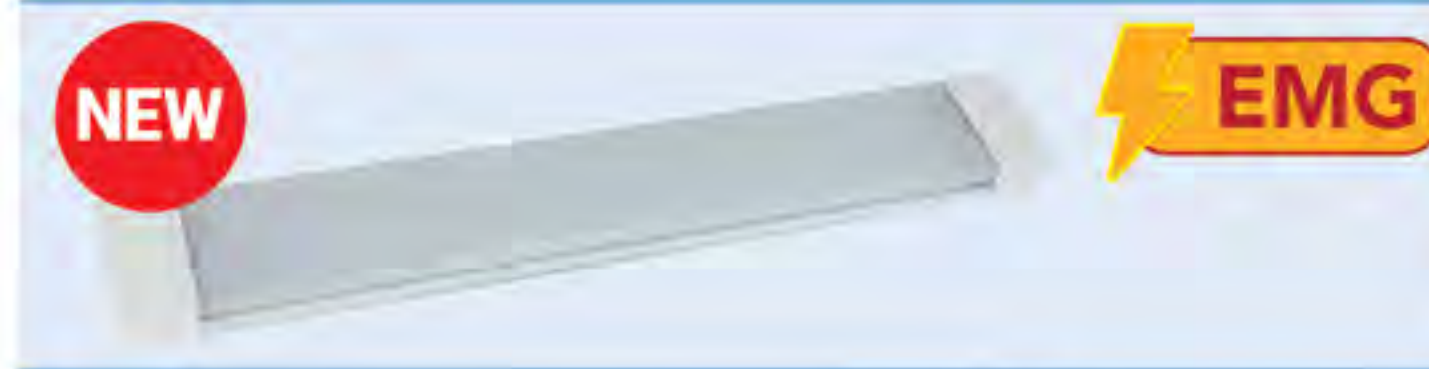

Commercial

LED BATTENS IP20

Input Voltage: 230VAC | Mild Steel Body | Two Part for easy installation | c/w Mounting Screws

Code 2 Year	Code 5 Year	Wattage	Lumen	Size (mm)
Standard Version - 100lm/W				
LG05G-06-100-20-*	LG05G-5Y-06-100-20-*	20W	2000lm	630 x 75 x 85
LG05G-12-100-40-*	LG05G-5Y-12-100-40-*	40W	4000lm	1230 x 75 x 85
LG05G-15-100-60-*	LG05G-5Y-15-100-60-*	60W	6000lm	1518 x 75 x 85

High-end Version - 125lm/W

LG05G-06-125-25-*	LG05G-5Y-125-25-*	25W	3125lm	630 x 75 x 85
LG05G-12-125-40-*	LG05G-5Y-125-40-*	40W	5000lm	1230 x 75 x 85

*Add Colour to Code: ○ **CW** (Cool White - 4000K), ○ **DL** (Day Light - 6500K)



LIGHTING

SLIM LINE LED BATTENS IP20

Ultra Slim Profile (Narrow Body) - Input Voltage: 240VAC | High transparent opal diffuser | Easy to mount | Colour Temperature: 6000K | CRI: ≥80

Code	Wattage	Lumen	Size (mm) L x W x D
DY-30-10W	10W	900lm	300 x 75 x 24
DY-60-20W	20W	1800lm	600 x 75 x 24
DY-120-40W	40W	3600lm	1200 x 75 x 24

High Power Ultra Slim Profile (Wide Body) - Input Voltage: 240VAC | High transparent opal diffuser | Easy to mount | Colour Temperature: 6500K | CRI: ≥80

OQ-XT-362	30W	2400lm	600 x 92 x 32
OQ-XT-721	72W	5760lm	1200 x 92 x 32
OQ-XT-961	96W	7680lm	1200 x 128 x 42



WALL OR CEILING LED FITTINGS IP20



Input Voltage 230VAC | 4200K (Cool White) | Aluminium with polypropylene diffuser

Code	Wattage	Lumen	Size (mm)
MB-075-LED-7W	7W	600lm	291 x 53 x 60
MB-075-LED-14W	14W	1200lm	552 x 53 x 60
MB-075-LED-21W	21W	1735lm	900 x 53 x 60
MB-075-LED-28W	28W	2380lm	1200 x 53 x 60



Adjustable

Adjustable Wall Light

Input Voltage: 230VAC | Colour Silver | Adjustable Tilt | Material: Aluminium & PC cover with ABS End Caps | Colour Temperature: 4200K

Code	Wattage	Lumen	Size (mm)
RW-551-10	10W	700lm	555 x 36 x 75

LINKABLE LED UNDERCOUNTER LIGHTING IP20



Mounting Clips

Linking with no dark spots

LED Linear Light - 230VAC - Tough plastic lens and body | Linkable c/w power cord and mounting accessories | Cool white (4000K)

Code	Wattage	Lumen	Size (mm)
RW-OC-T5-6W	6W	480-520lm	325 x 22 x 35
RW-OC-T5-10W	10W	870-920lm	586 x 22 x 35
RW-OC-T5-14W	14W	1120-1170lm	885 x 22 x 35
RW-OC-T5-18W	18W	1480-1530lm	1185 x 22 x 35



Corner Mounting LED undercounter lighting - 230VAC | 4200K (Cool White) | Linkable, c/w power cord and mounting accessories

Code	Wattage	Lumen	Size (mm)
LDL-5050-1	3W	308lm	303 x 62 x 21
LDL-5050-2	5W	528lm	441 x 62 x 21
LDL-5050-3	6W	638lm	576 x 27 x 11



Linkable High output LED undercounter lighting - 230VAC | Linkable c/w power cord and mounting accessories | Cool white (4000K) | Spare Linking Cable: RS-T5-LINK

Code	Wattage	Lumen	Size (mm)
RS-T5-18W	18W	1500lm	1200 x 24 x 30
RS-T5-24W	24W	2000lm	1500 x 24 x 30



Tiltable Wall Fluorescent Fitting - Input Voltage: 230VAC | Lamp included | Lamp body in Aluminium | Acrylic diffuser. | End covers in ABS plastic | Lamp body finished in Matt Silver. | Lamp holder can be swivelled through 180° | Standard colour: Cool White

Code	Lamp	Type	Size (mm)
MB-056-8W	8W	T5	340 x 82 x 45
MB-056-21W	21W	T5	906 x 82 x 45

T8 LED OPEN CHANNEL FITTINGS

Prewired Open Channel Fitting for T8 LED Tubes **LED Tubes & Fuse Links Excluded**



Wiring Diagram

Reflector
CZ-N3140

Lamp Power	Code (Fitting Only)				Size (mm)
	Single Lamp	Optional Reflector	Twin Lamp	Optional Reflector	
8W (2FT)	AL-A2	CZ-3120	AL-A2X2	CZ-N3220	624L x 35W x 31H
13W (3FT)	AL-A3	CZ-3130	AL-A3X2	CZ-N3230	928L x 35W x 31H
18W (4FT)	AL-A4	CZ-3140	AL-A4X2	CZ-N3240	1234L x 35W x 31H
22W (5FT)	AL-A5	CZ-3158	AL-A5X2	CZ-N3258	1534L x 35W x 31H

For LED tubes see page 1-3 | For Emergency Add Emergency Tube Code on page 3

Slimline LED T8 Fitting

Prewired for LED

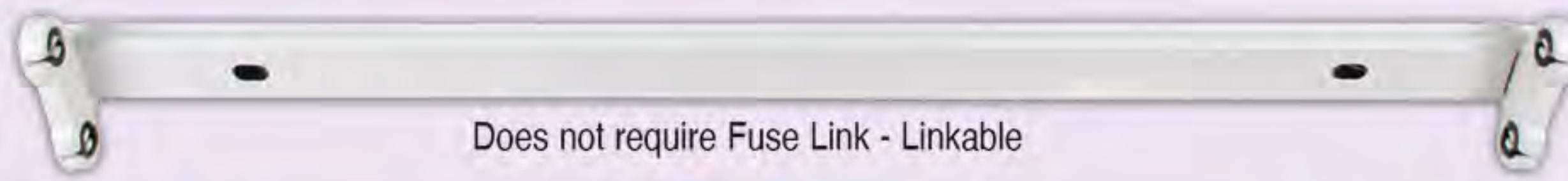

Does not require Fuse Link - Linkable

Side View

Lamp Power	Code (Fitting Only)		Size (mm)	Knock Out Size (mm)
	Single Lamp	Twin Lamp		
9W (2FT)	OS-LED-006	OS-LED-006-2	610 x 33 x 15	7 x 10
18W (4FT)	OS-LED-012	OS-LED-012-2	1210 x 33 x 15	7 x 10
22W (5FT)	OS-LED-015	OS-LED-015-2	1546 x 33 x 15	7 x 10

Accessories



LC-1500

Code	Description
LC-300	300mm Figure 8 Linking Cable
LC-1000	1m Figure 8 Linking Cable
LC-1500	1.5m Figure 8 Linking Cable

For LED tubes see page 1-3 | For Emergency Add Emergency Tube Code on page 3

T8 OPEN CHANNEL FLUORESCENT FITTINGS

Open Fluorescent Fittings

c/w P.F. Capacitor



Twin Lamp

Reflector
CZ-N3140

Narrow Fitting 50(W) x 35(H)mm

Narrow Fitting 50(W) x 35(H)mm

Lamp Power	Single Lamp					Twin Lamp				
	L (mm)	Iron Ballast	Elec. Ballast	c/w Emergency Kit	Reflector	L (mm)	Iron Ballast	Elec. Ballast	c/w Emergency Kit	Reflector
18W (2FT)	625	MF-3120	MF-3120-ELC	-	CZ-3120	630	MF-3220	MF-3220-ELC	-	CZ-N3220
30W (3FT)	930	MF-3130	MF-3130-ELC	*MF-3130-EMG	CZ-3130	932	MF-3230	MF-3230-ELC	*MF-3230-EMG	CZ-N3230
36W (4FT)	1240	MF-3140	MF-3140-ELC	*MF-3140-EMG	CZ-3140	1235	MF-3240	MF-3240-ELC	*MF-3240-EMG	CZ-N3240
58W (5FT)	1540	MF-3158	MF-3158-ELC	*MF-3158-EMG	CZ-3158	1535	MF-3258	MF-3258-ELC	*MF-3258-EMG	CZ-N3258

*1 Lamp fitted with Emergency Kit @ 11% of full power for 1 hour @ 58W
For dimmable light fitting add 'dim' to part No. eg. MF-3140-DIM.

Accessories - For spare ballasts see page 144, 146



PT-C07

PT-C02

Code	Description
PT-C07	Spare lampholder for twin-lamp fittings
PT-C02	Spare lampholder for single-lamp fittings

2-year warranty on all LED products & 1-year warranty on battery-operated products, unless specified.
LED warranty void without surge protection. Refer to page 128.

T5 OPEN CHANNEL FLUORESCENT FITTINGS

Open Fluorescent Fittings - Supplied with electronic ballasts

Double Lamp

Single Lamp



Lamp Power	Single Lamp			Twin Lamp		
	Code	c/w Emergency Kit	Size L x W x H	Code	c/w Emergency Kit	Size L x W x H
14W(2ft)	MF-5114-ELC 240V	-	579 x 50 x 70mm	MF-5214-ELC 240V	-	579 x 50 x 70mm
21W(3ft)	MF-5121-ELC 240V	-	879 x 50 x 70mm	MF-5221-ELC 240V	-	879 x 50 x 70mm
28W(4ft)	MF-5128-ELC 240V	MF-5128-EMG	1179 x 50 x 70mm	MF-5228-ELC 240V	MF-5228-EMG	1179 x 50 x 70mm
35W(5ft)	MF-5135-ELC 240V	MF-5135-EMG	1479 x 50 x 70mm	MF-5235-ELC 240V	MF-5235-EMG	1479 x 50 x 70mm
24W(2ft)	MF-5124-ELC 240V	-	579 x 50 x 70mm	MF-5224-ELC 240V	-	579 x 50 x 70mm
54W(4ft)	MF-5154-ELC 240V	MF-5154-EMG	1179 x 50 x 70mm	MF-5254-ELC 240V	-	1179 x 50 x 70mm
49W(5ft)	MF-5149-ELC 240V	MF-5149-EMG	1479 x 50 x 70mm	MF-5249-ELC 240V	MF-5249-EMG	1479 x 50 x 70mm

T8 OPEN CHANNEL FITTINGS - WIDE BODY

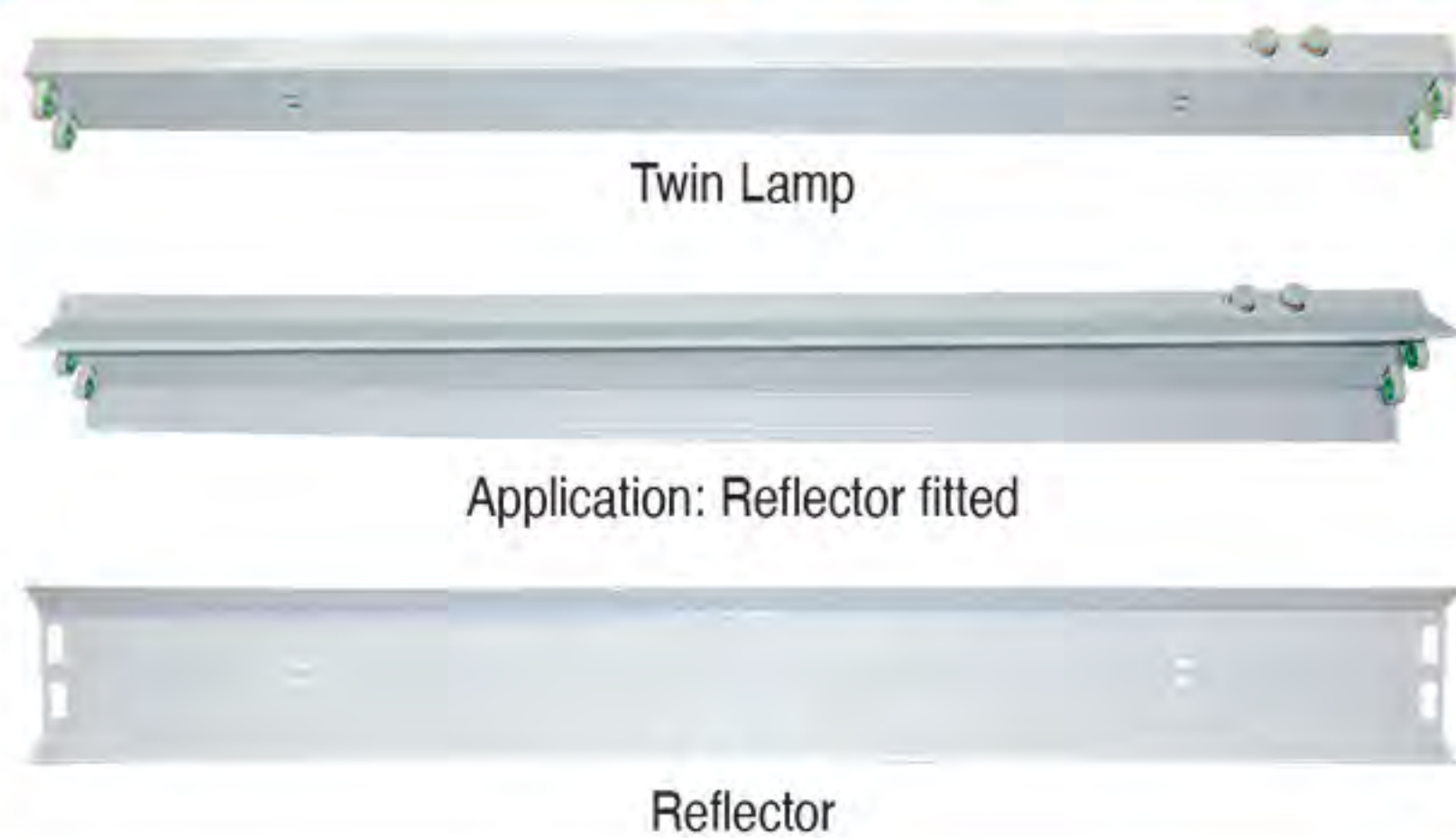

Wide Body Fittings - 100(W) x 38(H)mm

Code LED	Fluorescent			Lamp Power	L (mm)
	Iron Ballast	Elec. Ballast	Reflector		
MF-3220-WB-LED	MF-3220-WB	MF-3220-WB-ELC	CZ-3220	2x18W(2FT)	630
MF-3230-WB-LED	MF-3230-WB	MF-3230-WB-ELC	CZ-3230	2x30W(3FT)	935
MF-3240-WB-LED	MF-3240-WB	MF-3240-WB-ELC	CZ-3240	2x36W(4FT)	1240
MF-3258-WB-LED	MF-3258-WB	MF-3258-WB-ELC	CZ-3258	2x58W(5FT)	1540

TELESCOPIC OPEN CHANNEL FITTINGS



Wired for LED - Telescopic Open Channel Fitting | Telescopic Lampholders

Single Lamp LED	Wattage	Twin Lamp LED	Wattage	Size
LED-TS-1X9	9W	LED-TS-2X9	2 x 9W	2FT (677mm)
LED-TS-1X18	18W	LED-TS-2X18	2 x 18W	4FT (1277mm)
LED-TS-1X22	22W	LED-TS-2X22	2 x 22W	5FT (1577mm)

Lamps Excluded - For LED Tubes see Page 1-3

Fluorescent - Telescopic Open Channel Fitting | Telescopic Lampholders

Single Lamp	Size (mm)	Twin Lamp	Lamp Power	Size (mm)
Elec. Ballast		Elec. Ballast		
TS-6118	677 x 50 x 40	TS-6218	18W (2FT)	677 x 100 x 38
TS-6136	1277 x 50 x 40	TS-6236	36W (4FT)	1277 x 100 x 38
TS-6158	1577 x 50 x 40	TS-6258	58W (5FT)	1577 x 100 x 38

Lamps Excluded - For Fluorescent Tubes see Page 21

Accessories

Code	Description
PT-C01	Spare G13 lampholder per set

RECESSED LED DOWNLIGHTS

Dimmable

- WW - 2700K
- CW - 4200K
- PW - 5000K

5 Year Warranty



Super Slim Design IP54 - Input Voltage: 230VAC | Triac Dimmable | CRI ≥ 80 | Class II Protection | IK06 Rating | Material PC / Aluminium | Lifetime 50 000hrs | Operating Temp: -20°C - 45°C

Code	Wattage	Lumens (lm)	Cut out Size (mm)	Size (mm)	Beam Angle	*Add Colour to Code
UP-DL210-10W-*	10W	760 - 870	Ø90 - 95	Ø110 x 30	90°	WW / CW / PW
UP-DL210-13W-*	13W	1020 - 1140	Ø120 - 130	Ø145 x 30	90°	WW / CW / PW
UP-DL210-18W-*	18W	1620 - 1800	Ø160 - 170	Ø190 x 30	90°	WW / CW / PW
UP-DL210-25W-*	25W	2130 - 2380	Ø200 - 210	Ø225 x 34	90°	WW / CW / PW

- WW - 2700K
- CW - 4200K
- PW - 5000K

5 Year Warranty



Deep Reflector IP54 - Input Voltage: 230VAC | Triac Dimmable | CRI ≥ 80 | Class II Protection | IK06 Rating | Material PC / Aluminium | Lifetime 50 000hrs | Operating Temp: -20°C - 45°C

Code	Wattage	Lumens (lm)	Cut out Size (mm)	Size (mm)	Beam Angle	*Add Colour to Code
UP-DL179-10W-*	10W	700 - 800	Ø90 - 95	Ø110 x 54	80°	WW / CW / PW
UP-DL179-18W-*	18W	1600 - 1800	Ø125 - 135	Ø145 x 78	80°	WW / CW / PW
UP-DL179-25W-*	25W	2300 - 2550	Ø150 - 165	Ø172 x 90	80°	WW / CW / PW

- WW - 2700K
- CW - 4200K
- PW - 5000K

5 Year Warranty



COB High Power IP54 - Input Voltage: 230VAC | Triac Dimmable | CRI ≥ 80 | Class II Protection | IK06 Rating | Aluminium Reflector + Tempered Glass Lens | Lifetime 50 000hrs | Operating Temp: -20°C - 40°C

Code	Wattage	Lumens (lm)	Cut out Size (mm)	Size (mm)	Beam Angle	*Add Colour to Code
UP-DL229-10W-*	10W	760 - 988	Ø90 - 95	Ø110 x 35	60°	WW / CW / PW
UP-DL229-18W-S-*	18W	1500 - 1997	Ø120 - 130	Ø145 x 65	60°	WW / CW / PW
UP-DL229-18W-L-*	18W	1600 - 2066	Ø200 - 210	Ø225 x 87	60°	WW / CW / PW
UP-DL229-25W-*	25W	2200 - 2801	Ø200 - 210	Ø225 x 87	60°	WW / CW / PW
UP-DL229-42W-*	42W	3050 - 3659	Ø200 - 210	Ø225 x 87	60°	WW / CW / PW

- CW - 4200K
- PW - 5000K

5 Year Warranty



Gimble Head IP20 - Input Voltage: 230VAC | Triac Dimmable | CRI ≥ 80 | Class II Protection | IK06 Rating | PC Reflector + Tempered Glass | Lifetime 50 000hrs | Operating Temp: -20°C - 40°C

Code	Wattage	Lumens (lm)	Cut out Size (mm)	Size (mm)	*Beam Angle	*Add Colour to Code
UP-DL77-10W-*.*	10W	700 - 800	Ø85 - 90	Ø96 x 68	15, 24	CW / PW
UP-DL77-20W-*.*	20W	1840 - 2100	Ø120 - 130	Ø145 x 102	36, 60	CW / PW
UP-DL77-35W-*.*	35W	3350 - 3800	Ø165 - 170	Ø180 x 128.5	45, 60	CW / PW

- WW - 2700K
- CW - 4200K



White / Silver Trim Downlight - Input Voltage: 100-240VAC | Ultra Thin | Beam Angle 110° | Triac Dimmable

Code	Wattage	Lumens	Cut out Size (mm)	Material/ Colour	Size (mm)	*Add Colour to Code
GL-P9WA-*.*	9W	720lm	Ø135	White/Silver	145Ø x 14	WW / CW
GL-P12WA-*	12W	960lm	Ø155	Silver	170Ø x 14	WW / CW
GL-P16WA-*	16W	1280lm	Ø185	Silver	200Ø x 14	WW / CW
GL-P20WA-*	20W	1600lm	Ø210	Silver	220Ø x 14	WW / CW

*Add WH to code for white trim

- WW - 2700K
- CW - 4200K
- DL - 6000K



Glass Trim Downlight - Input Voltage: 100-240VAC | Beam Angle 110° | Triac Dimmable

Code	Wattage	Lumens	Cut out Size (mm)	Material/ Colour	Size (mm)	*Add Colour to Code
DIM-DL-RN100-6W-*	6W	400lm	Ø75	White	Ø100 x 28	WW / CW / DL
DIM-DL-RN160-12W-*	12W	800lm	Ø120	White	Ø160 x 30	WW / CW / DL

- WW - 2700K
- CW - 4200K



Input Voltage: 230VAC | Beam Angle: 90° | TRIAC Dimming

Code	Wattage	Lumens	Cut out Size (mm)	Material/ Colour	Size (mm)	*Add Colour to Code
DIM-015-6W-*	6W	510lm	Ø70	White	Ø90 x 65	WW / CW
HI-015-6W-*	6W	510lm	Ø120	White	Ø145 x 74	WW / CW
HI-015-12W-*	12W	1020lm	Ø120	White	Ø145 x 74	WW / CW
HI-015-15W-*	15W	1300lm	Ø120	White	Ø145 x 74	WW / CW

Commercial

LIGHTING

SURFACE MOUNT LED DOWNLIGHTS

Dimmable



Input Voltage: 230VAC | Aluminium | Adjustable Beam Angle: 15-60° | Triac Dimmable | Power Adjustable: 10/20/30W | Colour Temp Adjustable: 3000/4000/5000K

Code	Power Adjustable	Lumens	Cut out Size (mm)	Material/Colour	Size (mm)	Adjustable Colour Temp.
SM-DL-PW-CCT-*	10/20/30W	60lm/W	-	*W / B	Ø120 x 105	WW-CW-DL

*Add colour to code: ○ W (White), ● B (Black)



- WW - 2700K
- CW - 4200K
- DL - 6000K

Input Voltage: 230VAC | Aluminium | Beam Angle: 36° | Tilttable: 90° | Rotatable: 355°

Code	Wattage	Lumens	Cut out Size (mm)	Material/Colour	Size (mm)	*Add Colour to Code
LWQ-001-7W-**-*	7W	560lm	-	*W / B	Ø100 x 61	WW/CW/DL
LWQ-001-10W-**-*	10W	800lm	-	*W / B	Ø100 x 115	WW/CW/DL
LWQ-001-12W-**-*	12W	960lm	-	*W / B	Ø100 x 185	WW/CW/DL

Non-Dimmable



- WW - 2700K
 - CW - 4200K
- *W - White
*B - Black

Input Voltage: 185-265VAC | Aluminium | Beam Angle: 45°

COB-SM*-10W-*	10W	800lm	-	*W / B	Ø90 x 124	WW / CW
COB-SM*-20W-*	20W	1300lm	-	*W / B	Ø115 x 145	WW / CW
COB-SM*-30W-*	30W	1950lm	-	*W / B	Ø149 x 165	WW / CW

Input Voltage: 185-285VAC | Back Lit | Beam Angle: 140°



SM-RN120-6W-*	6W	420lm	-	White	Ø123 x 35	WW / CW
SM-RN170-12W-*	12W	960lm	-	White	Ø174 x 35	WW / CW
SM-RN225-18W-*	18W	1620lm	-	White	Ø226 x 35	WW / CW
SM-SQ120-6W-*	6W	420lm	-	White	122 x 122 x 35	WW / CW
SM-SQ172-12W-*	12W	960lm	-	White	173 x 173 x 35	WW / CW
SM-SQ225-18W-*	18W	1620lm	-	White	226 x 226 x 35	WW / CW

2 IN 1 SURFACE AND RECESSED LED DOWNLIGHTS

Non-Dimmable



- WW - 2700K
- CW - 4200K
- DL - 6000K

Motion & Daylight Sensor LED Panel - Input Voltage: 230VAC | Detection Height 3,5m | Hold Time 30s | Moon Mode: Both motion sensor & light sensor work when indoor illumination < 13 lux. Sun Mode: Only motion sensor works (day or night). Trim rings available in various colours.

Code	Wattage	Lumens	Cut out Size (mm)	Material/Colour	Size (mm)	*Add Colour to Code
MD-RN220-18W-*	18W	1500lm	-	White	Ø220 x 18	WW / CW / DL
MD-SQ220-18W-*	18W	1500lm	-	White	220 x 220	WW / CW / DL

Round Trim Ring Colours – MD-RN220-TR-BK (Black), MD-RN220-TR-GD (Gold), MD-RN220-TR-S (Silver)
Square Trim Ring Colours – MD-SQ220-TR-BK (Black), MD-SQ220-TR-GD (Gold), MD-SQ220-TR-S (Silver)

NEW

RECESSED/SURFACE DOWNLIGHTS

Recessed or Surface Downlights - Input Voltage: 230VAC | Beam Angle 120° | Purchase Frame to Surface Mount



Code	Wattage	Lumens	Cut out Size (mm)	Material/ Colour	Size (mm)	*Add Colour to Code
RN-WM-6W-*	6W	600lm	Ø100 - 110	White	Ø117 x 25.8	WW / CW / DL
RN-WM-9W-*	9W	900lm	Ø125 - 135	White	Ø147 x 25.8	WW / CW / DL
RN-WM-12W-*	12W	1200lm	Ø140 - 160	White	Ø167 x 25.8	WW / CW / DL
RN-WM-18W-*	18W	1850lm	Ø195 - 210	White	Ø222 x 25.8	WW / CW / DL
SQ-WM-6W-*	6W	600lm	Ø100 - 110	White	117 x 117 x 25.8	WW / CW / DL
SQ-WM-9W-*	9W	900lm	Ø125 - 135	White	147 x 147 x 25.8	WW / CW / DL
SQ-WM-12W-*	12W	1200lm	Ø140 - 160	White	167 x 167 x 25.8	WW / CW / DL
SQ-WM-18W-*	18W	1850lm	Ø195 - 210	White	222 x 222 x 25.8	WW / CW / DL

Accessories - Surface Mount Frame

Code	Description	Code	Description
RN-WM-6W-F	Round Frame 6W	SQ-WM-6W-F	Square Frame 6W
RN-WM-9W-F	Round Frame 9W	SQ-WM-9W-F	Square Frame 9W
RN-WM-12W-F	Round Frame 12W	SQ-WM-12W-F	Square Frame 12W
RN-WM-18W-F	Round Frame 18W	SQ-WM-18W-F	Square Frame 18W

RECESSED LED DOWNLIGHTS

Non-Dimmable

NEW

Frameless Downlight - Input Voltage: 185-265VAC | 110° Beam Angle | CRF >70 | Adjustable Clip for Various Hole Sizes



Code	Wattage	Lumens	Cut-out Size (mm)	Material/ Colour	Size (mm)	*Add Colour to Code
BQ-RN-9W-*	9W	900lm	Ø50-70	White	Ø85	WW / CW / DL
BQ-RN-18W-*	18W	1800lm	Ø50-100	White	Ø120	WW / CW / DL
BQ-RN-24W-*	24W	2400lm	Ø50-150	White	Ø170	WW / CW / DL
BQ-RN-36W-*	36W	3600lm	Ø50-200	White	Ø220	WW / CW / DL
BQ-SQ-9W-*	9W	900lm	750 x 70	White	85 x 85	WW / CW / DL
BQ-SQ-18W-*	18W	1800lm	100 x 100	White	120 x 120	WW / CW / DL
BQ-SQ-24W-*	24W	2400lm	150 x 150	White	170 x 170	WW / CW / DL
BQ-SQ-36W-*	36W	3600lm	200 x 200	White	220 x 220	WW / CW / DL

Commercial

- WW - 2700K
- CW - 4200K
- DL - 6000K

White Trim Downlight - Input Voltage: 185-265VAC | Black Lit | 25,5mm depth | Beam Angle 140° | CRI > 70



RW-RN120-6W-*	6W	390lm	Ø95	White	Ø118	WW / CW / DL
RW-RN150-9W-*	9W	630lm	Ø110	White	Ø145	WW / CW / DL
RW-RN170-12W-*	12W	900lm	Ø140	White	Ø175	WW / CW / DL
RW-RN200-18W-*	18W	1530lm	Ø190	White	Ø222	WW / CW / DL
RW-SQ120-6W-*	6W	420lm	95 x 95	White	120 x 120	WW / CW / DL
RW-SQ150-9W-*	9W	675lm	110 x 110	White	145 x 145	WW / CW / DL
RW-SQ170-12W-*	12W	960lm	140 x 140	White	175 x 175	WW / CW / DL
RW-SQ220-18W-*	18W	1620lm	190 x 190	White	224 x 224	WW / CW / DL

LIGHTING

- WW - 2700K
- CW - 4200K
- DL - 6000K

NEW

White Trim Emg Downlight - Input Voltage: 230VAC | RA 80 | 120° Beam Angle | 2500 mAh Li-ion Battery | Emergency Lumen: 250lm | Emergency 2-3hrs | Full Charge 6-8hrs

EMG



EMG-RW-RN180-12W-*	12W	960lm	Ø155	Pc White	Ø180 x 21	WW / CW / DL
--------------------	-----	-------	------	------------	-----------	--------------

RECESSED LED DOWNLIGHTS

- WW - 2700K
- CW - 4200K
- DL - 6000K

NEW

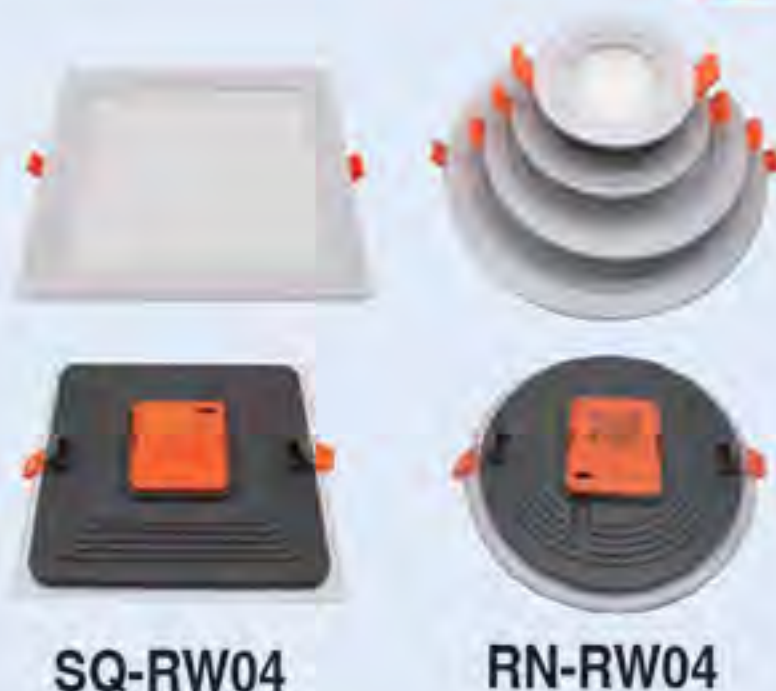

LED Panel with Integrated Driver - Input Voltage: 175-265VAC | Aluminium & Plastic | Beam Angle 110°

Code	Wattage	Lumens	Cut out Size (mm)	Material/ Colour	Size (mm)	*Add Colour to Code
RN-RW04-R6W-*	6W	300lm	Ø75	White	Ø90	WW / CW / DL
RN-RW04-R12W-*	12W	780lm	Ø100	White	Ø120	WW / CW / DL
RN-RW04-R16W-*	16W	1040lm	Ø150	White	Ø170	WW / CW / DL
RN-RW04-R24W-*	24W	1560lm	Ø200	White	Ø225	WW / CW / DL
SQ-RW04-R6W-*	6W	300lm	75 x 75	White	90 x 90	WW / CW / DL
SQ-RW04-R12W-*	12W	780lm	100 x 100	White	120 x 120	WW / CW / DL
SQ-RW04-R16W-*	16W	1040lm	150 x 150	White	170 x 170	WW / CW / DL
SQ-RW04-R24W-*	24W	1560lm	200 x 200	White	225 x 225	WW / CW / DL

- WW - 2700K
- CW - 4200K
- DL - 6000K



Glass Trim Downlight - Input Voltage: 185-265VAC | Beam Angle 110°

DL-RN100-6W-*	6W	400lm	Ø75	White	Ø100 x 28	WW / CW / DL
DL-RN160-12W-*	12W	800lm	Ø125	White	Ø160 x 32	WW / CW / DL
DL-RN200-18W-*	18W	1200lm	Ø160	White	Ø200 x 34	WW / CW / DL
DL-SQ100-6W-*	6W	400lm	65 x 75	White	100 x 100 x 14	WW / CW / DL
DL-SQ160-12W-*	12W	800lm	115 x 120	White	160 x 160 x 14	WW / CW / DL
DL-SQ200-18W-*	18W	1200lm	155 x 160	White	220 x 220 x 14	WW / CW / DL

- WW - 2700K
- CW - 4200K
- DL - 6000K



LED Recessed Downlights

Input Voltage: 185-265VAC | Aluminium | COB LED | Aluminium Reflector

RAV160-DLC10W-*	10W	900lm	Ø140	White	Ø165 x 45	WW / CW / DL
RAV190-DLC20W-*	20W	1800lm	Ø170	White	Ø195 x 58	WW / CW / DL
RAV225-DLC30W-*	30W	2880lm	Ø205	White	Ø225 x 73	WW / CW / DL

- WW - 2700K
- CW - 4200K



LED Recessed Downlights

Input Voltage: 185-265VAC | Plastic

D6002-9W-*	9W	900lm	Ø93	White	Ø108 x 52	WW / CW
D9002-15W-*	15W	1500lm	Ø120	White	Ø142 x 65	WW / CW
D9002-20W-*	20W	2000lm	Ø142	White	Ø158 x 75	WW / CW
D9002-30W-*	30W	2700lm	Ø210	White	Ø230 x 85	WW / CW
D9002-40W-*	40W	3600lm	Ø210	White	Ø230 x 85	WW / CW
D9002-50W-*	50W	4500lm	Ø210	White	Ø230 x 85	WW / CW

- WW - 2700K
- CW - 4200K
- DL - 6000K



LED Recessed Downlights

Input Voltage: 185-265VAC | Beam Angle: 180° | Plastic

PL-TD-5W-*	5W	350lm	Ø80-90	White	Ø100 x 60	CW / DL
PL-TD-12W-*	12W	840lm	Ø120-135	White	Ø146 x 80	CW / DL
PL-TD-20W-*	20W	1260lm	Ø155-170	White	Ø178 x 98	CW / DL
PL-TD-24W-CW	24W	2000lm	Ø195	White	Ø252 x 90	CW

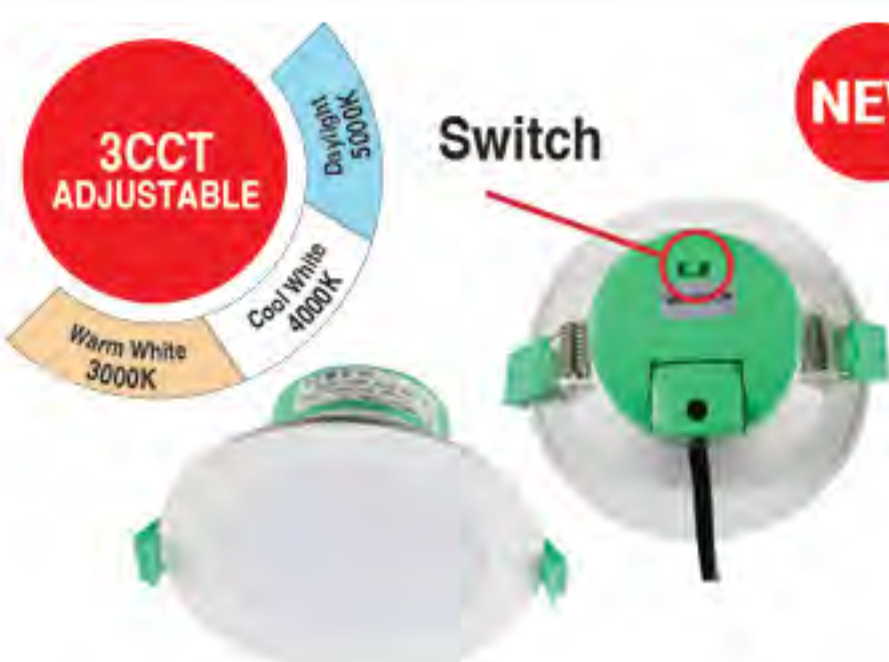

NEW

Adjustable CCT LED Light - Input Voltage: 230VAC | Switch Adjustable CCT (2700K - 4000K - 5700K) |

100° Beam Angle

DL54-CCT-10W	10W	900lm	Ø90	White	Ø115 x 60	WW + CW + DL
DL54-CCT-16W	16W	1600lm	Ø110	White	Ø140 x 65	WW + CW + DL
DL54-CCT-20W	20W	2000lm	Ø150	White	Ø190 x 70	WW + CW + DL

RECESSED LED DOWNLIGHTS

- WW - 2700K
- CW - 4200K



LED Recessed Downlights

Input Voltage: 185-265VAC | Aluminium

Code	Wattage	Lumens	Cut out Size (mm)	Material/ Colour	Size (mm)	*Add Colour to Code
TD17-140-12W-*	12W	800lm	Ø125	Satin Silver	Ø140 x 95	WW / CW
TD17-165-15W-*	15W	1000lm	Ø145	Satin Silver	Ø190 x 72	WW / CW
TD17-195-18W-*	18W	1200lm	Ø175	Satin Silver	Ø230 x 70	WW / CW

- WW - 2700K
- CW - 4200K
- DL - 6000K



LYD-BD



LYD-FD

LED Recessed Downlights

Input Voltage: 185-265VAC | Aluminium | Chrome Bezel

LYD-BD6W-*	6W	550lm	Ø110	White	Ø130 x 66	WW / CW / DL
LYD-BD12W-*	12W	1050lm	Ø145	White	Ø162 x 70	WW / CW / DL
LYD-BD18W-*	18W	1600lm	Ø165	White	Ø190 x 70	WW / CW / DL
LYD-BD24W-*	24W	2400±5%lm	Ø210	White	Ø230 x 86	WW / CW / DL
LYD-FD5W1-*	5W	500±5%lm	Ø80	White	100 x 100 x 55	WW / CW / DL
LYD-FD9W1-*	9W	900±5%lm	Ø110	White	142 x 142 x 67	WW / CW / DL
LYD-FD12W1-*	12W	1200±5%lm	Ø145	White	172 x 172 x 70	WW / CW / DL
LYD-FD15W1-*	15W	1500±5%lm	Ø145	White	172 x 172 x 70	WW / CW / DL

Non-Dimmable

- WW - 2700K
- CW - 4200K



LBS-1201-*



LBS-1202-*

Input Voltage: 185-265VAC | Aluminium

LBS-1201-*	10W	475lm	Ø78	White	Ø85 x 82	WW / CW
LBS-1202-*	10W	475lm	Ø78	White	Ø85 x 82	WW / CW

- WW - 2700K
- CW - 4200K



Input Voltage: 185-265VAC | Aluminium

COB-S190/10W-*	10W	900lm	90 x 90	White	110 x 110 x 52	WW / CW
COB-S190/20W-*	20W	2000lm	130 x 130	White	147 x 147 x 52	WW / CW
COB-S190/30W-*	30W	3000lm	160 x 160	White	180 x 180 x 52	WW / CW

- W - White
- B - Black



Input Voltage: 230VAC | Aluminium | Beam Angle: 36° | Tiltable: 90° | Rotatable: 355°

LWQ-003-12W-**-*	12W	960lm	Ø95	*W / B	Ø100 x 60	WW / CW / DL
------------------	-----	-------	-----	--------	-----------	--------------

- CW - 4200K
- DL - 6000K



Input Voltage: 185-265VAC | Recessed LED with Reflector

NED-D09W04-*	9W	680lm	Ø70	White	Ø85 x 85	CW / DL
NED-D15W04-*	15W	1100lm	Ø94	White	Ø118 x 97	CW / DL
NED-D20W04-*	20W	1500lm	Ø118	White	Ø158 x 97	CW / DL
NED-D30W04-*	30W	2150lm	Ø139	White	Ø160 x 108	CW / DL
NED-D40W04-*	40W	2800lm	Ø210	White	Ø226 x 108	CW / DL
NED-D50W04-*	50W	3500lm	Ø265	White	Ø282 x 130	CW / DL
NED-D60W04-*	60W	7200lm	Ø200	White	Ø229 x 85	CW / DL
NED-D70W04-*	70W	8400lm	Ø200	White	Ø230 x 112	CW / DL
NED-D80W04-*	80W	9000lm	Ø200	White	Ø235 x 95	CW / DL

RECESSED LED DOWNLIGHTS

- WW - 2700K
- CW - 4200K



Input Voltage: 230VAC | IP20 | Beam Angle 38° | Optional Ring for Aesthetics

Code	Wattage	Lumens	Cut out Size (mm)	Material/ Colour	Size (mm)	*Add Colour to Code
DL-B0105-**-*	5W	375lm	Ø68	*BK, WH, SN	Ø85 x 50mm	WW / CW
DL-B0107-**-*	7W	525lm	Ø68	*BK, WH, SN	Ø85 x 50mm	WW / CW

* Add Trim Colours to Code: BK (Black), WH (White), SN (Satin Nickel)

Accessories

Code	Description	*Add Colour to code
DL-B010-TRIM-*	Trim Ring for surface look	BK (Black), WH (White), SN (Satin Nickel)

- CW - 4200K



Input Voltage: 230VAC | c/w Driver | Beam Angle 30° | Glass | IP44

RWCL-3W	3W	270lm	Ø56	White	Ø70 x 66	CW
RWCL-7W	7W	630lm	Ø76	White	Ø90 x 72	CW

- WW - 2700K
- CW - 4200K



Input Voltage: 230VAC | ABS + PC | IP44

RW-RSL82-6W-*	6W	400lm	Ø65-70	White	Ø82 x 40	WW / CW
RW-SSL82-6W-*	6W	400lm	65-70	White	82 x 82 x 40	WW / CW

Colours

- CW - 4200K

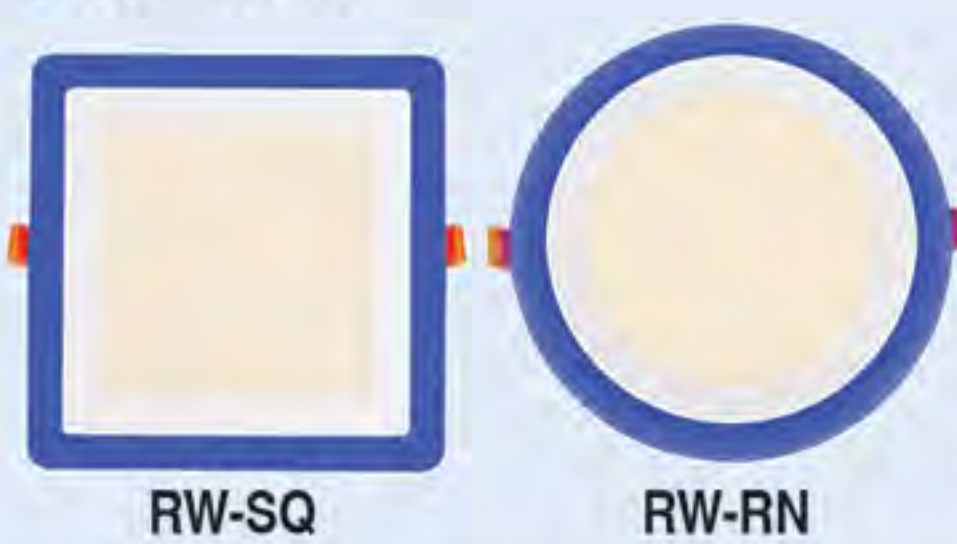

Input Voltage: 185-285VAC | Blue LED Trim | Dual Colour | Beam Angle 110°

RW-RN145-CW-BL	6 + 3W	195 + 130lm	Ø105	White	Ø145	CW
RW-RN195-CW-BL	12 + 4W	260 + 260lm	Ø155	White	Ø195	CW
RW-RN245-CW-BL	18 + 6W	390 + 390lm	Ø210	White	Ø245	CW
RW-SQ145-CW-BL	6 + 3W	195 + 130lm	105 x 105	White	145 x 145	CW
RW-SQ195-CW-BL	12 + 4W	260 + 260lm	155 x 155	White	195 x 195	CW
RW-SQ245-CW-BL	18 + 6W	390 + 390lm	210 x 210	White	245 x 245	CW

- WW - 2700K
- CW - 4200K



Input Voltage: 230VAC | Beam Angle: 20°

HI-001-1W-*	3W	70lm	Ø56	Silver	Ø69 x 69	WW / CW / ●R / ●G / ●B / ●Y
HI-001-3W-*	7W	140lm	Ø76	Silver	Ø69 x 79	WW / CW / ●R / ●G / ●B / ●Y

Input Voltage: 230VAC | Beam Angle: 30°

HI-004-9W-*	9W	420lm	Ø66	Silver	Ø75 x 109	WW / CW / ●R / ●G / ●B / ●Y
HI-007-3W-*	3W	210lm	Ø78	Silver	Ø92 x 86	WW / CW / ●R / ●G / ●B / ●Y
HI-007-9W-*	9W	420lm	Ø78	Silver	Ø92 x 121	WW / CW / ●R / ●G / ●B / ●Y
HI-010-1W-*	1W	70lm	Ø42	Silver	Ø50 x 40	WW / ●R / ●G / ●B / ●Y
HI-010-3W-*	3W	140lm	Ø42	Silver	Ø50 x 50	WW / ●R / ●G / ●B / ●Y
HI-012-1W-*	1W	70lm	Ø42	Silver	Ø55 x 37	WW / CW / ●R / ●G / ●B / ●Y
HI-012-3W-*	3W	140lm	Ø42	Silver	Ø55 x 47	WW / CW / ●R / ●G / ●B / ●Y
LED-3134-*	3W	220lm	Ø65	White	Ø79 x 27	WW / CW

- WW - 2700K
- CW - 4200K



Input Voltage: 230VAC | Beam Angle: 120°

LS0127H-*	3W	270lm	Ø75	Silver	Ø80 x 67	WW / CW / ●R / ●G / ●N / ●B / ●L / ●Y
-----------	----	-------	-----	--------	----------	---------------------------------------

- WW - 2700K
- CW - 4200K



Input Voltage: 100-240VAC | c/w LED Driver | Stainless Steel

LS0839A-*	1.5W	120lm	Ø60	Silver	Ø69 x 23	WW / CW
LS0839B-*	1.5W	120lm	60 x 60	Silver	67 x 67 x 23	WW / CW

RECESSED LED DOWNLIGHTS

Non-Dimmable



Input Voltage: 230VAC | Beam Angle: 120°

Code	Wattage	Lumens	Cut out Size (mm)	Material/ Colour	Size (mm)	*Add Colour to Code
LCM4105-RGB	15W	270lm	Ø75	Silver	Ø80 x 67	RGB

- WW - 2700K
- CW - 4200K



Input Voltage: 185-265VAC | c/w LED Driver | Plastic | Ideal for Coastal Areas

Code	Wattage	Lumens	Cut out Size (mm)	Material/ Colour	Size (mm)	*Add Colour to Code
TD60-48D-*	2.5W	240lm	Ø70	White	Ø80 x 37	WW / CW

RECESSED LED DOWNLIGHTS IP54-65

Non-Dimmable

- WW - 2700K
- CW - 4200K



Code	Wattage	Lumens	Cut out Size (mm)	Material/ Colour	Size (mm)	*Add Colour to Code
CT-3312-*	1W	90lm	Ø50	Silver	Ø77 x 24	WW / CW

Input Voltage: 12V | c/w LED Driver | Stainless Steel | IP54

Code	Wattage	Lumens	Cut out Size (mm)	Material/ Colour	Size (mm)	*Add Colour to Code
CT-3620-*	1W	130lm	Ø75	White	Ø105 x 40	WW / CW

Input Voltage: 100 - 240V | c/w LED Driver | Stainless Steel & Glass | IP54

Code	Wattage	Lumens	Cut out Size (mm)	Material/ Colour	Size (mm)	*Add Colour to Code
LED-3322A-*	3W	130lm	Ø65	Silver	Ø100 x 90	WW / CW

Input Voltage: 100 - 240V | c/w LED Driver | IP65

LED-3324A-*	3W	130lm	Ø65	Silver	90 x 90 x 90	WW / CW
-------------	----	-------	-----	--------	--------------	---------

LINEAR RECESSED LED DOWNLIGHTS

Non-Dimmable

- WW - 2700K
- CW - 4200K



Input Voltage: 185-265VAC

Code	Wattage	Lumens	Cut out Size (mm)	Material/ Colour	Size (mm)	*Add Colour to Code
LN-D001A-1-*	2W	160lm	37 x 37	Black	45 x 45 x 50	WW / CW
LN-D001A-2-*	4W	320lm	68 x 37	Black	75 x 45 x 50	WW / CW
LN-D001A-5-*	8W	640lm	140 x 37	Black	145 x 45 x 50	WW / CW
LN-D001A-10-*	18W	1440lm	273 x 37	Black	280 x 45 x 50	WW / CW
LN-D001A-15-*	24W	1420lm	405 x 37	Black	411 x 45 x 50	WW / CW

ADJUSTABLE RECESSED LED DOWNLIGHTS

Non-Dimmable

- WW - 2700K
- CW - 4200K



Input Voltage: 185-265VAC

Code	Wattage	Lumens	Cut out Size (mm)	Material/ Colour	Size (mm)	*Add Colour to Code
RW-ID20-*	20W	1600lm	220 x 130	White	230 x 146 x 86	WW / CW
RW-IN25-*	25W	2000lm	220 x 130	White	230 x 146 x 86	WW / CW
RW-IN40-*	40W	3200lm	220 x 130	White	230 x 146 x 86	WW / CW

ADJUSTABLE RECESSED LED DOWNLIGHTS

Non-Dimmable

- WW - 2700K
- CW - 4200K
- DL - 6000K

NEW



Input Voltage: 230VAC | 45° Beam Angle | Adjustable 360°

Code	Wattage	Lumens	Cut out Size (mm)	Material/Colour	Size (mm)	*Add Colour to Code
WD-GIM-7-*	7W	696lm	Ø95 x 110	White	Ø120 x 31	WW/CW/DL

- WW - 2700K
- CW - 4200K



Input Voltage: 230VAC | Beam Angle: 60° | c/w Driver

Code	Wattage	Lumens	Cut out Size (mm)	Material/Colour	Size (mm)	*Add Colour to Code
NED-D3W05B-*	3W	250lm	Ø73	White	Ø90 x 60	WW / CW
NED-D7W05B-*	7W	550lm	Ø98	White	Ø105 x 85	WW / CW
NED-D12W05B-*	12W	900lm	Ø113	White	Ø138 x 90	WW / CW

- WW - 2700K
- CW - 4200K



Input Voltage: 185-265VAC | Tilttable

Code	Wattage	Lumens	Cut out Size (mm)	Material/Colour	Size (mm)	*Add Colour to Code
CHR-090-9W-*	9W	600lm	Ø75	White	Ø95 x 66	WW / CW
CHR-090-12W-*	12W	800lm	Ø90	White	Ø110 x 72	WW / CW

- WW - 2700K
- CW - 4200K



Input Voltage: 230VAC | c/w LED Driver | Beam Angle: 30°

Code	Wattage	Lumens	Cut out Size (mm)	Material/Colour	Size (mm)	*Add Colour to Code
HI-005-3W-*	3W	210lm	Ø78	Black	Ø90 x 75	WW / CW / ●R / ●G / ●B / ●Y
HI-005-9W-*	9W	420lm	Ø78	Black	Ø90 x 119	
HI-009-3W-*	3W	210lm	Ø78	Silver	Ø90 x 75	
HI-009-9W-*	9W	420lm	Ø78	Silver	Ø90 x 119	
HI-013-1W-*	1W	70lm	Ø42	Silver	Ø55 x 37	
HI-013-3W-*	3W	140lm	Ø42	Silver	Ø55 x 47	
HI-014-3W-*	3W	210lm	Ø78	Silver	Ø92 x 86	
HI-014-9W-*	9W	420lm	Ø78	Silver	Ø92 x 121	

- WW - 2700K
- CW - 4200K



Input Voltage: 230VAC | c/w LED Driver | Beam Angle: 120°

Code	Wattage	Lumens	Cut out Size (mm)	Material/Colour	Size (mm)	*Add Colour to Code
LS0127B-*	3W	270lm	Ø75	Silver	Ø90 x 46	WW / CW / ●R / ●GN / ●BL / ●Y

- WW - 2700K
- CW - 4200K



Input Voltage: 185-265VAC | c/w LED Driver | Plastic | Ideal for Coastal Areas

Code	Wattage	Lumens	Cut out Size (mm)	Material/Colour	Size (mm)	*Add Colour to Code
TD70-60D-*	3W	285lm	Ø80	White	Ø90 x 49	WW / CW

- WW - 2700K
- CW - 4200K

IDEAL FOR COASTAL REGIONS



Input Voltage: 185-265VAC | PBT Thermal Plastic | Tilttable | Beam Angle 38° | RA80

Code	Wattage	Lumens	Cut out Size (mm)	Material/Colour	Size (mm)	*Add Colour to Code
RN-AP3-3W-*	3W	240lm	Ø60	White	Ø75 x 45	WW / CW
RN-AP3-5W-*	5W	400lm	Ø75	White	Ø90 x 45	WW / CW
RN-AP3-7W-*	7W	560lm	Ø75	White	Ø90 x 45	WW / CW
RN-AP3-10W-*	10W	800lm	Ø95	White	Ø120 x 55	WW / CW
SQ-AP3-3W-*	3W	240lm	60 x 60	White	75 x 75 x 45	WW / CW
SQ-AP3-5W-*	5W	400lm	75 x 75	White	90 x 90 x 45	WW / CW
SQ-AP3-7W-*	7W	560lm	75 x 75	White	90 x 90 x 45	WW / CW
SQ-AP3-10W-*	10W	800lm	95 x 95	White	120 x 120 x 55	WW / CW

ADJUSTABLE RECESSED LED DOWNLIGHTS

Non-Dimmable

- WW - 2700K
- CW - 4200K



Input Voltage: 185-265VAC | Aluminium

Code	Wattage	Lumens	Cut out Size (mm)	Material/ Colour	Size (mm)	*Add Colour to Code
VKC-50-*	3W	244lm	1 x Ø80	Silver	90 x 90 x 49	WW / CW
VKC-51-*	6W	450lm	2 x Ø80	Silver	175 x 90 x 50	WW / CW
VKC-52-*	9W	720lm	3 x Ø80	Silver	179 x 62 x 25	WW / CW

- WW - 2700K
- CW - 4200K



Input Voltage: 185-265VAC | Aluminium

Code	Wattage	Lumens	Cut out Size (mm)	Material/ Colour	Size (mm)	*Add Colour to Code
NED-D20-*	1 x 20W	1550lm	Ø119	Silver	135 x 135 x 93	WW / CW
NED-D40-*	2 x 20W	3000lm	238 x 119	Silver	260 x 135 x 93	WW / CW
NED-D60-*	3 x 20W	4500lm	360 x 119	Silver	382 x 135 x 93	WW / CW

- WW - 2700K
- CW - 4200K



Input Voltage: 185-265VAC | Aluminium cover & Steel Housing

Code	Wattage	Lumens	Cut out Size (mm)	Material/ Colour	Size (mm)	*Add Colour to Code
GDL6H-1R-*	1 x 7W	580lm	110 x 110	Silver	125 x 125 x 90	WW / CW / DL
GDL12H-2R-*	2 x 7W	1160lm	210 x 110	Silver	225 x 125 x 90	WW / CW / DL
GDL18H-3R-*	3 x 7W	1740lm	305 x 110	Silver	320 x 125 x 90	WW / CW / DL
GDL24HS-*	4 x 7W	2320lm	215 x 215	Silver	230 x 230 x 90	WW / CW / DL

- WW - 2700K
- CW - 4200K



Input Voltage: 185-265VAC | 2 Way Adjustable

Code	Wattage	Lumens	Cut out Size (mm)	Material/ Colour	Size (mm)	*Add Colour to Code
COB-S192/10W-*	1 x 10W	900lm	93 x 97	White	120 x 120 x 52	WW / CW
COB-S192/20W-*	2 x 10W	1800lm	188 x 97	White	215 x 120 x 52	WW / CW
COB-S192/30W-*	3 x 10W	2700lm	285 x 97	White	310 x 120 x 52	WW / CW

- WW - 2700K
- CW - 4200K



Adjustable Commercial Spotlight Fittings - Input Voltage: 230VAC | Beam Angle: 24°

Code	Wattage	Lumens	Cut out Size (mm)	Material/ Colour	Size (mm)	*Add Colour to Code
HQ-43013-*	12W	1000lm	Ø155	White	Ø162 x 120	WW / CW
TLL27-15W-*	15W	1300lm	Ø175	White	Ø190 x 180	WW / CW
RS-Q401-20W-*	20W	1400lm	Ø175	White	Ø188 x 150	WW / CW
RS-Q401-30W-*	30W	2100lm	Ø175	White	Ø188 x 150	WW / CW
8822-301-*	30W	1600lm	Ø160	White	Ø164 x 120	WW / CW
8819-302-*	30W	1600lm	160 x 160	White	168 x 168 x 180	WW / CW

2-year warranty on all LED products & 1-year warranty on battery-operated products, unless specified. LED warranty void without surge protection. Refer to page 128

DOWNLIGHTS



Aluminium Recessed Spot Lights - G4 Lamp 20W (see page 17 for LED)

Code	*Colour	Hole Size	Bezel Size
ELC-127-*	*SN, CH, WH	25mm	30mm
ELC-258-*	*SN, CH, WH	26mm	50mm

Fixed - (Zinc Alloy)

Code	*Colour	Hole Size	Bezel Size
SL-200-*	*WH, CH, SN, PB	96mm	67mm

*Add colour to code. Lamps excluded.



Steel Recessed Spot Lights - 50W

Code	*Colour	Hole Size	Bezel Size
ELC-348M-*	*SN, CH, WH	75x75mm	90x90mm

*Add colour to code. Lamp holder excluded.



Glass Recessed Spot Lights

Code	Colour	Lamp Type	Hole Size	Bezel Size
ELC-004S	Chrome/ Clear Crystal	G4-12	55mm	80mm
ELC-004C	Chrome/ Clear Crystal	JC-12	58mm	110mm
ELC-001S	Chrome/ Clear Crystal	G4-12	55mm	80mm
DT-30	Chrome/ Clear Crystal	G4-12	60mm	70mm

For LED lamps see page 17



Luxury Downlighters - Lamp holder excluded.

Code	*Colour	Hole Size	Bezel Size
D-224*	*WH, PB, CH	85mm	100mm
D-320*	*WH, PB, CH, SN	105mm	120mm

*Add colour to code

Code	Colour	Hole Size	Bezel Size
SL-009SS/G	Pearl/Gold	89mm	97mm
SL-034A	Gold	76mm	95mm
SD105-BP	Pearl/Gold	85mm	95mm

SPECIAL DOWNLIGHTS

Lamp Holder: G4 GU5.3 or GU10 see page 129	MR16	MR16	Lamp G4 12V
Code Clear D-9852B-E51	Code DG-110CR	Code DG-70/2C	Code SL-094SN
Code Blue D-9852B-E53	Description CH/ Clear Crystal	Description CH/ Clear Crystal	Stainless Steel complete with on/off switch Lamp excluded JC-12-20
Code Rose D-9852B-E52	Hole size Ø 58mm	Hole size Ø 48mm	
Hole size Ø -	Bezel Ø 110mm	Bezel Ø 70mm	
Lamp Holder: Use LED MR16 Lamp for colour effect GU5.3 or GU10 see page 129			
Code SL-222G	Code SL-005G	Code SL-048G	Code ELC-287-T
Colour Satin/Clear	Colour Satin/Clear	Colour SN/G+Clear	Colour CH/Clear Crystal
Hole Size Ø 67mm	Hole Size Ø 67mm	Hole Size Ø 65mm	Hole Size Ø 58mm
Bezel Ø 82mm	Bezel Ø 81mm	Bezel Ø 80mm	Bezel Ø 121mm
			Code ELC-2874-C4
			Colour SN/G+Clear
			Hole Size Ø 68mm
			Bezel Ø 83mm

*For MR16, order CLH202. For GU10, order LH2-ST.

2-year warranty on all LED products & 1-year warranty on battery-operated products, unless specified. LED warranty void without surge protection. Refer to page 128

DOWNLIGHTS

WH - White		BK - Black Matt finish		PB - Brass		CH - Chrome		RB - Red Antique Brass		GB - Green Antique Brass		GM - Gun Metal		SN - Satin Nickel	
Fixed (Pressed Metal)												<i>Lamp holder excluded.*</i>			
Code		*Colour		Hole Size		Bezel Size									
SL-076*		*WH, BK, PB, CH, RB, GB, SN, GM		60mm		80mm									
*Add colour to code															
Fixed (Zinc Alloy die cast)												<i>Lamp holder excluded.*</i>			
Code		*Colour		Hole Size		Bezel Size									
SL-006*		*WH, PB, GM, SN		62mm		80mm									
*Add colour to code															
Adjustable (Pressed Metal)												<i>Lamp holder excluded.*</i>			
Code		*Colour		Hole Size		Bezel Size									
SL-067*		*WH, BK, SN		73mm		82mm									
*Add colour to code															
2 Way Adjustable (Zinc Alloy die cast)												<i>Lamp holder excluded.*</i>			
Code		*Colour		Hole Size		Bezel Size									
SL-250*		*WH, BK, PB, CH, RB, GB, SN, GM, SN/G†		73mm		83mm									
*Add colour to code. †Satin Nickel with gold trim															
Fixed (Zinc Alloy die cast) GU10 Lamp no retaining clip required												<i>Lamp holder excluded.*</i>			
Code		*Colour		Hole Size		Bezel Size									
SL-025*		*WH, SN, CH, PB		73mm		82mm									
*Add colour to code															
2 Way Adjustable (Zinc Alloy die cast)															
Code		*Colour		Hole Size		Bezel Size									
SL-028*		*WH, SN, CH, PB		80mm		96mm									
*Add colour to code															
Commercial															
Code		*Colour		Hole Size		Bezel Size									
SL-203*		*WH, PB, CH, GM, SN		100mm		110mm									
SL-009*		*CH/G†, SN/N, SS/G		89mm		101mm									
*Add colour to code. †Chrome with gold trim															
Aluminium Recessed Spot Lights - 50W												<i>Lamp holder excluded.*</i>			
Code		*Colour		Hole Size		Bezel Size									
ELC-618B-*		*WH		95mm		105mm									
ELC-618C-*		*WH		95mm		105mm									
*Add colour to code															
Zink Alloy Recessed Spot Lights												<i>Lamp holder excluded.*</i>			
Code		*Colour		Hole Size		Bezel Size									
ELC-144-*		*SN, CH, WH, PB		62mm		75 x 75mm									
ELC-429-*		*SN, CH, WH, PB		75mm		82 x 82mm									
Fixed (Plastic)												<i>Lamp holder excluded.*</i>			
Code		*Colour		Hole Size		Bezel Size									
PL-076*		*WH, BK		60mm		80mm									
*Add colour to code															

*For MR16, order CLH202. For GU10, order LH2-ST.

2-year warranty on all LED products & 1-year warranty on battery-operated products, unless specified. LED warranty void without surge protection. Refer to page 128

PLASTIC DOWNLIGHTS

Plastic Downlights - Suitable for GU10 or MR16 Lamps (Lamp holder to be ordered separately, see page 129).
Ideal for Coastal Areas



Code	Colour	Cut-Out (mm)	Bezel Size (mm)
Standard Range			
DL-0175	White	Ø75	Ø88
DL-0275	White	Ø75	Ø88
DL-0375	White	Ø75	Ø90
DL-0475	White	Ø75	Ø90
DL-0575	White	Ø75	Ø90
DL-0670	White	Ø75	Ø90
DL-048080*	White/Black	75 x 75	93 x 93
DL-0480160*	White/Black	80 x 160	173 x 93
DL-0480240*	White/Black	80 x 240	252 x 93
DL-0785A	White	85 x 85	93 x 93
DL-0785B	White	85 x 85	93 x 93
DL-0885A	White	Ø85	Ø93
DL-0885B	White	Ø85	Ø93
DL-09100A*	White/Black	Surface Mount	Ø95 x 100
DL-09100A*	White/Black	Surface Mount	96 x 96 x 100

*Available Colours: ○ White, or ● Black (BK)

Anti-Glare Range			
H103T-1P-WH	White	75 x 75	90 x 90
H103T-2P-WH	White	150 x 75	167 x 90
H103T-3P-WH	White	230 x 75	245 x 90

Waterproof Downlight Fittings IP54-IP65 - Ideal for areas with water and high humidity | Max 10W LED



Code	Base	Size (mm)	Cut Out (mm)	Material
CT-3309	MR16	Ø86 x 35	Ø60	Satin Nickel
CT-3621	MR16	100 x 100 x 85	Ø75	S/Steel with Glass Trim
KFN-020-75	MR16/GU10	Ø90 x 31	Ø75	PC/White
KFN-020-8080	MR16/GU10	93 x 93 x 31	Ø75	PC/White
KFN-019-75	MR16/GU10	Ø82 x 45	Ø75	PC/White

Fixed (pressed metal) - For MR11

*Lamp holder excluded.**



Code	*Colour	Hole Size	Bezel Size
SL-078*	*SN, PB, WH 2 way tilt	55mm	68mm
SL-080*	*SN, PB, WH fixed	55mm	68mm

*Add colour to code

Aluminium Recessed Spot Lights

*Lamp holder excluded.**



SL-204

Code	*Colour	Hole Size	Bezel Size
SL-204*	*SN, CH, WH	2 x 65mm	220 x 100mm

*Add colour to code

Aluminium Recessed Spot Lights - 50W

*Lamp holder excluded.**



ELC-3390-WH

ELC-265-WH

Code	*Colour	Hole Size	Bezel Size
ELC-3390*	*SN, CH, WH	95mm	108mm
ELC-265*	*SN, CH, WH	108mm	127mm

*Add colour to code

NEW

MAGNETIC LED TRACK LIGHTS



Surface Mount Track

Code	Type	Dimensions
CY16-SUR-TR100-B	Straight	1000mm
CY16-SUR-TR200-B	Straight	2000mm
CY16-SUR-TR300-B	Straight	3000mm
CY16-SUR-ARC80Q-B	Quarter Curve	1/4 of Ø800mm
CY16-SUR-ARC100Q-B	Quarter Curve	1/4 of Ø1000mm
CY16-SUR-ARC120Q-B	Quarter Curve	1/4 of Ø1200mm
CY16-SUR-ARC80H-B	Half Curve	1/2 of Ø800mm
CY16-SUR-ARC100H-B	Half Curve	1/2 of Ø1000mm
CY16-SUR-ARC120H-B	Half Curve	1/2 of Ø1200mm
CY16-SUR-HOR-B	Horizontal Track	40 x 40mm
CY16-SUR-VER-B	Vertical Track	100 x 100mm

Track Adaptors

CY16-FJ02-B	2 Directions (15°)	120 x 50mm
CY16-FJ03-B	3 Directions (15°)	120 x 80 x 50mm
CY16-FJ04-B	4 Directions (15°)	120 x 120 x 50mm
CY16-TR-CON-B	Rigid Straight	144 x 17 x 19mm
CY16-ARC-CON-B	Arc Track Connector	50.5 x 16 x 17mm

Track Power Adaptors

CY16-30CON	Straight Track 4 Wire (LN+Signal)	104 x 17 x 19mm
CY16-ARC-200CON	Curve Track 4 Wire (LN+Signal)	50.5 x 16 x 17mm
CY16-BI-DR100	DC48V, 80W, AC176-264V	280 x 22.2 x 49.5mm
CY16-BI-DR200	DC48V, 150W, AC176-264V	280 x 22.2 x 49.5mm

Track Luminaires IP20 - Straight Matt Black | CRI 90 | Die-cast Aluminium



Code	Wattage	Lumens	Beam Angle	Dimensions
CY16-L300-B*	7W	420lm	120°	302 x 17 x 42mm
CY16-LR12-B*	12W	840lm	36°	255 x 17 x 42mm
CY16-AR12-B*	12W	840lm	36°	254 x 17 x 102mm
CY16-S11-B*	11W	800lm	36°	Ø50 x 86mm
CY16-ARC-S02-B*	2W	100lm	36°	50 x 17 x 55mm
CY16-ARC-11-B*	11W	800lm	36°	Ø50 x 145mm

*Add colour to code: ○ **WW** (Warm White) 3200K, ○ **CW** (Cool White) 4200K, ○ **DL** (Daylight) 6000K

FLEXIBLE TRACK LIGHT SYSTEM



Flexible Track Light Kit - Input Voltage: 230VAC

Code	Description
LT-FT5094-4PA	2m Flexible Track Light Kit with - 1 x Floating Canopy - 4 x Rail Supports - 4 x GU10 Track Heads - Middle Connector to join tracks

2-year warranty on all LED products & 1-year warranty on battery-operated products, unless specified. LED warranty void without surge protection. Refer to page 128

2 WIRE LED TRACK LIGHTS

○ WW - 2700K
○ CW - 4200K



Standard LED Track Head - Input Voltage: 230VAC | CRI > 80

Code	Wattage	Beam Angle	Lumens	Size (mm)	* Add Colour Temp to Code
TLL19-9W-*.*	9W	Fixed 24°	850lm	Ø60 x 90	WW / CW
TLL19-12W-*.*	12W	Fixed 30°	1100lm	Ø90 x 120	WW / CW
8611-311-*.*	30W	Fixed 24°	1600lm	Ø80 x 140	WW / CW
GDD-002-*.*	7W	36°	490lm	Ø47 x 150	WW / CW
371-X2G-*.*	7W x 2	15°	700lm x 2	120 x 125 x 142	WW / CW
GD15A-40-*.*	40W	15°	3200lm	140 x 100 x 230	WW / CW
GD01-H07C-*.*	7W	24°	560lm	100 x 55 x 110	WW / CW

*Add colour to code: ○ WH (White), ● BK (Black)

*Add colour to code: ○ W (White), ● B (Black)

○ WW - 2700K
○ CW - 4200K



Commercial LED Track Head - Input Voltage: 220-240VAC | CRI > 80

Code	Wattage	Beam Angle	Lumens	Size (mm)	* Add Colour Temp to Code
XH-TL-15W-F-*.*	15W	24°	1400lm	60 x 77 x 229	WW / CW
XH-TL-25W-F-*.*	25W	24°	2100lm	71 x 88 x 249	WW / CW
XH-TL-35W-F-*.*	35W	24°	3040lm	83 x 100 x 252	WW / CW
XH-TL-10W-B-*.*	10W	40°	830lm	114 x 172 x 75	WW / CW
XH-TL-20W-B-*.*	20W	40°	1680lm	132 x 177 x 75	WW / CW
XH-TL-30W-B-*.*	30W	40°	2600lm	144 x 180 x 75	WW / CW
XH-TL-15W-E-*.*	15W	15° - 50°	1200-1400lm	Ø62 x 150	WW / CW
XH-TL-25W-E-*.*	25W	15° - 50°	1900-2100lm	Ø90 x 197	WW / CW
XH-TL-35W-E-*.*	35W	15° - 50°	3040-3550lm	Ø90 x 197	WW / CW
XH-TL-45W-E-*.*	45W	60°	4100lm	226 x 248 x 40	WW / CW

*Add colour to code: ○ W (White), ● B (Black)

○ WW - 2700K
○ CW - 4200K



Linear LED Track Head - Input Voltage: 230VAC | CRI > 80

Code	Wattage	Beam Angle	Lumens	Size (mm)	* Add Colour Temp to Code
LX-LT-10W-*.*	10W	110°	1300lm	300	WW / CW
LX-LT-20W-*.*	20W	110°	2600lm	600	WW / CW
LX-LT-30W-*.*	30W	110°	3900lm	1000	WW / CW



Adjustable LED Track Head - Input Voltage: 230VAC | Tilttable: 90° | Rotatable: 355°

Code	Wattage	Beam Angle	Lumens	Size (mm)	* Add Colour Temp to Code
LWQ-002-7W-*.*	7W	36°	490lm	Ø100 x 61	WW / CW
LWQ-002-10W-*.*	10W	36°	800lm	Ø100 x 115	WW / CW
LWQ-002-12W-*.*	12W	36°	900lm	Ø100 x 185	WW / CW

*Add colour to code: ○ W (White), ● B (Black)

LWQ-068-*.*	7W	36°	560lm	Ø40 x 260	WW / CW
-------------	----	-----	-------	-----------	---------

*Add colour to code: ○ W (White), ● B (Black)

○ WW - 2700K
○ CW - 4200K



3CCT Adjustable Track Light Head - Input Voltage: 230VAC | CRI 90 | Dimmable 10-100% | 36° Beam Angle | Colour Temperature Adjustable: 3000K-4000K-5000K Switchable

Code	Wattage	Beam Angle	Lumens	Size (mm)	Colour Temp. Adj.
CCT-TL-20W-*.*	20W	36°	2000lm	Ø76 x 139	WW + CW + DL

*Add colour to code: ○ W (White), ● B (Black)

TRACK LIGHT & ACCESSORIES

Track Lighting - Track supplied with End Cap and Power End Cap					Spare End Cap & Power End Cap		
Code 2 Wire	YD-2C- [*] - ^{**}				YD-E-2- [*]	KTK-V	
Code 3 Wire		YD-3C- [*] - ^{**}			2-Wire		
Code 4 Wire			YD-4C- [*] - ^{**}			YD-E-3- [*]	YD-F-3- [*]
*Add to code: length (meter) 1, 2 or 3. **Add colour to code: ○ W (White), ● B (Black)							
Track Lighting - Track supplied with End Cap and Power End Cap					Spare End Cap & Power End Cap		
Code 2 Wire	KTK-I	KTK-L	KTK-T	KTK-X	YD-E-2- [*]	KTK-V	
Code 3 Wire	YD-I-3- [*]	YD-L-3- [*]	YD-T-3- [*]	YD-X-3- [*]	YD-E-3- [*]	YD-F-3- [*]	
Code 4 Wire	YD-I-4- [*]	YD-L-4- [*]	YD-T-4- [*]	YD-X-4- [*]	YD-E-4- [*]	YD-F-4- [*]	
*Add colour to code: ○ W (White), ● B (Black).					*Add colour to code: ○ W (White), ● B (Black).		
Track Light Fitting & Pendant Adaptors - Universal Adaptors to modify existing tracks to heads Pendant track adaptors allow pendants to wire to adaptor							
Code 2 Wire	201- [*]	202- [*]	203- [*]				
Code 3 Wire				301- [*]	302- [*]		
Code 4 Wire						401- [*] 402- [*]	
*Add colour to code: ○ W (White), ● B (Black)							

MINI LED TRACK & DISPLAY CABINET LIGHTS

Track - Can be cut to length	Connectors				Fixing Clip	
Code	TT-1000	TT-23	TT-24	TT-25	TT-27	TT-37M
Size (mm)	1000 x 11.8 x 9.6H	50	31 x 31H	50 x 31 x 31H	31 x 31 x 31H	12 x 12 x 15H
Description	Track 1m	Straight	L Corner	T Connector	3D Connector	Clip
Live / Dead Ends	End Caps				End Caps	
Code	TT-38C	TT-38D	TT-38	TT-DE1	TT-ECL	TT-ECR
Description	Corner Live	Corner Dead End	Live End	Dead End	End Cap Left	End Cap Right
Heads - Adjustable, Beam Angle 15°	Strips - Beam Angle 15°		LED Cabinet Lights - Supply Voltage: 110 - 240VAC			
Code	TT-32- [*]	TT-31- [*]	TT-S250- [*]	TT-S500- [*]	LUA2411-1	LUA2411-3
Wattage	1W	1W	9W	9W	1W	3W
Lumens	100lm	100lm	900lm	900lm	90lm	250lm
Size (mm)	Ø31 x 63	Ø18 x 60	250 x 12H	500 x 12H	75 x 19 x 250	68 x 20 x 250
*Add colour to code: ○ WW (Warm White) 3000K, ○ CW (Cool White) 4000K						

2-year warranty on all LED products & 1-year warranty on battery-operated products, unless specified.
LED warranty void without surge protection. Refer to page 128

NEW

LED DOWNLIGHT / CABINET LIGHTS

Supply Voltage:
230VAC



Code	LCS0210R-1-*	LCS0210S-1-*	LCS0310R-1-*	LCS0320R-3-*	LCS0420R-3-*
Power	1W	1W	1W	3W	3W
Lumen	85lm	85lm	85lm	255lm	255lm
Size (mm)	Ø30 x 22	30 x 30 x 22	Ø35 x 25	Ø40 x 25	Ø40 x 25
Cut Out Size (mm)	Ø27	27 x 27	Ø25	Ø30	Ø35

Supply Voltage:
230VAC



Code	LCS0420S-3-*	LCS0420Q-3-*	LCS0420H-3-*	LCS0420A-3-*	LCS0820R-3-*
Power	3W	3W	3W	3W	3W
Lumen	255lm	255lm	255lm	255lm	255lm
Size (mm)	40 x 40 x 25	Ø40 x 25	44 x 44 x 30	Ø44 x 30	Ø55 x 42
Cut Out Size (mm)	35 x 35	Ø35	35 x 35	Ø35	Ø43



Code	LCS0820S-3-*	LCS1425R-3-*	LCS1425R-5-*	LCS1425S-3-*	LCS1425S-5-*
Power	3W	3W	5W	3W	5W
Lumen	255lm	255lm	425lm	255lm	425lm
Size (mm)	55 x 55 x 42	Ø50 x 55	Ø50 x 62	50 x 50 x 55	50 x 50 x 62
Cut Out Size (mm)	43 x 43	Ø42	Ø42	42 x 42	42 x 42

*Add colour to code: ○ WW (Warm White) 3000K, ○ CW (Cool White) 4200K

Supply Voltage:
230V/50Hz.
Constant current
driver to be ordered
separately
CLD-B3503 (pg 888)



Code	QL201B20-*	QL101B11-*	LWQ-009-*	QL102B02-*	QL103B32-*
Power	1W	1W	12W	1W	1W
Lumen	83lm	83lm	240lm	83lm	83lm
Size (mm)	Ø52	Ø52	Ø41 x 89	Ø41.5	Ø41.5
Cut Out Size (mm)	Ø42	Ø42	Ø35	Ø35	Ø35

*Add LED colour to code: ○ WW (Warm White) 2700K, ○ CW (Cool White) 4200K, ● BL (Blue), ● Y (Yellow), ● GN (Green), ● R (Red)

Mini Aluminium LED Downlights

Supply Voltage:
230V/50Hz.
Constant current
driver to be ordered
separately
CLD-B3503 (pg 888)

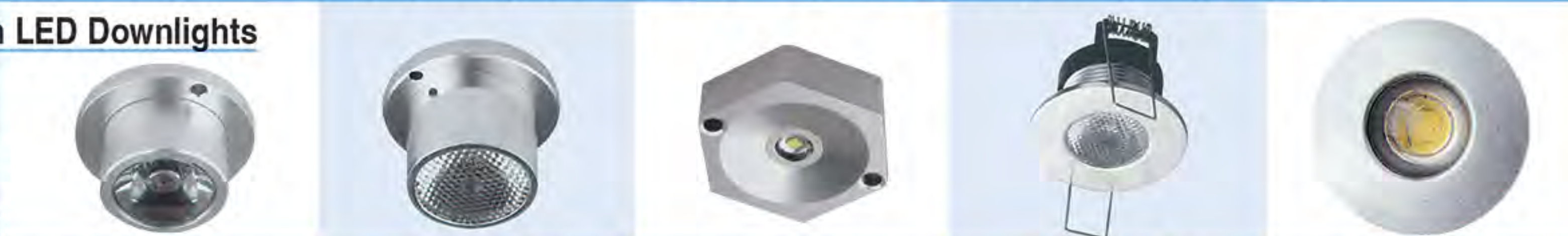





Code	EL212003-*	EL212004-*	EL212005-*	EL202732-B-*	EL212007-*
LED	1W (350mA)	1W (350mA)	1W (350mA)	1W (700mA)	1W (350mA)
Req PSU	CLD-B3503	CLD-B3503	CLD-B3503	LED-N12-9W	CLD-B3503
Size (mm)	Ø23.5 x 16.5	Ø23.5 x 16.5	Ø30 x 9	Ø49	Ø30
Cut-out Size (mm)	-	-	-	Ø40	Ø24

*Add LED colour to code: ○ W (Cool White) 4200K, ● BL (Blue), ● Y (Yellow), ● GN (Green), ● R (Red)



Commercial

LIGHTING

LED CABINET LIGHTS

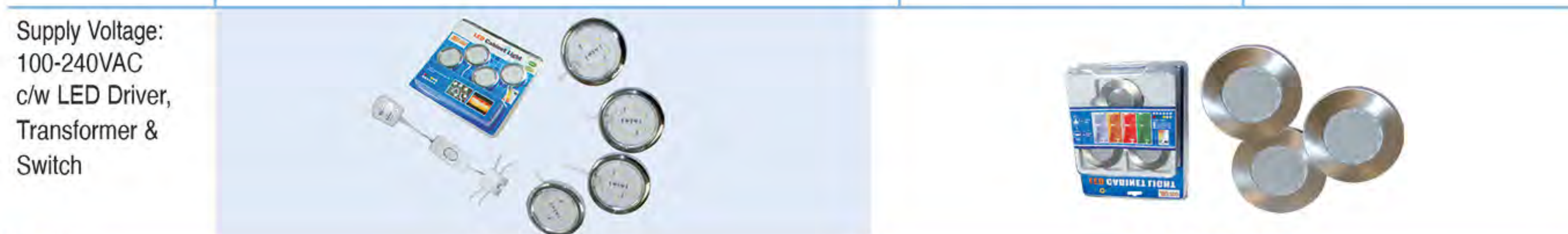
	12VDC 	12VDC 	 c/w Driver	Supply Voltage: 230V/50Hz c/w LED Driver 
Code	EL202744-*	EL200867-*	LS0841-1-*	LED-3199-*
LED	1.2W	0.5W	3W	3W
Req PSU	12V	12V	Included	Included
Size (mm)	Ø60 x 9	Ø40	Ø57 x 7.5	Ø44 x 45
Cut-out Size (mm)	-	Ø34	-	-
*Add LED colour to code	○ W (Cool White) 4200K, ● BL (Blue), ● Y (Yellow), ● GN (Green), ● R (Red)		○ CW (Cool White) 4200K, ● BL (Blue), ● Y (Yellow), ● GN (Green), ● R (Red)	○ WW (Warm White) 2700K, ○ CW (Cool White) 4200K



Supply Voltage: 100-240VAC c/w LED Driver, Transformer & Switch		
Code	LS0834-WW	LS0839A-KIT-*
Wattage	3W x 4	28.5W x 3
Lumens	40lm x 4	120lm x 3
Size	Ø75 x 4H	Ø69 x 23H
IP Rating	IP20	IP20

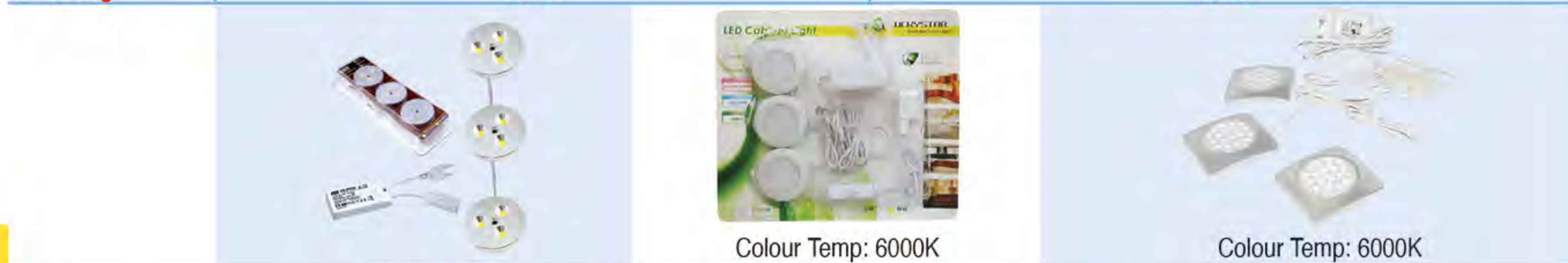

		 Colour Temp: 6000K	 Colour Temp: 6000K
Code	LS0841-3-*	LS-CG2301YM-3-PW	LS-CG2301FM-3-PW
Wattage	3W x 3	1.5W x 3	1.5W x 3
Lumens	148lm x 3	80lm	80lm
Size	Ø57 x 7.5H	Ø65 x 15	75 x 75 x 20
IP Rating	IP20	IP20	IP20



Code	QL-6022A-*	QL-6023A-*	QL-6025A-*
Size (mm)	239L x 51.5W x 29H	360L x 51.5W x 29H	605L x 51.5W x 29H
Lumen	120lm	180lm	300lm
Watts	2 x 1W	3 x 1W	5 x 1W

*Add colour to code: ○ WW (Warm White) 2700K, ○ CW (Cool White) 4200K

Commercial

LIGHTING

LED HINGE LIGHT

			Code	CHL-A49A/2	CH-A04/2
CHL-A49A/2	CH-A04/2	Installed	Lumens	16lm	
			Integrated	On / Off	
			Sensor	Trigger	
			Operating Voltage	12V	
			Application	Cupboards	
			Spare Battery	AC531	
					Soft Close Hinge (Set of 2)

2-year warranty on all LED products & 1-year warranty on battery-operated products, unless specified. LED warranty void without surge protection. Refer to page 128

CABINET LIGHTS



230VAC



Power Supply

Portable Makeup Light IP40 - Input Voltage: 5VDC USB
 | 3 Level Touch Dimming | RA > 80 | Colour Temperature:
 6000K | Mounting Suction Cup Included

Code	Wattage	Lumens	Size (mm)
PI4A1CH	4W	180lm	Ø14 x 206

Complete with Power Supply 230VAC / 5VDC



230VAC
 CW - 4200K
 DL - 6500K



Power Supply

Smart Sensor Light - Auto On & Off IP20 - Input
 Voltage: 5VDC | PIR & Daylight Sensor | Sensing Distance
 > 3m | Adjustable Time Delay | Colour Temperature: 6000K |
 Magnetic Mounting Strip Included

Code	Wattage	Lumens	Size (mm)
M3062CH-DL	4W	180lm	315 x 60 x 30

Complete with Power Supply 230VAC / 5VDC



230VAC
 CW - 4200K
 DL - 6500K



Power Supply

Smart PIR Cabinet Light IP20 - Input Voltage 100 -
 240VAC | PIR Sensor | Sensing Distance < 3m | 2 Minute
 Delay Off | Colour Temperature: 6000K | Mounting Kit Included

Code	Wattage	Lumens	Size (mm)
M45A1CH-DL	11W	850lm	450 x 39 x 10

Complete with Power Supply 230VAC / 5VDC



5VDC USB



Charger

Mini Drawer LED Light - Rechargeable 330mAh Lithium
 Battery | Input Voltage: 5V (USB) | Colour Temperature: 6000K
 | Auto On/Off | Very Small, Portable & Easy to Install | Magnetic
 Mounting Kit Included

Code	Wattage	Lumens	Size (mm)
MMSL1/2	0.6W	36lm	68 x 28 x 11

Complete with USB Cable



5VDC USB



Charger

Rechargeable PIR Cabinet Light IP20 - Beam Angle 120°
 | Battery Capacity 1200mAh | PIR Sensor | Switch Mode: Left -
 off, Right - manual mode, Middle - PIR | 12 Second Delay Off |
 Colour Temperature: 6000K | Mounting Kit Included

Code	Wattage	Lumens	Size (mm)
M80P2CH	2W	150lm	Ø80 x 28.5

Complete with USB Cable



Battery Operated

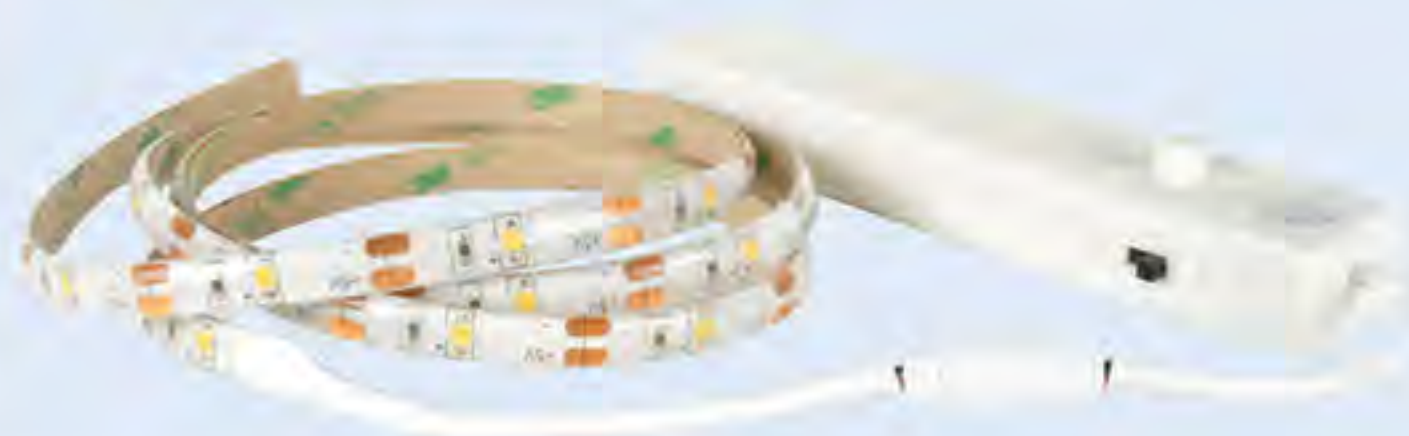

Battery Operated PIR Wardrobe Light IP20 - 4 x AAA
 Battery (Not Included) | PIR Sensor | Sensing Distance 2m |
 Switch Mode: Upwards - PIR, Downwards - Manual Mode |
 12 Second Delay Off | Colour Temperature: 4000K | Mounting
 Tape Included

Code	Wattage	Lumens	Strip Size (mm)
M21M1CH	2.4W	200lm	1000 x 8 x 2.3



Battery Operated

NEW



LED Rechargeable PIR Wardrobe Light IP20 -
 1m Length LED Strip | Controller size: 112 x 35 x 26.5mm |
 Li-Battery, 1500MAh | PIR Sensor | Sensing Distance:
 2.5m | Function: Motion Sensor or Switch | Charging Time:
 2-3hrs | >3hrs Working Time | Colour Temperature: 4000K |
 Accessories: 1m USB Charge Cable

Code	Wattage	Lumens	Strip Size (mm)
M21M1CH-R	2.4W	200lm	1000 x 8 x 2.3

2-year warranty on all LED products & 1-year warranty on battery-operated products, unless specified.
 LED warranty void without surge protection. Refer to page 128

RECHARGEABLE CABINET LIGHTS



5VDC USB



Charger

Rechargeable PIR Wardrobe Light - Battery Capacity 900mAh | PIR Sensor | Sensing Distance 2m | Switch Mode: Left - PIR, Right - Manual, Middle - Off | Colour Temperature: 4000K | **IP20** | Magnetic Mounting Kit Included

Code	Wattage	Lumens	Size (mm)
M33A1GB	1.5W	120lm	330 x 345 x 15

Complete with USB Cable



5VDC USB

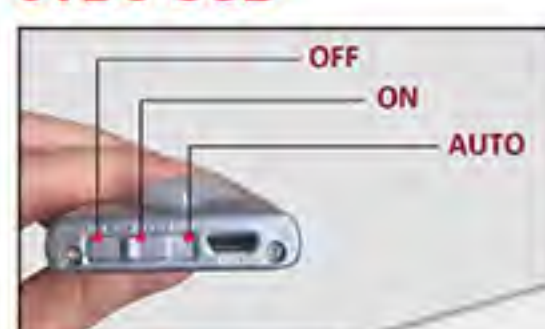

Ultra Slim Cabinet Light - 5V USB Charging | Alluminium Alloy | **IP20** | c/w Built-in Magnet for Easy Mounting, Mounting Clips & USB Charging Cable | Colour Temp: 4200K | c/w Motion Sensor

Code	Wattage	Lumens	Battery	Size (mm)
DL-6110-23	1.4W	140lm	900mAh	230 x 40 x 9
DL-6110-40	3W	300lm	1500mAh	400 x 40 x 9
DL-6110-60	3.2W	320lm	2000mAh	600 x 40 x 9

NEW



LED Linear T5 Rechargeable Lamp IP20 - 5VDC USB Charging | Battery Capacity: 4W - 1x1.8Ah, 6W - 2x1.8Ah | Charging Time: 4W - 2hrs, 6W - 4hrs | Working Time: 4W - 1hr Full Power & 2hrs Half Power, 6W - 2hrs Full Power & 4hrs Half Power | 3 Working Modes: Full Power, Half Power, Flashing | Colour Temp: 8000K | Beam Angle: 120° | Magnetic Mounting Kit included

Code	Wattage	Lumens	Size (mm)
JCL-T5-901-4W	4W	400lm	320 x 40 x 23
JCL-T5-901-6W	6W	600lm	540 x 40 x 23

BATTERY OPERATED CABINET LIGHTS



Cupboard & Wardrobe Light - Battery Operated Linear Light | Integrated 6 SMD LED's | 4000K | Integrated On/Auto/Off Switch | Magnet Operated | 6 x AA Batteries (Not Included) | c/w Mounting Bracket and Screws.

Code	Wattage	Lumens	Size (mm)
BOCL02W	2W	130lm	400 x 43 x 27



Drawer Light - Battery Operated Linear Light | Integrated 3 SMD LED's | 4000K | On/Off Switch Magnet Operated | 3 x AA Batteries (Not Included) | c/w Mounting Bracket and Screws.

Code	Wattage	Lumens	Size (mm)
BOCL03W	3W	150lm	250 x 44 x 27



Counter Top & Wardrobe Light - Battery Operated Linear Light | Integrated 12 SMD LED's | Integrated On/Off Switch | Magnet Operated | 12 x AA Batteries (Not Included) | c/w Mounting Kit and Screws.

Code	Wattage	Lumens	Size (mm)
BOCL01W	4W	260lm	465 x 58 x 27



Ceiling Light - Battery Operated Spot Light | Integrated 9 SMD LED's | 4000K | On/Off Operated and push front cover | 4 x C Batteries (Not Included) | c/w Mounting Kit and Screws

Code	Wattage	Lumens	Size (mm)
BOCL05W	3W	150lm	Ø144 x 43



Ceiling Light - Battery Operated Spot Light | Integrated 1 SMD LED | 4000K | Light & Motion Sensor with On/Auto/Off Switch | 3 x AA Batteries (Not Included) | c/w Mounting Kit and Screws.

Code	Wattage	Lumens	Size (mm)
BOCL04W*	4W	260lm	Ø96 x 30

* For a set of 3 add /3 to code

LED UNDERCOUNTER / CABINET LIGHTS

Low Profile LED undercounter Lighting

Supply Voltage : 12VDC. Power Supply excluded



Features

- Polycarbonate lens and aluminium body
- Linkable, c/w power cord and mounting accessories
- 30 000 hours average lifespan
- Max length in series 1.5m
- Cool White (4000K)
- For DC power supply see page 39-40.



Touch Switch



S02-PD

On/Off Switch
Dimming

Cupboard Door Switch



S02-IR

Photo-electric Sensor
Used on doors
Light will switch on when door opens

Motion Sensor Switch



S02-PR

PIR Motion Sensor
Distance 1-3m
Time Delay 1min/5min
Selectable

Code	Size (mm)	Power	No. of LED's	LED Type	Lumen	Spare Link
L500S25	500 x 25 x 9	5W	72	3528 SMD	475lm	S25-LINK
L800S25	800 x 25 x 9	8.5W	120	3528 SMD	760lm	

Low Profile LED undercounter Lighting

For corner application

Supply Voltage : 12VDC. Power Supply excluded



Features

- Polycarbonate lens and aluminium body
- Linkable, c/w power cord and mounting accessories
- 30 000 hours average lifespan
- Max length in series 1.5m
- Cool White (4000K)
- For DC power supply see page 39-40.



Code	Size (mm)	Power	No. of LED's	LED Type	Lumen	Spare Link
L300T27	300 x 27 x 11	3W	42	3528 SMD	292lm	T27-LINK
L500T27	500 x 27 x 11	5W	72	3528 SMD	475lm	
L800T27	800 x 27 x 11	8.5W	120	3528 SMD	760lm	
L1000T27	1000 x 27 x 11	10.5W	144	3528 SMD	880lm	

LED DC LIGHT FITTINGS

Code	C2-83	C2-94	C2-147	C2-59C	C2-146	
LED Colour	Warm White	White	White	White	White	
Watts	1.5W	1.5W	1.5W	1.5W	1.5W	
Volts	12-24VDC	12-24VDC	12-24VDC	12-24VDC	12-24VDC	
Size (mm)	Ø80 x 45	Ø80 x 48	Ø78 x 29	139 x 92 x 21	139 x 92.5 x 21	
Control	Built in rocker switch On-Off control 350° swivel/40° angle adjustment		Built in rocker switch On-Off control	Built in rocker switch On-Off control	Built in rocker switch On-Off control	
Code	C2-103	C2-138	C2-123-CL2*	C2-123-CL4*	C2-64CAL	C2-613
LED Colour	White	Cool White	Pure White	Pure White	White	White
Watts	3W	4(4 x 1W)	2(2 x 1W)	4(4 x 1W)	1.2(4 x 0.5W)	3(10 x 0.3W)
Volts	12-24VDC	9-30VDC	9-32VDC	9-32VDC	12-24VDC	12VDC
Size (mm)	250 x 87 x 35	249 x 108 x 31	95 x 30 x 33	275 x 30 x 33	187 x 30 x 30	230 x 24 x 11
Control		Built in rocker switch On-Night-Off or On-Off	180° Pivot. Built in rocker switch for On-Off	180° Pivot. Built in rocker switch for On-Off	180° Pivot. Built in rocker switch for On-Off	

*Add fitting colour to code: ○W (White), ●BK (Black)

LED INTERIOR DC LIGHTING

Light Colour:
White
Supply Voltage:
9-33VDC



Code	C2-212	C2-217	C2-220
No. of LED's	42 x SMD	68 x SMD	64 x SMD
Watts	3W	4W	4W
Size (mm)	Ø130 x 12	Ø180 x 12	185 x 150 x 12
Control	Touch Control (On-Dimmer-Off)		

DC Fluorescent Light Fittings - For battery installations eg. caravans etc.

Lamp included
Cool White
4000K



Code	C2-76 12V	C2-78 12V	C2-89 12V-LED	C2-92 12V	C2-91 12V
Code	C2-76 24V	C2-78 24V	C2-89 24V-LED	C2-92 24V	
Lamp Type	T5	T5	LED	T8	T5
Watts	1 x 8W (FLT5-8)	2 x 8W (FLT5-8)	0,5W x 18Pcs	1 x 15W (FLT8-15)	1 x 8W (FLT5-8)
Size (mm)	410 x 68 x 35	411 x 68 x 35	485 x 65 x 45	591 x 65 x 45	340 x 50 x 28
Fitting Colour	White	White	Satin	Satin	White
Control	Rocker switch, On-Off				

Lamp included
Cool White
4000K



Code	C2-68 12V C2-68 24V	C2-113 12V	C2-62-LED	C2-95-LED
Lamp Type	2G7	2D	LED	LED
Watts	1 x 13W (PL-13-WW)	1 x 6W (2D-16-CW)	6W	8W
Size (mm)	254 x 70 x 37.5	Ø250 x 47.5	186 x 179 x 37	200 x 120 x 40
Fitting Colour	Satin	Satin	White	White
Control	On: Always on, Door: Door open Light on, Off: Always off		Rocker switch, On/Off	

Commercial

LIGHTING

Ideal for steps,
interior or
exterior courtesy
lighting and
storage areas



Code	C2-98*	C2-104*
Volts	12-24VDC	12-24VDC
Size (mm)	90L x 24.7W x 14.3H	176L x 24.7W x 14.3H



Accessories
*Add **BK** (Black) or **CH** (Chrome) bezel for **C2-98**. Surface mounting. LED Lamp not included.

*Add colour to code: ● **R** (Red), ● **BL** (Blue), ● **GN** (Green), ● **Y** (Yellow), ● **CW** (Cool White)

2-year warranty on all LED products & 1-year warranty on battery-operated products, unless specified. LED warranty void without surge protection. Refer to page 128

NEW

NON-WEATHERPROOF LED STRIP LIGHTS IP20

2 Year Warranty



LD60W-R3528

5 Year Warranty



5Y-LD60W-R2835

2835 Chipset

Standard Range **12VDC** | 5m | Cutting length every 3rd LED | c/w Self-Adhesive Backing | Max Length Connected in series 5m

Code	No. of LEDs	Max Power	Lumens	*Add Colour to Code
IMG-R30*-S	30/0.5m	1.5W/m	135lm	
LD30W-R3528-*	30/m	2.4W/m	216lm	●R / ●GN / ●BL / ●Y / ○WW / ○DL
LD60W-R3528-*	60/m	4.8W/m	432lm	
LD120W-R3528-*	120/m	9.6W/m	864lm	
LD240W-R3528-*	240/m	19.2W/m	1728lm	

Professional Range **24VDC** | 10m | RA 80 | Cutting length every 6 LEDs | c/w Self-Adhesive Backing | Max Length connected in series 10m

5Y-LD30W-R2835-*	30/m	3.6W/m	324lm	●R / ●GN / ●BL / ●Y / ○WW / ○CW
5Y-LD60W-R2835-*	60/m	7.2W/m	648lm	
5Y-LD120W-R2835-*	120/m	12W/m	1080lm	

5050 Chipset

Standard Range **12VDC** | 5m | Cutting length every 3rd LED | c/w Self-Adhesive Backing | Max Length Connected in series 5m

Code	No. of LEDs	Max Power	Lumens	*Add Colour to Code
LD30W-R5050-*	30/m	7.2W/m	576lm	●R / ●GN / ●BL / ●Y / ○WW / ○DL / ●●● RGBW
LD60W-R5050-*	60/m	14.4W/m	1152lm	
LD120W-R5050-*	120/m	28.8W/m	2304lm	

RGBW Range **24VDC** | 5m | Cutting length every 6th LED | c/w Self-Adhesive Backing | Max Length Connected in series 5m

LD30W-R5050-RGBW	30/m	7.2W/m	576lm	●●●● RGBW
LD60W-R5050-RGBW	60/m	14.4W/m	1152lm	
LD120W-R5050-RGBW	120/m	28.8W/m	2304lm	

Professional Range **24VDC** | 10m | RA 80 | Cutting length every 6 LEDs | c/w Self-Adhesive Backing | Max Length connected in series 10m

5Y-LD30W-R5050-*	30/m	5W/m	400lm	●R / ●GN / ●BL / ●Y / ○WW / ○CW / ●●● RGB
5Y-LD60W-R5050-*	60/m	10W/m	800lm	

2 Year Warranty



LD60W-R5050

5 Year Warranty



5Y-LD30W-R5050

NEW



COB Strip

24VDC | 5m | Cutting length 65mm | c/w Self-Adhesive Backing | Max length connected in series 10m | 180° Beam Angle | CRI 90 | Even light distribution | No hot spots | Ideal for Architectural, Archway Bridge, Auditorium, Signage & Channel lettering

Code	No. of LEDs	Max Power	Lumens	*Add Colour to Code
LD-COB-R-*	336/m	10W/m	900lm	●R / ●GN / ●BL / ●Y / ○WW / ○DL
LD-COB-R-RGB	840/m	10W/m	900lm	●●● RGB

Accessories

Code 2 Wire	Code 4 Wire	Description
LD-COB-R-2PC	LD-COB-R-4PC	Power connector
LD-COB-R-2MC	LD-COB-R-4MC	Middle connector
LD-COB-R-2JC	LD-COB-R-4JC	Jumper connector
LD-COB-R-2L	LD-COB-R-4L	'L' connector
LD-COB-R-2T	LD-COB-R-4T	'T' connector
LD-COB-R-2X	LD-COB-R-4X	'X' connector

Power Connector

Middle Connector

Jumper Connector



'L' Connector



'T' Connector



'X' Connector

NEW



WS2811 Addressable LED Strip

12VDC | 5m | Cutting length every 3rd LED | c/w Self-Adhesive Backing | Max length in series 5m | WS2811 is an addressible LED strip controlled by external IC WS2811 | Each IC controls 3 leds. Each pixel is individually addressible

Code	No. LEDs	Max Power	Lumen	Colour
LD-WS2811-RGB	60	14.4W/m	1000-1440lm	RGB

WEATHERPROOF LED STRIP LIGHTS IP54

2 Year Warranty



5 Year Warranty



2835 Chipset

Standard Range 12VDC | 5m | Cutting length every 3rd LED | c/w Self-Adhesive Backing | Max Length Connected in series 5m

Code	No. of LEDs	Max Power	Lumens	*Add Colour to Code
IMG-OR30*-SF	30/0.5m	1.5W/m	135lm	● R / ● GN / ● BL / ● Y / ○ WW / ○ DL
IMG-WR30*-SF	30/0.5m	1.5W/m	135lm	
LD30W-W3528-*	30/m	2.4W/m	135lm	
LD60W-W3528-*	60/m	4.8W/m	432lm	
LD120W-W3528-*	120/m	9.6W/m	864lm	

Professional Range 24VDC | 10m | RA 80 | Cutting length every 6 LEDs | c/w Self-Adhesive Backing | Max Length connected in series 10m

5Y-LD30W-W2835-*	30/m	3.6W/m	396lm	● R / ● GN / ● BL / ● Y / ○ WW / ○ CW
5Y-LD60W-W2835-*	60/m	7.2W/m	792lm	

5050 Chipset

Standard Range 12VDC | 5m | Cutting length every 3rd LED | c/w Self-Adhesive Backing | Max Length Connected in series 5m

Code	No. of LEDs	Max Power	Lumens	*Add Colour to Code
IMG-OR15*-3SF	30/0.5m	3W/m	120lm	● R / ● GN / ● BL / ● Y / ○ WW / ○ DL / ● ● ● RGB / ● ● ● ○ RGBW
IMG-WR15*-3SF	30/0.5m	3W/m	120lm	
LD30W-W5050-*	30/m	7.2W/m	192lm	
LD60W-W5050-*	60/m	14.4W/m	384lm	
LD120W-W5050-*	120/m	28.8W/m	2304lm	

Professional Range 24VDC | 10m | RA 80 | Cutting length every 6 LEDs | c/w Self-Adhesive Backing | Max Length connected in series 10m

5Y-LD30W-W5050-*	30/m	5W/m	400lm	● R / ● GN / ● BL / ● Y / ○ WW / ○ CW / ● ● ● RGB
5Y-LD60W-W5050-*	60/m	10W/m	800lm	

2 Year Warranty



5 Year Warranty



NEW

COB LED STRIP LIGHTS IP65

24VDC | 5m | Cutting length 65mm | c/w Self-Adhesive Backing | Max length connected in series 10m | 180° Beam Angle | CRI 90 | Even light distribution | No hot spots | Ideal for Architectural, Archway Bridge, Auditorium, Signage & Channel lettering

Code	No. of LEDs	Max Power	Lumens	*Add Colour to Code
LD-COB-W-*	336/m	10W/m	900lm	● R / ● GN / ● BL / ● Y / ○ WW / ○ DL / ● ● ● RGB
LD-COB-W-RGB	840/m	10W/m	900lm	

Accessories

Code 2 Wire	Code 4 Wire	Description
LD-COB-W-2PC	LD-COB-W-4PC	Power connector
LD-COB-W-2EC	LD-COB-W-4EC	End Cap



Power Connector



End Cap

COB LED STRIP LIGHTS - 230VAC IP67

High Voltage COB Strip Light - 230VAC | 280 LED high density FOB linear flexible LED rope | Cutting mark 500mm | 180° Beam Angle | UV Protected Housing

Code	No. of LEDs	Max Power	Lumens	*Add Colour to Code
RW-SL-01-*-*	320 LEDs/m	12W/m	840lm/m	CW / WW / DL / ● R / ● BL / ● GN / ● Y / ● ● ● RGB

* Add Length to Code: 5M (5 Meters), 50M (50 Meters)

For Accessories, see page 80 High Voltage Strip Accessories.

NEW



NEW

FLEXIBLE WALL WASHER STRIP LIGHTS IP67

24VDC | 5m | 30° beam angle | Designed to replace traditional wall washers | Small flexible and light weight and easy to install



Code	No LED's	Max Power/m	Lumens	*Add colour to code
FW48-W30D-*	48/m	18W	1915lm	WW / CW / DL
FW42-W30D-RGB	42/m	8W	540lm	●●● RGBW

Accessories

Code	Description
FW-AP	1m Aluminium channel
FW-AM	Angle bracket - Can adjust Angle
FW-MC	Metal clip for mounting
FW-SC	Silicone clip for mounting
VHB3M-18	3m Tape - Supplied in 1m Length

LED PLANT GROW STRIPS IP65



Supplied with 230VAC Power Adaptor | LED Strip is 24VDC | Lumens: 10-22lm | Viewing Angle: 120° | Blue (Wave Length: 455-465nm) - Good for Photosynthesis | Red (Wave Length: 660-665nm) - Peak Wavelength for Photosynthesis & Photoperiodism - Good for Blooming & Fruits | Red/Blue in one Chip: Red:Blue = 5:1 (Suitable for most Plant Growing)

Code	Description	No. LEDs	Max Power/m	Length
HH-SRB60W	Red/Blue 5:1	60/m	14W/m	10m
HH-SRB120W	Red/Blue 5:1	120/m	28W/m	10m
HH-SR-60W	Red	60/m	14W/m	10m
HH-SB-60W	Blue	60/m	14W/m	10m

NEW

ANTI-GLARE LED STRIPS IP65



Input Voltage: 24VDC - 5m Roll | 120° Viewing Angle | Even Light Distribution | Ideal for Architectural, Archway, Bridge, Auditorium, Signage & Channel Letter Lighting | Dimensions: 12 x 4.5mm | Supplied with front and back Power Connectors

Code	No. LEDs	Max Power	Lumens	*Add Colour to Code
AG210-W2835-*	210/m	12W/m	1300lm	WW / CW / DL

Accessories

Code	Description
AG210-CON	Male and Female Connector
AG210-CL/10	Mounting Clips Pack of 10

WEATHERPROOF LED STRIP LIGHTS IP68



2835 Chipset - 12VDC | 5m | Silicone gel insulated tube | Min cutting length every 3rd LED | Max length connected in series 5m

Code	No. of LEDs	Max Power	Lumens	*Add Colour to Code
WP30W-W3528-*	30/m	2.4W/m	216lm	●R / ●GN / ●BL /
WP60W-W3528-*	60/m	4.8W/m	432lm	●Y / ●WW / ●DL

5050 Chipset - 12VDC | 5m | Silicone gel insulated tube | Min cutting length every 3rd LED | Max length connected in series 5m

Code	No. of LEDs	Max Power	Lumens	*Add Colour to Code
WP30W-W5050-*	30/m	7.2W/m	576lm	●R / ●GN / ●BL /
WP60W-W5050-*	60/m	14.4W/m	1152lm	●Y / ●WW / ●DL
WP120W-W5050-*	120/m	28.8W/m	2304lm	/ ●●● RGB

Accessories

Code	Description	Pack Size
SP108F	Plastic Mounting Clip	100
SP109F	End cap with no holes	10
SP110F	End cap with 2 holes	10
SP112F	90g Silicone Gel	10

230VAC LED STRIP LIGHTS



Blister Pack



Reel

High Voltage Strip Light IP67 - Does not require power supply | Can run up to 50 meters without voltdrop | Cutting mark every 1m | 180° Beam Angle | UV Protected Housing

Code	No. of LEDs	Max. Power	Lumens	*Add Colour to Code
Supplied in Blister Pack				
HV60W-W3528-*.*	60/m	4.8W/m	336lm/m	WW / DL / ● R
HV30W-W5050-*.*	30/m	7.2W/m	432lm/m	/ ● BL / ● GN
HV60W-W5050-*.*	60/m	14.4W/m	864lm/m	/ ● Y

* Add Length to Code: **1M** (1 Meters), **5M** (5 Meters)

Code	No. of LEDs	Max. Power	Lumens	*Add Colour to Code
Supplied on Reel				
HV60W-W3528-*.*	60/m	4.8W/m	336lm/m	WW / DL / ● R /
HV30W-W5050-*.*	30/m	7.2W/m	432lm/m	● BL / ● GN /
HV60W-W5050-*.*	60/m	14.4W/m	864lm/m	● Y / ● ● RGB

* Add Length to Code: **10M** (10 Meters), **50M** (50 Meters)



HVC-10M-DL

HVR-*.DL

High Voltage Strip on Extention Reel IP65 - 230VAC | c/w power connector | Ideal for work, functional and decorative lighting

Code	No. of LEDs	Max. Power	Lumens	*Add Colour to Code
HVC-10M-DL	120/m	9W/m	810lm/m	6500K
HVR-*.DL	180/m	12W/m	1100lm/m	6500K

* Add Length to Code: **15M** (15 Meters), **25M** (25 Meters), **50M** (50 Meters)

Accessories

Code	Description
HVR-PC	1.5m SA plug IP44- Rubber Cable
HVR-TC	T Connector

Accessories

Code (Blister Pack)	Code (Reel)	Code (COB)	Description
HV-WIRE-3528	HV-WIRE-3528	-	3528 Power Cord 100m Max
HV-WIRE-5050	HV-WIRE-5050	-	5050 Power Cord 50m Max
-	-	HV-COB-PC	Power Connector
-	HV-WIRE-RGB	HV-COB-RGB	Power Cord for RGB Strip c/w Basic Controller
-	HV-RGB-RC	HV-COB-M-RGB	Multifunction RGB Controller and Remote
HV-CON-3528/5	HV-CON-3528/5	-	3528 Middle Connector Pack of 5
HV-CON-5050/5	HV-CON-5050/5	-	5050 Middle Connector Pack of 5
-	-	HV-COB-MC	Middle Connector pack of 5
-	HV-CON-RGB/5	HV-COB-CON-RGB	RGB Middle Connector pack of 5
HV-EC-3528/10	HV-EC-3528/10	-	3528 End Cap Pack of 10
HV-EC-5050/10	HV-EC-5050/10	-	5050 End Cap Pack of 10
-	-	HV-COB-EC/10	End Cap Pack of 10
HV-CLIP-3528/10	HV-CLIP-3528/10	-	3528 Mounting Clip Pack of 10
HV-CLIP-5050/10	HV-CLIP-5050/10	-	5050 Mounting Clip Pack of 10
-	-	HV-COB-CLIP/10	COB Mounting Clip Pack of 10

Commercial

LIGHTING



HV-WIRE-3528
HV-WIRE-5050

HV-WIRE-RGB



HV-RGB-RC



HV-CON-3528/5
HV-CON-5050/5



HV-CON-RGB/5



HV-EC-3528/10
HV-EC-5050/10



HV-CLIP-3528/10
HV-CLIP-5050/10

LED NEON FLEX

Neon LED is the state of the art LED lighting product that simulates the effect and look of neon. Also, Neon LED Strip brings back the Neon Lighting without the hassles and dangers associated with neon light. No high voltage transformers, dangerous neon gases and fragile custom glass tubes to deal with!

LED Neon Soft Jacket Flex IP65 - LED Neon Flex are soft and easily bent | Ideal for indoor & outdoor signage applications

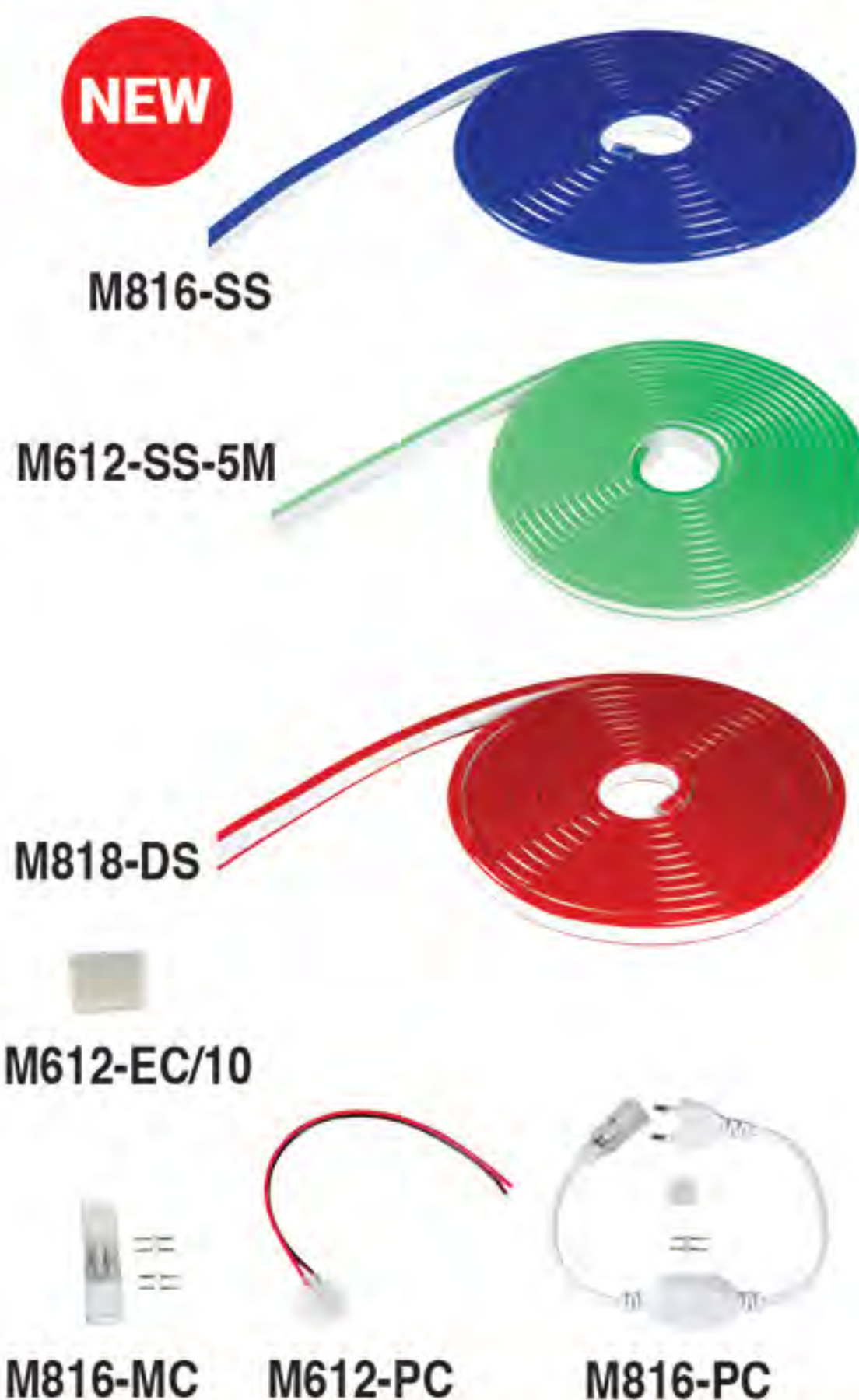

Code	Voltage	Cutting Length	No. of LEDs P/m	Max. Power	Neon Projection	Dimensions (mm)	*Add Colour to Code
M612-SS-5M*	12V	25mm	120	6W/m	Single Sided	6(W) x 12(H)	WW / CW / ● R /
M816-SS-*.*	230V	1m	120	8W/m	Single Sided	8(W) x 16(H)	● BL / ● GN /
M818-DS-*.*	230V	1m	120	8W/m	Double Sided	8(W) x 18(H)	● Y / ● P / ● PR
M1020-SS-RGBW	12V	50mm	120	10W/m	Single Sided	10(W) x 20(H)	● ● ● ○ RGBW

* Add Length to Code: 5M (5 Meters), 50M (50 Meters)

Accessories

Code M612	Code M816	Code M818	Code M1020	Description
M612-PC	M816-PC	M818-PC	M1020-PC	Power Connector
-	M816-MC-D	M818-MC-D	M1020-MC-D	Middle Connector
M612-MC	M816-MC	M818-MC	M1020-MC	Middle Jumper Connector
M612-EC/10	M816-EC/10	M818-EC/10	M1020-EC/10	End Cap
M612-30PVC	M816-30PVC	-	M1020-30PVC	300mm PVC Channel
M612-1ALU	M816-1ALU	-	M1020-1ALU	1m Aluminium Channel
M612-2ALU	-	-	-	2m Aluminium Channel
-	-	M818-CL/10	-	Plastic Mounting Clips

Frosted Jacket Neon Flex IP65 - 5m Length | c/w Power Cord

Code	Voltage	Cutting Length	No. of LEDs P/m	Max. Power	Neon Projection	Dimensions (mm)	*Add Colour to Code
LR2131-S-*	230V	25mm	120	6W	Single Sided	8(W) x 16(H)	WW / CW / DL / ● R / ● BL / ● GN / ● Y

DIY Shaping LED Neon Strip IP67 - Blister Pack | 5m Roll | The LED Neon Flex is designed to shape into any form without the need of clips or profile to hold the shape | c/w power connector, & mounting brackets & screws.

Code	Voltage	Cutting Length	No. of LEDs P/m	Max. Power	Neon Projection	Dimensions (mm)	*Add Colour to Code
LR1131-DIY-5M-*	12VDC	25mm	120	24W/m	Single Sided	6 x 12	WW / CW / DL / ● R / ● BL / ● GN / ● Y

DECORATIVE LED NEON LIGHTS IP65



Flexible LED Tube

24VDC | 5m | Flexible | No Specific cutting length | 360° Illumination | Tube diameter 23mm

Code	No. of LEDs	Max Power	Lumens	*Add Colour to Code
DL-ECN25-*	168 x 2/m	14.4w/m	1400lm	WW / CW / DL / ● R / ● GN / ● BL / ● Y















Accessories

Code	Description
DL-ECN25-FP	Straight Power out Cap and End Cap
DL-ECN25-SO	Side Power out Cap and End Cap
DL-ECN25-MC/5	Arched shaped PC Mounting clip/5(Pack)
DL-ECN25-PCG	1m Arched Shaped PC Profile
DL-ECN25-VC	1m vertical PC Ceiling mount Tube c/w metal head cap, metal end cap, 1m Hanging wire

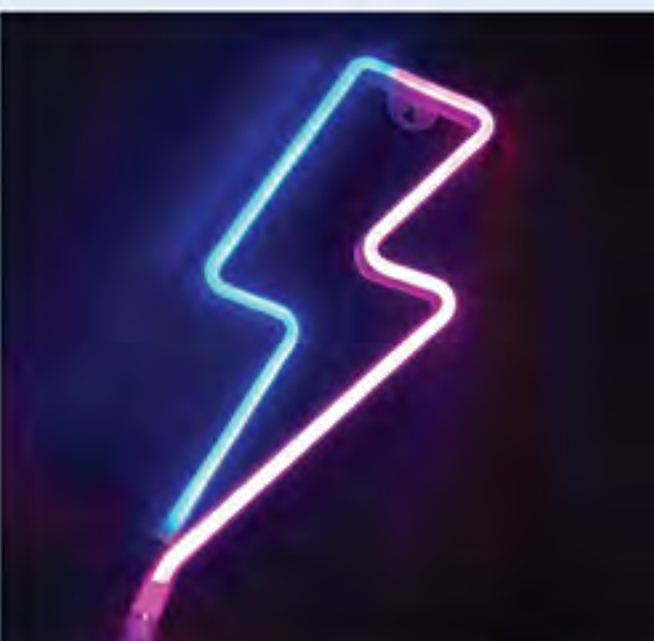
NEW

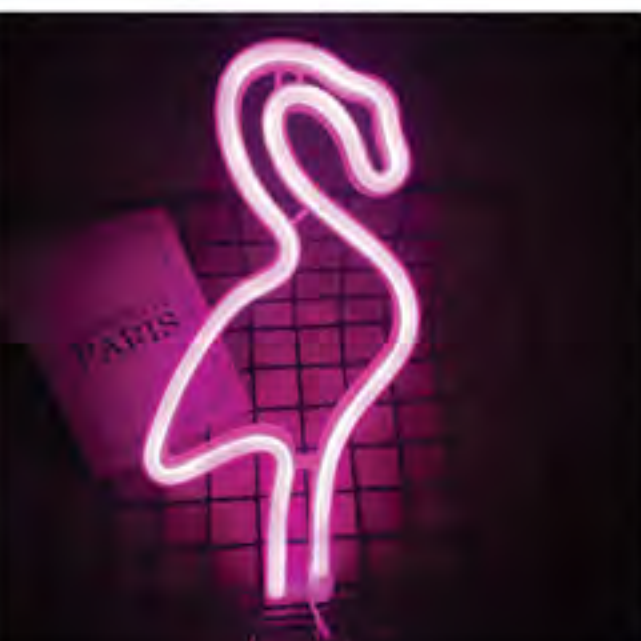
NEON LED WALL LIGHT KITS

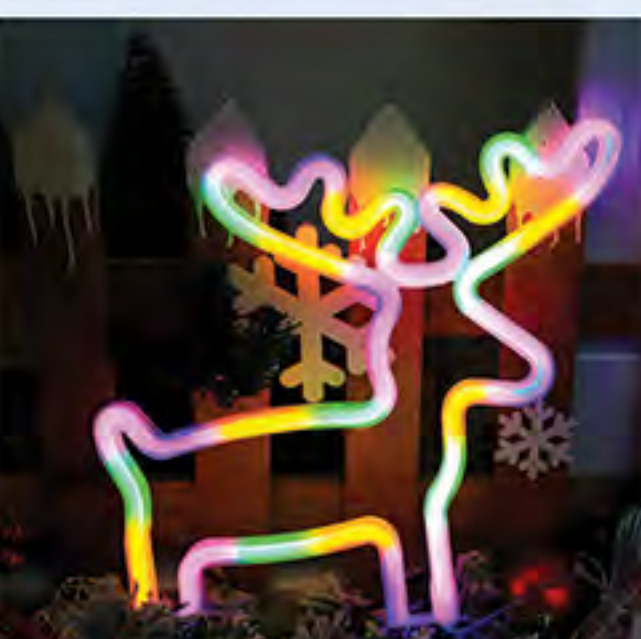
Decorative Neon Wall Art | 3X AAA | batteries (not incl.) | USB

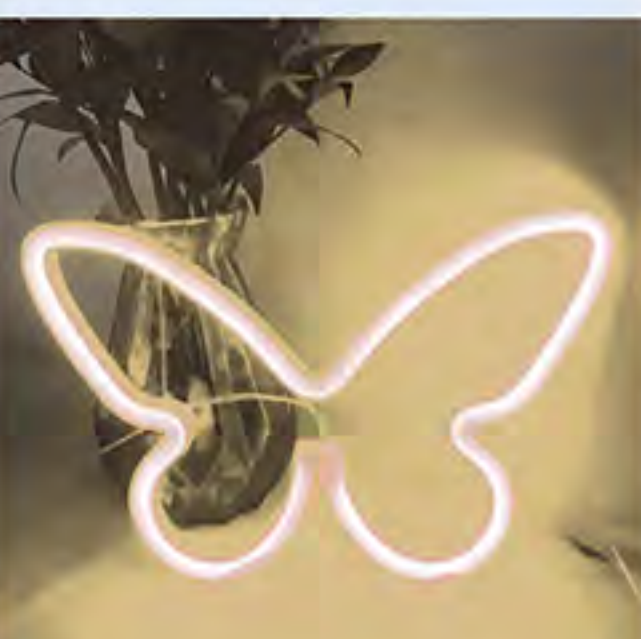
				
Code	HH-NWL01	HH-NWL02	HH-NWL03	HH-NWL06
Description	Bulb	Lip	Love	Hello
Colour	RGB	Red	RGB	White + Pink
Size (mm)	260 x 165 x 20	280 x 250 x 20	350 x 130 x 20	300 x 210 x 20
				
Code	HH-NWL07	HH-NWL08	HH-NWL11	HH-NWL12
Description	Yeah	Love Heart	Heart	Shooting Star
Colour	Red	White + Pink	Red	White + Blue
Size (mm)	350 x 180 x 20	270 x 255 x 20	315 x 275 x 20	300 x 180 x 20
				
Code	HH-NWL13B	HH-NWL15	HH-NWL19	HH-NWL25
Description	Lightning	Star	Rainbow	Flamingo
Colour	Pink + Blue	Warm White	Red + Orange + Yellow + Green + Blue	Pink
Size (mm)	340 x 130 x 20	280 x 280 x 20	300 x 170 x 20	290 x 140 x 20
				
Code	HH-NWL26	HH-NWL27	HH-NWL28	HH-NWL29E
Description	Unicorn	Reindeer	Cat	Butterfly
Colour	Warm White	RGB	Blue	Warm White
Size (mm)	250 x 160 x 20	270 x 240 x 20	230 x 180 x 20	325 x 160 x 20













Commercial

LIGHTING

NEW

NEON LED WALL LIGHT KITS

Decorative Neon Wall Art | 3X AAA | batteries (not incl.) | USB

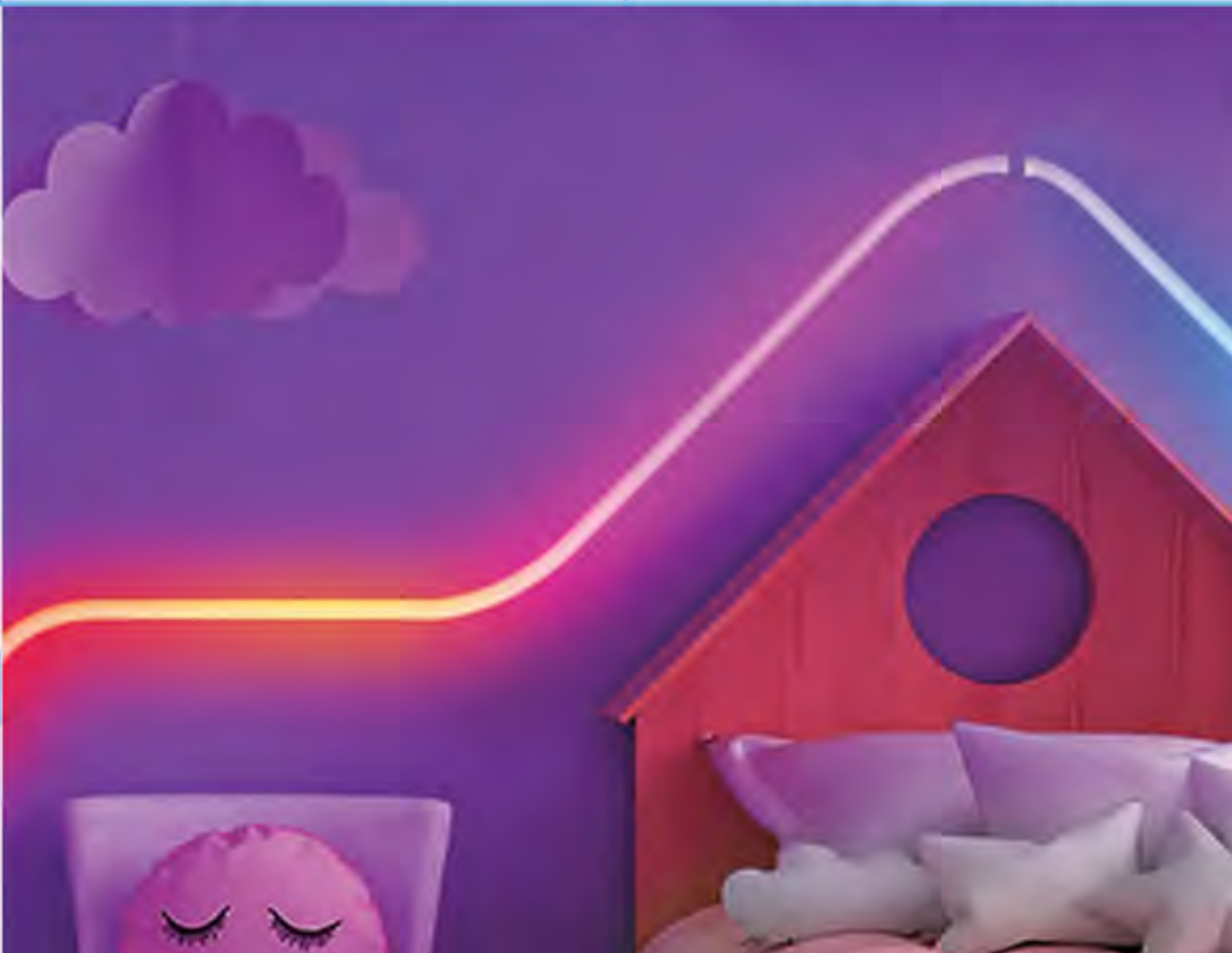
				
Code	HH-NWL31	HH-NWL32	HH-NWL33	
Description	Dolphin	Whale	Dinosaur	
Colour	Blue	Blue	Green	
Size (mm)	190 x 155 x 20	190 x 160 x 20	190 x 180 x 28	
				
Code	HH-NWL35	HH-NWL36	HH-NWL38E	HH-NWL40
Description	Snoopy	Mickey	High-Heeled Shoes	Cactus
Colour	Cool White	Red	Blue	Green+Orange
Size (mm)	240 x 170 x 20	240 x 170 x 20	200 x 240 x 20	340 x 180 x 20
				
Code	HH-NWL41	HH-NWL42	HH-NWL43	HH-NWL44
Description	Christmas Tree	Bell	Snow	Christmas Stocking
Colour	Green	Warm White	Cool White	Red + White
Size (mm)	240 x 180 x 20	300 x 230 x 20	250 x 250 x 20	250 x 190 x 20
				
Code	HH-NWL51	HH-NWL52		
Description	Open	Closed		
Colour	Multi-Colour	Multi-Colour		
Size (mm)	290 x 140 x 20	410 x 160 x 20		

Commercial

LIGHTING

DIGITAL & MUSIC STRIP LIGHTS



Music Activated LED Strip RGB Kit IP65 - c/w Music Controller, RGB Controller and 230VAC Power Supply

Code	No. LEDs / m	Max Power / m	Length
MUS30-5050-RGB	30	5W / m	5m



LED FLEX STRIP KITS - 5M LENGTHS



IP20



c/w power supply & ON/OFF switch



IP65



c/w dimmer & CW/WW control



IP65



c/w RGB remote controller

NEW



IP20



c/w RGB remote controller

NEW

Code	LS1761P-*	LS1778-CW/WW	LS1702P-RGB	LS1702P-RGBW	NW1702P-RGBW
Size (mm)	5000L x 8W x 4H	5000L x 14W x 4H	5000L x 14W x 4H	5000L x 14W x 4H	5000L x 14W x 4H
Lumen	900 - 1050lm	1400lm	N/A	N/A	N/A
LEDs	60/m (total 300Pcs 24W) 3528	60/m (total 300Pcs 48W) 3528	30/m (total 150Pcs 36W) 5050	30/m (total 150Pcs 36W) 5050	30/m (total 150Pcs 36W) 5050
Colour	*Add colour to code: ○ CW (5000k), ○ WW (3200k), ● R (Red), ● GN (Green), ● BL (Blue), ● Y (Yellow)	○ CW (Cool White), ○ WW (Warm White)	●●● RGB (Red, Green, Blue)	●●●○ RGBW (Red, Green, Blue, White)	●●●○ RGBW (Red, Green, Blue, White)

HEXAGON LED TILES

Tiles - Wifi enabled | Touch Control | Music Sync | Screen Mirror | 100lms per panel | CRI >80 | RGBW 1200K-6500K, + 16 million colours | Dimmable | Mounting Type : double sided Tape or Mounting Screws | Compatible with Apple, Amazon, Google, IFTTT, Smarthings | Create any patterns by interlinking

Code	Max Power Supply Power	Max Energy Consumption per Panel	Max Power per Power Supply	Max Panels per controller	Dimension
NL42-0001HX-P	42W	2W	21 hexagons per 42W PSU	500 Hexagons	Ø230x10mm

Accessories

Code	Description
NL42-0002HX-C	Smart Controller
NL26-0001	Remote Control
NC04-0051	230VAC 42W Power Supply
NC04-0070	Linking Cables (3 per pack)
NC04-0042	Rigid Links (10 per pack)



NL42-0001MX-P



L26-0001



NL42-0002HX-C



NC04-0051



NC04-0070



NC04-0042

LED UNDER BED STRIP WITH MOTION SENSOR



FST-CDB

Rechargeable - USB Port for Charging | Working Time 3hrs | Motion Sensor Distance: 2-5m | Time Adjustable 15sec - 6min

Code	Wattage	Lumens	LED p/m	Length
FST-CDB-1M-*	2.4W	240lm	30	1m

* Add colour to code: ○ **WW** (Warm White) 2700K , ○ **CW** (Cool White) 4200K, ○ **DL** (Daylight) 6000K

Direct 230V - Dimmable | Motion Sensor Distance: 2-5m | Time Adjustable 30s - 380s | Colour Temperature: Warm White 2700K

Code	Wattage	Lumens	LED p/m	Length
BL60-W3528-WW	2.8W	260lm	45	1.5m
BL60-W3528-WW/2	2.8W	260lm	45	2 x 1.5m

BL60-W3528-WW/2

BL60-W3528 -WW

USB MULTI COLOUR MOOD LIGHT FOR TV IP20

USB Power 5VDC | Easy Assembly | Remote Control | Two Available Options, 2 LED Strips or 4 LED Strips per Controller



Code	Wattage	Lumens	LED/m	Length (mm)
TV30-R5050-RGBW/2	4.8W/m	300lm	32	2 x 500 (2 x Strips)
TV30-R5050-RGBW/4	9.6W/m	600lm	32	4 x 500 (4 x Strips)

LED TAIL LIGHT STRIP IP67

Input Voltage: 12VDC | 4 Pin tow adaptor connection | Flexible design | Adventure Proof | LED Signals: Driving mode - Glows bright red, Left Turn - Flash on the left, Right Turn - Flash on the right, Break - Beam dark red across, Reverse - Beam White across.



Code	Wattage	LED p/m	Size (mm)
TG60-2835-R/W	1.2W	60	13 x 6 1244

UNDER DASH LIGHTING KIT

Input Voltage: 12-24VDCVDC | c/w Cigarette Lighter Adaptor | 4 x Waterproof LED Strips - RGB | Wireless IR Remote & Controller | Dimmable | Colour Scenes



Code	Description	Wattage	LEDs	Size (mm)
UD-5050-RGB	Colour Changing c/w controller	18W	18 x 4	300 x 10
UD-5050-RGBM	Colour Changes to the Beat of the Music c/w controller	12W	12 x 4	210 x 10

GAZEBO LIGHT KIT

Input Voltage: 5VDC | 160° Beam Angle | Colour Temperature: 5000K | c/w Mounting Clips | 4 x 3 Meter light strips | On/Off Switch | Easy to Assemble



**Ideal for
Camping**

Code	Description	Wattage	Lumens	Size (mm)
SG-TLKA1	Gazebo 5VDC LED Kit	4 x 3W	1500lm	4000 x 3000

CAMPING LED STRIP LIGHT IP68



Input Voltage: 5V / 12VDC | One Side with USB, other side with waterproof DC female connector with cigarette & battery clip | Two mounting methods, hook & velcro | Dimmable | 4 Different colour methods; Warm White, Cool White, R+G+B (SOS) & Amber to keep insects away.

Code	Wattage	Lumens	LED/m	Length (mm)
KU-CAMPSTRIP-12VDC	10W	500lm	60 + 30	1000mm

LED STRIP CONNECTION SYSTEM

	LED Strip	Right Bend	Left Bend	Tee	Cross
Code	SL101- [*] - [*] SL102- [*] -RGB	SL-CL11- [*] SL-CL21-RGB	SL-CL12- [*] SL-CL22-RGB	SL-CT1- [*] SL-CT2-RGB	SL-CC1- [*] SL-CC2-RGB
No. of LEDs	9/18	2	2	3	3
Power	1.4W/2.8W	0.5W	0.5W	0.5W	0.5W
Size (mm)	250/500 x 9.8	45 x 21	45 x 21	56 x 45	56 x 56

* Add size to code: 250mm or 500mm. * Add colour to code: ● R (Red), ● Y (Yellow), ● GN (Green), ● BL (Blue), ○ PW (Pure White)

Application

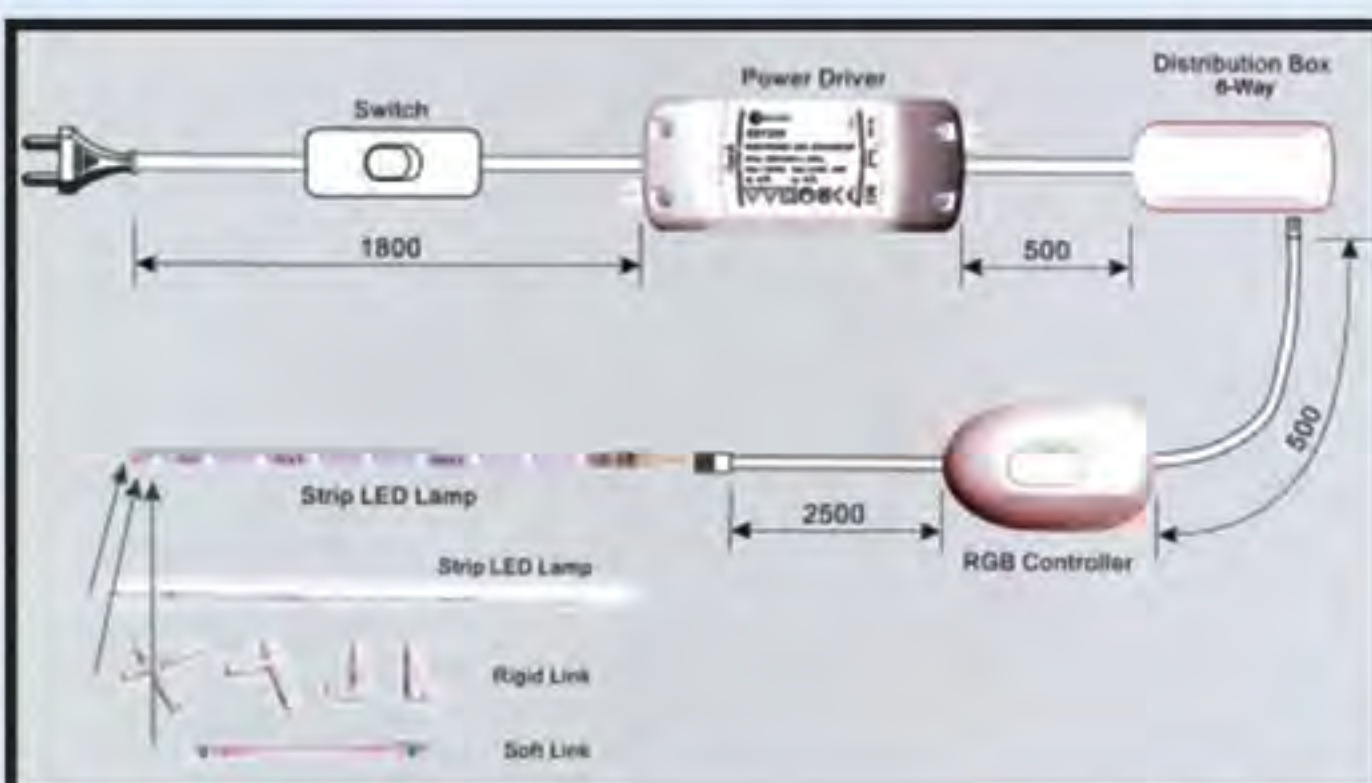

Code	Description
ED1230	Power driver 12V 25W max
SL-C10	RGB controller (10 functions)
SL-DB6-C	6-Way distribution box for use with single colour LED strips
SL-DB6-RGB	6-Way distribution box for use with RGB LED strips
SL-DB12	12-Way distribution box for use with LED spot lights
SL-SC	Soft link for connecting LED strips to each other (80mm long)
SL-IC	Initial connector for connecting LED strips to power driver (2500mm long)



NEW

FLEXIBLE SILICONE PROFILE

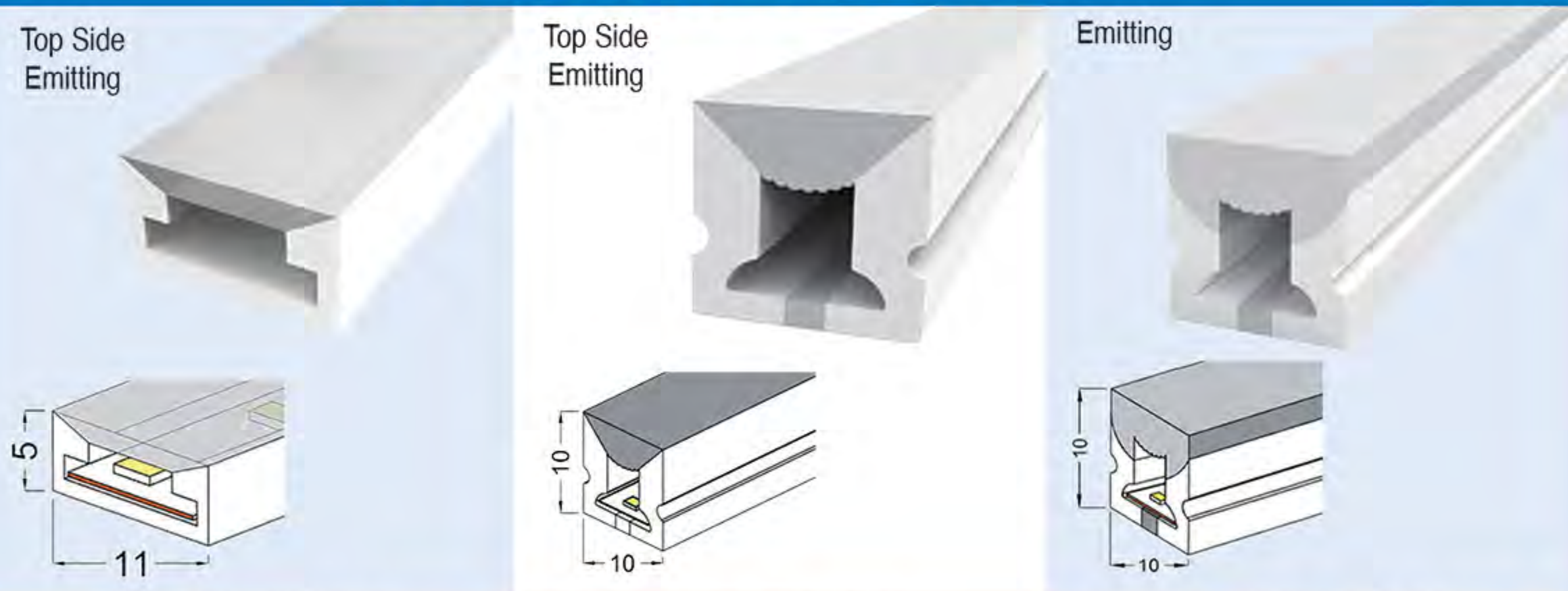

Code	SIL-5X11-FRONT/*	SIL-10X10-FRONT/*	SIL-10X10-3SIDES/*
*Add Length to Code	3m / 5m	3m / 5m	3m / 5m
LED Strip Dimensions	8mm	5mm	5mm
Power Sleeve	SL-0511-SPS	SL-1010A-SPS	SL-1010B-SPS
End Cap	SIL-5X11-CLIP/10	SL-1010A-EC	SIL-10X10-CAP
Mounting Clips	SIL-5X11-CAP/5	-	SIL-10X10-CLIP
30mm Alu. Profile	-	SL-1010A-AP	SIL-10X10-FLEX-PROFILE/M

LED PROFILES

Aluminium "U" profile and accessories
Does not c/w LED Strip
 LED Strip to be Ordered Separately



Code	UPRO-3.1M	UPRO-CWC	UPRO-CWF	UPRO-CFC	UPRO-CFF	UPRO-EC
Description	"U" profile	Cover with wings - clear	Cover with wings - frosted	Flush cover - clear	Flush cover - frosted	Endcap for Profile with strain relief
Supplied as	3.1m Length	3.1m Length	3.1m Length	3.1m Length	2.5m Length	-
Material	Aluminium	PMMA	PMMA	PMMA	PMMA	-

Profile and covers to be ordered separately.

Monza and Nizza Profiles below and also **MZA** profiles above can be mounted using the "U" Profile

Does not c/w LED Strip
 LED Strip to be Ordered Separately



Code	MZAPRO-2M	NIZPRO-3.1M	LINEPRO-2M	MONPRO-3.1M	CANPRO-2M
Description	Monza Profile - For 8mm strips	Nizza Profile - For 8mm strips	Half Round Profile - For 8mm strips	Monaco Profile - For 4mm strips	Cannes Profile - For 8mm strips
Size H x W x L (mm)	14 x 11 x 2000	12 x 11 x 3100	20 x 12 x 2000	5 x 7 x 3100	10 x 10 x 2500
Mounting Clips	MZAPRO-CL	NIZPRO-CL	-	MONPRO-CL	CANPRO-CL
End Caps	MZAPRO-EC	NIZPRO-EC	-	MONPRO-EC	CANPRO-EC
Material	PMMA	PMMA	PMMA	PMMA	PMMA

LED PROFILES

LED Recessed Aluminium Profile

Supplied without LED Strip - to be Ordered Separately

End Caps and Mounting clips to be ordered separately



Code	PFFLL01	PFRLS05	HL-BAPL017	HL-BAPL023
Length	2m	2.5m	2m	2m
Mounting Clips	-	-	HL-BAPL017-CL	-
Spring Clips	-	-	HL-BAPL017-SC	-
End Caps	PFFLL01-EC	PFRLS05-EC	HL-BAPL017-EC	HL-BAPL023-EC

LED Surface Aluminium Profile

Supplied without LED Strip - to be Ordered Separately

End Caps and Mounting clips to be ordered separately

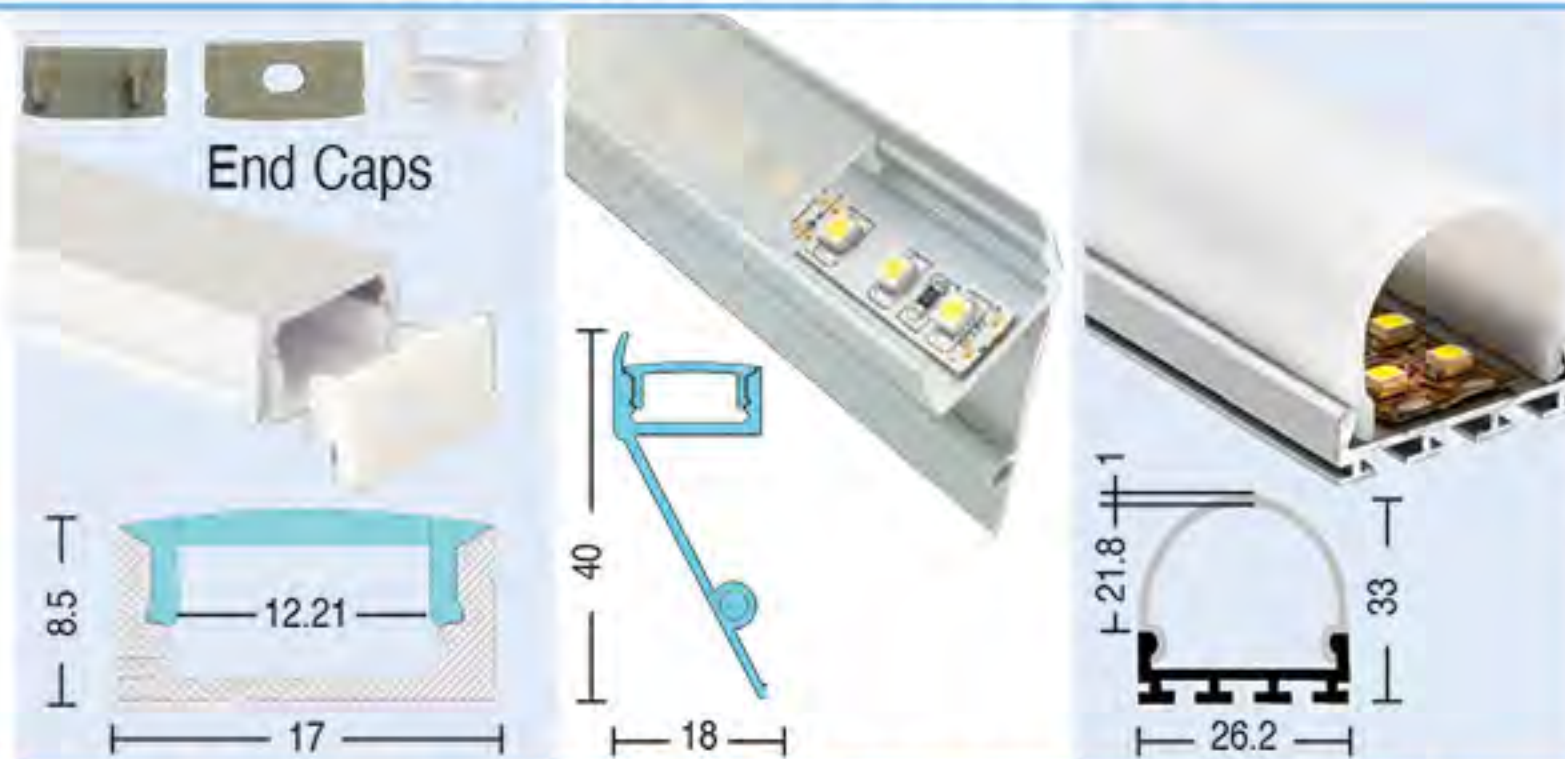

Code	PFRLS06	HL-BAPL030	LUXX-3R
Length	2.5m	2m	2m
Mounting Clips	PFRLS06-CL	HL-BAPL030-CL	LUXX-3R-CL
End Caps	PFRLS06-EC	HL-BAPL030-EC	LUXX-3R-EC

LED Stairs Aluminium Profile

Size: 80 x 42mm l c/w Treads



Code	HL-BAPL022	HL-BAPL047	PFSTR01
Length	2.5m	2.5m	2m
Mounting Clips	-	-	PFSTR01-CL
End Caps	HL-BAPL022-EC	HL-BAPL047-EC	PFSTR01-EC

LED 90° Aluminium Profile

Supplied without LED Strip - to be Ordered Separately

End Caps and Mounting clips to be ordered separately



Code	HL-BAPL015	PFSC01	HL-BAPL016	PFSC02
Length	2.5m	2m	2.5m	2.5m
Mounting Clips	HL-BAPL015/6-CL	PFSC01-CL	HL-BAPL015/6-CL	PFSC02-CL
End Caps	HL-BAPL015-EC	PFSC01-EC	HL-BAPL016-EC	PFSC02-EC

LED Glass Aluminium Profile

Supplied without LED Strip - to be Ordered Separately

End Caps and Mounting clips to be ordered separately



Code	HL-BAPL044C
Length	2m
Mounting Clips	-
End Caps	HL-BAPL044C-EC

Wardrobe Aluminium Profile



Code	HS-LEDAP37
Length	3m
Mounting Clips	HS-LEDAP37-MC01 / HS-LEDAP37-MC02
End Caps	HS-LEDAP37-EC

PROFILES

Plaster Construction Aluminium Profile

Code	HS-LEDAP3303	HS-LEDAP3302	HS-LEDAP3301
Length	3m	3m	3m
End Caps	HS-LEDAP3303-EC	HS-LEDAP3302-EC	HS-LEDAP3301-EC
Code	HS-LEDAP3304	HS-LEDAP1201	HS-LEDAP3305
Length	3m	3m	3m
End Caps	HS-LEDAP3304-EC	HS-LEDAP1201-EC	HS-LEDAP1202-EC

Supplied without LED Strip - to be Ordered Separately | End Caps to be Ordered Separately

LED PROFILES C/W LEDS

Single Colour or Colour Changing

Supply voltage: 12VDC
Supplied c/w required mounting accessories
Maximum length connected in series: 2000mmØ

Code	VIS5*-A*	MZA*-A*	IMO2*-A*
Size H x W (mm)	15 x 18	14 x 11	20 x 12
*Specify Length (mm)	255 (2.5W) 505 (4.5W) 1005 (9.0W)	272 (2.5W) 522 (4.5W) 1022 (9.0W)	260 (2.5W) 510 (4.5W) 1010 (9.0W)
Connection	Wire	Wire	Wire
Material	Aluminium	PMMA	PMMA

Single Colour or Colour Changing

Supply voltage: 12VDC
Supplied c/w required mounting accessories
Maximum length connected in series: 2000mmØ

Code	VIS6*-A*	MON2*-A*	CAN*-A*
Size H x W (mm)	15 x 14	5 x 7	10 x 10
*Specify Length (mm)	250 (2.5W) 500 (4.5W) 1000 (9.0W)	266 (2.5W) 516 (4.5W) 1016 (9.0W)	270 (2.5W) 520 (4.5W) 1020 (9.0W)
Connection	Jack	Wire	Wire
Material	Aluminium	PMMA	PMMA

*Specify Colour: ○ CW (Cool White), ○ WW (Warm White), ●●● RGB (Colour Changing). For Power Supplies see page 135, for RGB controllers see page 139

LED SHELF TAG



Standard Strips - Input Voltage: 24VDC | LED Chip: 3020 | CRI > 80 |

Colour Temperature: 5500K | Beam Angle: 180° Front Side Up, 120° Back Side Down

Code	Wattage	Lumens	Size
LST-1185-PW	11W	935lm	1000 x 48.6 x 12

With Butcher Strip - Input Voltage: 24VDC | LED Chip: 3020 | CRI > 80 |

Colour Temperature: 5500K | Beam Angle: 180° Front Side Up, 120° Back Side Down

LST-1185-PW-BL	11W	935lm	1000 x 48.6 x 12
-----------------------	-----	-------	------------------

SIDE VIEW LED STRIP LIGHTS IP20

SMD Side View Non-Weatherproof - 12VDC

- LED Type SMD335
- With self-adhesive backing

- Cutting length every 3rd LED
- Max pcs connected on same supply 2 x 5m



Code	No. of LEDs/m	Max Power	Lumen/m	LED Spacing	Length
SV60W-R335-*	60/m	4.8W/m	R:70 Y:80 G:120 B:60 CW:180 WW:180	16.7mm	5m
SV120W-R335-*	120/m	9.6W/m	R:140 Y:160 G:240 B:120 CW:360 WW:360	8.3mm	5m

*Add colour to code: ●R (Red), ●GN (Green), ●Y (Yellow), ●BL (Blue), ○CW (4000k), ○WW (3200k)

SIDE VIEW LED STRIP LIGHTS IP54

SMD Side View Weatherproof - 12VDC

- LED Type SMD335
- With self-adhesive backing

- Cutting length every 3rd LED
- Max pcs connected on same supply 2 x 5m



Code	No. of LEDs/m	Max Power	Lumen/m	LED Spacing	Length	PCB colour
SV60W-W335-*	60/m	4.8W/m	R:70 Y:80 G:120 B:60 CW:180 WW:180	16.7mm	5m	White
SV120W-W335-*	120/m	9.6W/m	R:140 Y:160 G:240 B:120 CW:360 WW:360	8.3mm	5m	White

*Add colour to code: ●R (Red), ●GN (Green), ●Y (Yellow), ●BL (Blue), ○CW (4000k), ○WW (3200k)

ZIG-ZAG LED FLEXIBLE STRIP 12VDC IP20

Foldable & bendable shaping | LED type SMD 2835 | With self-adhesive tape |
Cutting length every 3rd LED



Code	Max Power	Lumens	No. of LEDs	Length
ZZ60W-R2835-*	6.0W/m	480-660lm	60/m	5m
ZZ48W-R5050-RGBW ●●●○	15.38W/m	-	48/m	5m

*Add colour to code: ○WW (Warm White - 3000K), ○DL (Daylight - 5000K), ●R (Red), ●G (Green), ●B (Blue)

STRIP LIGHT CONNECTORS

Accessories for Non-Weatherproof SMD Strips

Code	Description	Pack Size
IMG-LJQ/10	2-Wire double sided connector for IMG-R30 strips	10
IMG-JXQ/10	2-Wire single-sided connector for IMG-R30 strips	10
IMG-ACC2-2/10	2-Wire white connector	10
SP2104	12V Male plug	1
SP2105	12V Female plug	1
IMG-ACC4-1	4-Wire connector for RGB strips	1
SL-CON16	DC female connector with 2 male connectors	1



Accessories for Weatherproof SMD Strips

Code	Description	Pack Size
SP104F	4 Wire 12V Male Plug	1
SP105F	4 Wire 12V Female Plug	1
IMG-ACC2-1F/5	Mini waterproof 2-wire connector IP65	5
IMG-ACEP2-F/10	Weatherproof end cap	10
IMG-ACHH-1/10	Flat transparent Mounting Clip for weatherproof LED strips	10
SL-CON11	2-Wire waterproof connector	1



Wiring Diagram for use of RGB Amplifier

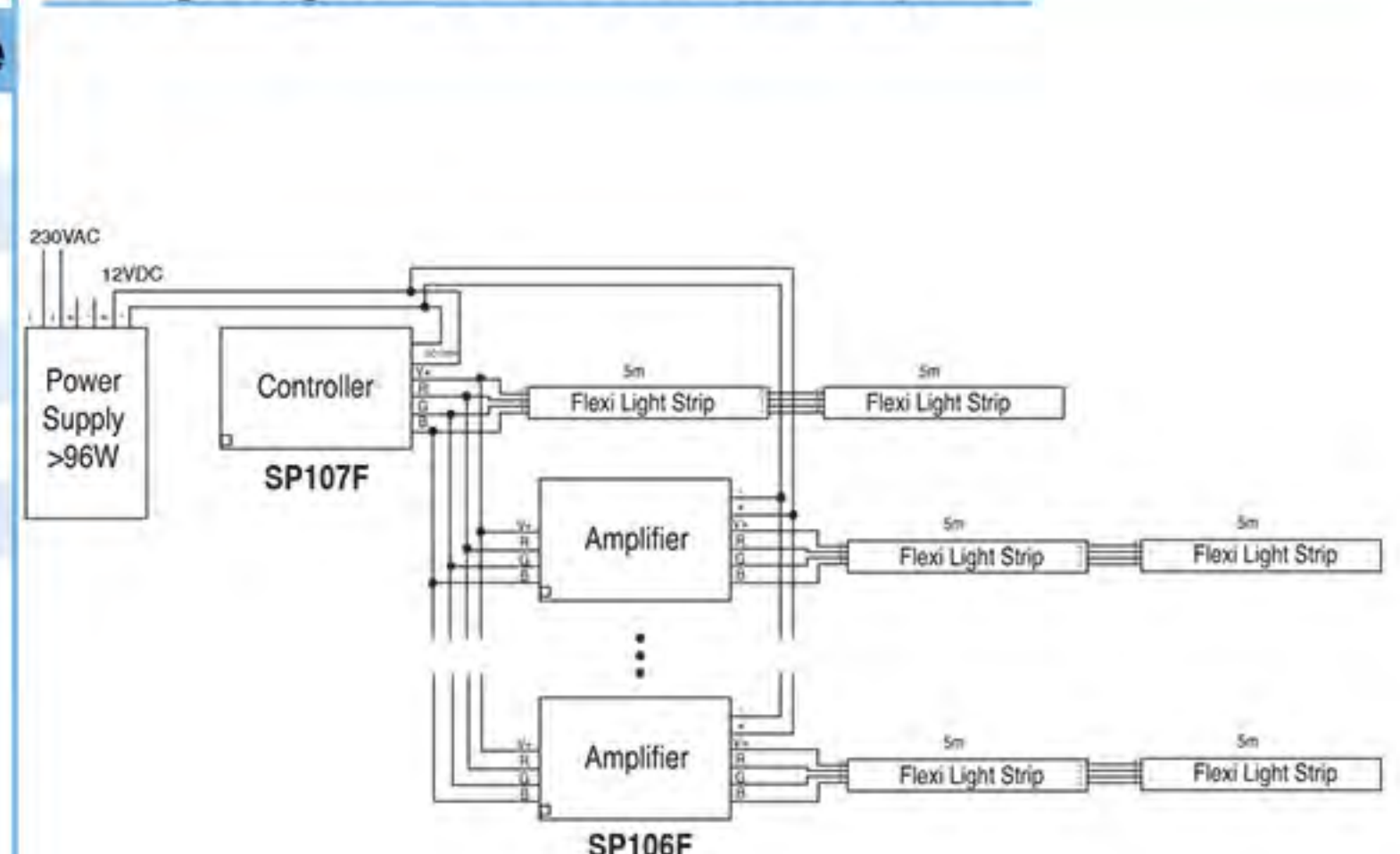

Commercial

LIGHTING

LED SIGNAGE BACK LIGHTING

**5 Year
Warranty**

ST2 Premium Range - IP65 Supply Voltage 12VDC | Epistar SMD 2835 | Over Moulded | **160° View Angle**

Code	Power/PC	Lumen/PC	Max Qty/Series	Dimensions (mm)	Spacing between modules	Length for 10 modules
BV-ST2-2-**-*	0.72W	44lm	30 Pcs	52 x 14 x 5.5	100mm	± 1620mm
BV-ST2-3-**-*	0.72W	66lm	30 Pcs	75.4 x 14 x 5.5	120mm	± 2074mm

*Add Colour to code: ○DL (Daylight 6500K), ●Y (Yellow), ●R (Red), ●G (Green), ●BL (Blue)

*Add Number of Modules to code: /10 (10 Pcs), /30 (30 Pcs)

**4 Year
Warranty**

ST6 Premium Range - IP65 Supply Voltage 12VDC | Epistar SMD 5730 High Lumen Performance | over moulded | **160° View Angle**

Code	Power/PC	Lumen/PC	Max Qty/Series	Dimensions (mm)	Spacing between modules	Length for 10 modules
BV-ST6-2-**-*	1.44W	80-90lm	30 Pcs	57.4 x 16.3 x 6.2	100mm	± 1674mm
BV-ST6-3-**-*	1.44W	120-135lm	30 Pcs	83 x 16.3 x 6.2	120mm	± 2150mm

*Add Colour to code: ○DL (Daylight 6500K), ●R (Red), ●G (Green), ●BL (Blue)

*Add Number of Modules to code: /10 (10 Pcs), /30 (30 Pcs)

**5 Year
Warranty**
NEW

M6 Range - IP65 Supply Voltage 12VDC | High quality 2835 chipset | High lumen efficacy 100lm/W | Constant current design to provide uniform lighting throughout | Single module cuttable | **175° Beam Angle**

Code	Power/PC	Lumen/PC	Max Qty/Series	Dimensions (mm)	Spacing between modules	Length for 10 modules
BV-M6-2-**-*	0.72W	72lm	50 Pcs	49 x 15 x 7.7	101.5mm	± 1505mm
BV-M6-3-**-*	1.1W	110lm	40 Pcs	70 x 15 x 7.7	115mm	± 1850mm

*Add Colour to code: ○DL (Daylight 6500K), ○SW (Sky White 10000K), ●R (Red), ●G (Green), ●BL (Blue)

*Add Number of Modules to code: 10 (10 Pcs), 30 (30 Pcs)

**2 Year
Warranty**

PJ2 Economy Range - IP67 Constant Voltage 12VDC | SMD 2835 | Colour Temp: 6500K | **120° View Angle**

Code	Power/PC	Lumen/PC	Max Qty/Series	Dimensions (mm)	Spacing between modules	Length for 10 modules
BV-PJ2-1*	0.096W	10lm	20 Pcs	14.2 x 8.4 x 5.3	40mm	± 582mm
BV-PJ2-2*	0.192W	20lm	20 Pcs	2 x 8.4 x 5.3	40mm	± 692mm
BV-PJ2-3*	0.288W	30lm	20 Pcs	54.2 x 8.4 x 5.3	60mm	± 1202mm

*Add Number of Modules to code: /10 (10 Pcs), /30 (30 Pcs)

LED SIGNAGE BACK LIGHTING

**3 Year
Warranty**



High Light Efficiency 3-in-1 RGB - IP67 Constant Voltage 12VDC | Epistar 3 in 1 SMD 5050 | Synchronized colour changing driven by LED Controller | **120° View Angle**

Code	Power/PC	Lumen/PC	Max Qty/Series	Dimensions (mm)	Spacing between modules	Length for 10 modules
BV-SMD-RGB*	0.72W	-	30 Pcs	70.6 x 12 x 6.8	82mm	± 1608mm

*Add Number of Modules to code: /10 (10 Pcs), /30 (30 Pcs)

**5 Year
Warranty**



SG2 High Output Premium Range - IP65 Constant Voltage 12VDC | SMD 2835 | Over Moulded | Colour Temp: 6500K | **160° View Angle**

Code	Power/PC	Lumen/PC	Max Qty/Series	Dimensions (mm)	Spacing between modules	Length for 10 modules
BV-SG2-144*	1.44W	230lm	20 Pcs	48 x 44.3 x 4	120mm	± 1800mm

*Add Number of Modules to code: /10 (10 Pcs), /30 (30 Pcs)

EDGE LIT LIGHT BOX HIGH POWER LED'S

Designed for use in double sided light box 160-400mm deep
Colour Temp: 6000K

Non-Weather Proof - 24VDC



Weather Proof IP65 - 24VDC



IP65 - 12VDC



Max 15 Modules in Series

Code	Z6003XBD-DL	Z6005XBD-DL	Z7003XBD-DL	Z7005XBD-DL	Z19-12-1
Power	6.8W	11W	6.8W	11W	3W
Lumen	660lm	1100lm	660lm	1100lm	280lm
No. of LED's	3	5	3	5	1
Size	298 x 28 x 16mm	518 x 28 x 16mm	323 x 30 x 22mm	543 x 30 x 22mm	66 x 42 x 14mm

BACK LIT LIGHT BOX HIGH POWER LED'S

• Back Lighting
• Applied to 5-10cm deep lighting box
• 175° View angle
• Samsung LED equipped
• Constant current, Aluminium PCB

Back Lit - 24VDC

6500K



• 160° View angle
• Samsung LED equipped
• Constant current
• Min cutting length every 3 modules

Back Lit - 24VDC

6500K



Code	YD7-3.0-2403	YD7-3.0-4806	YD7-3.0-9612	Code	AL-3300-24-3
Power	3.6W	7.2W	14.4W	Power	4.8W/ 3 LED's
Lumen	357lm	708lm	1375lm	Lumen	390lm
No. of LED's	3	6	12	No. of LED's	30
Size	240 x 20mm	480 x 20mm	960 x 20mm	Length	5.250 meters

2-year warranty on all LED products & 1-year warranty on battery-operated products, unless specified.
LED warranty void without surge protection. Refer to page 128

LED FLOOR & WALL LIGHTS

Supply Voltage: 230VAC

3 light kit



3 light kit



3 light kit



Kits c/w 230VAC Transformer and 3-in-1 connector

Code	CIE-L001-*	CIE-L002-*	LED-HH03/3-*
Size (mm)	95 x 95 x 125	Ø95 x 125	Ø59 x 50
LED's/Light	4 x 0.15W (0.6W)	6 x 0.1W (0.6W)	5 x 0.1W (0.5W)
IP Rating	IP44	IP44	IP65
Lumen/Lamp	13	13	9
Material	Stainless Steel	Stainless Steel	Aluminium

*Add colour to code: ○ CW (Cool White), ○ WW (Warm White), ● BL (Blue), ● Y (Yellow), ● GN (Green), ● R (Red)

Supply Voltage: 230VAC

3 light kit



5 light kit (35mm Ø cutout)
For 5 light kit 10VA Transformer



3 light kit



Kits c/w 230VAC Transformer and 3-in-1 connector

Code	HLF01702-*	LED-P03C/5- Kit	HLG01201- Single light	HLG01902-*
Size (mm)	Ø30 x 15	Ø40 x 57		73 x 73 x 18
LED's/Light	1W	6 x 0.08W (0.5W)		12 x 0.04W (0.5W)
IP Rating	IP20	IP65		IP20
Lumen/Lamp	138	15		38
Material	Plastic / Clear PC	Aluminium / Clear Glass		Nickel / Matt Glass

*Add colour to code:
○ CW (Cool White), ● BL (Blue)

*Add colour to code: ○ CW (Cool White), ○ WW (Warm White), ● BL (Blue), ● Y (Yellow), ● GN (Green), ● R (Red)

*CW, WW & BL available

Supply Voltage: 230VAC

5 light kit



3 light kit



3 light kit



Kits c/w 230VAC Transformer and 3-in-1 connector

Code	HLG01402-*	HLG01604-*	HLG02102-*
Size (mm)	40 x 40 x 44	59 x 59 x 50	Ø55 x 8
LED's/Light	6 x 0.08W (0.5W)	5 x 0.1W (0.5W)	3 x 0.5W (1.5W)
IP Rating	IP65	IP65	IP65
Lumen/Lamp	15	9	46
Material	Aluminium	Aluminium	Aluminium

*Add colour to code: ○ CW (Cool White), ○ WW (Warm White), ● BL (Blue), ● Y (Yellow), ● GN (Green), ● R (Red)

Accessories



Outdoor Transformers IP68



Code	3-IN-1	6-IN-1	TRF24/6	TRF24/20	TRF24/30
Description	Spare 3 in 1 connector for kits	Spare 6 in 1 connector for kits	230V/24VAC 6VA	230V/24VAC 20VA	230V/24VAC 30VA

LED DECK LIGHTS

Supply Volts: 12VDC
Low Profile: 9mm

IP67 Single Light



IP67



6 Pcs Kit comes with T-Cable, Power Supply, Controller (RGB)



Code	SC-B101B*	SC-B101C	SC-B102B*	SC-B102C	SC-6B101B-CW	SC-6B101C-RGB	SC-6B102B-CW	SC-6B102C-RGB
Power	0.5W	0.7W	0.6W	0.9W	0.5W	0.7W	0.6W	0.9W
No. of LEDs	1pc				6pcs Kit			
LED Colour	Single	RGB	Single	RGB	Cool White	RGB	Cool White	RGB
Cut-Out (mm)	Ø51mm		51 x 51mm		Ø51mm		51 x 51mm	
Size (mm)	Ø58 x 9		58 x 58 x 9		Ø58 x 9		58 x 58 x 9	
Material	304 Stainless Steel				304 Stainless Steel			
Connection	1m Cable with male plug				1m Cable with male plug			

*Add colour to code: ● R (Red), ● B (Blue), ● Y (Yellow), ● G (Green), ○ CW (Cool White), ○ WW (Warm White)

Code	SC-B103B*	SC-B104B*	SC-B104C	SC-B105B*	SC-B106B*
Power	0.4W	0.4W		0.3W	0.23W
No. of LEDs	1pcs	1pcs		1pcs	1pcs
LED Colour	Single	Single	RGB	Single	Single
Cut-Out (mm)	Ø51mm	Ø33mm		Ø24mm	Ø24mm
Size (mm)	Ø58 x 9	Ø40 x 19		Ø30 x 19	Ø35 x 31
Material	304 Stainless steel	304 Stainless steel		304 Stainless steel	Die Cast Aluminium
Connection	1m cable with Male plug	2 x 1m cable with Male plug & Female plug		2 x 1m cable with Male plug & Female plug	1m cable with Female plug

*Add colour to code: ● R (Red), ● B (Blue), ● Y (Yellow), ● G (Green), ○ CW (Cool White 6500K), ○ WW (Warm White)

Connectors & Accessories

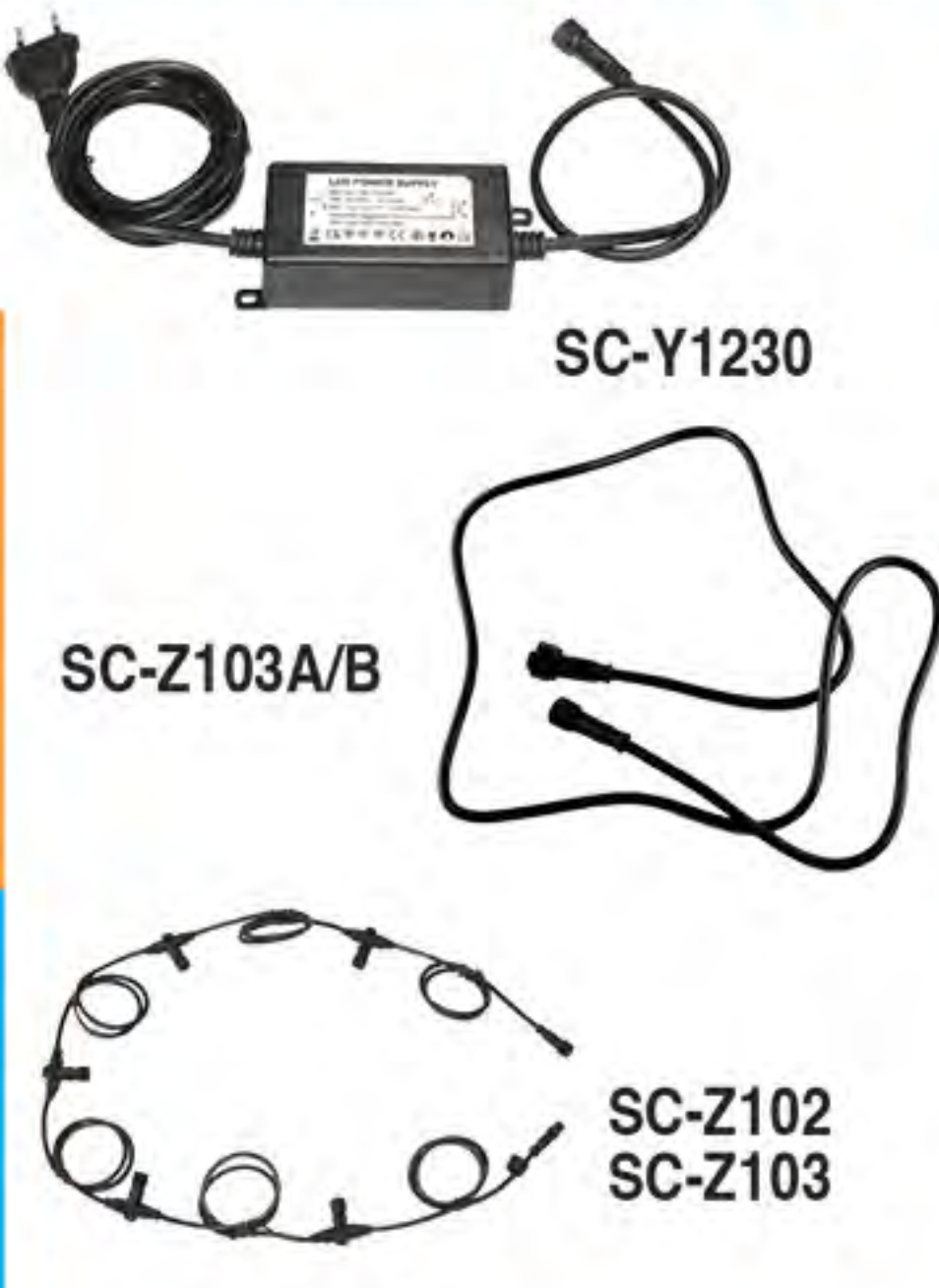

Code 2 Wire (Single Colour)	Code 4 Wire (Colour Changing)	Description
SC-Z103A-3M	SC-Z103B-3M	3m Cable with male & female Connectors
SC-Z102	SC-Z103	5pcs "T" Connection Cable - 0.5m between pieces
SC-Z105A	SC-Z105B	Waterproof "T" Connector
SC-Z106A	SC-Z106B	Waterproof Connection Box
	SC-Y1230	12VDC power supply for use with Deck lights 0.3m cable with female plug. Supply voltage: 90-264VAC Max loading: 30W (2.5A) 12VDC
-	SC-Z101	RGB controller for use with deck lights with 0.5m input and output cables IP67



Outdoor

LIGHTING

SOLAR IN-GROUND LIGHTS

SOLAR	Stainless Steel In-ground Series IP44				In-ground IP68	Paving Lamp IP44
Batteries Included						Aluminium
SOL2						
Code	RW2LED-120	RW3LED-120	SDDM002	SDDM002-2	ZH-03-W	RW-SLR001
Size (mm)	Ø120 x 35D	Ø120 x 35D	125 x 125	125 x 125	Ø50 x 35	Ø120 x 35D
Type	2 x White LED	3 x White LED	4 x White LED	RGB colour changing	1 x White LED	1 x LED
Batteries	1 x NiMh 600mA	2 x NiMh 600mA	1 x NiMh 600mAh	1 x NiMh 600mAh	1 x NiMh 350mAh	1 x NiMh 600mA

2-year warranty on all LED products & 1-year warranty on battery-operated products, unless specified. LED warranty void without surge protection. Refer to page 128

EMPTY INGROUND LIGHTS - IP67

Lamps excluded | Stainless Steel

Code	MXD-100-1	MXD-100-3	MXD-100-6	MXD-120-1F
Lamp Holder	MR16	MR16	MR16	MR16
Size	Ø100 x 120	Ø100 x 120	Ø100 x 120	Ø120 x 130
Hole Size (mm)	Ø90 x 120	Ø90 x 120	Ø90 x 120	Ø98 x 130

Code	NB1033-D	NB1033-A	NB1033-C
Lamp Holder	MR16	GU10	E27
Size	Ø100 x 156	98 x 98 x 147	Ø154 x 255
Hole Size (mm)	Ø90 x 156	Ø88 x 147	Ø144 x 255

LED INGROUND LIGHTS IP66

Supply Voltage: 230VAC | Material: Stainless Steel

	Fixed 	Fixed 	Angle: 30° (Fixed)
Code	NCC-180C-*	NCC-260C-*	NCC-250-3-*
LED	10W	30W	9W
Lumens	1000lm	3000lm	900lm
Size (mm)	Ø180 x 115	Ø260 x 120	Ø250 x 210
Hole Size (mm)	Ø170 x 120	Ø240 x 120	Ø240 x 150

	Tiltable 	Fixed 	Fixed
Code	XGN-T260-*	MXD-100-7-*	MXD-100-8-*
LED	18W	3W	3W
Lumens	1800lm	300lm	300lm
Size (mm)	Ø260 x 325	Ø100 x 75	Ø100 x 75
Hole Size (mm)	Ø248 x 335	Ø90 x 75	Ø90 x 75

	Tiltable 		
Code	XGN-C210-*	LED-3739/4-*	WL11009A-*
LED	7W	28 X 0.1W (2.3W)	12 x 0.08W (1W)
Lumens	700lm	84lm	10lm
Size (mm)	Ø210 x 270	Ø145 x 130	100Ø x 80D
Hole Size (mm)	Ø195 x 280	Ø135 x 130	Ø90 x 80

Add colour to code: *○ CW (Cool White), ○ WW (Warm White)
 *○ WH (White), ● BL (Blue), ● Y (Yellow), ● GN (Green), ● R (Red)
 *○ CW (Cool White), ○ WW (Warm White), ● R (Red), ● GN (Green), ● BL (Blue), ● Y (Yellow)
 *○ CW (Cool White), ● BL (Blue)

2-year warranty on all LED products & 1-year warranty on battery-operated products, unless specified. LED warranty void without surge protection. Refer to page 128

GARDEN SPOT LIGHTS

Spot Lights

Lamps excluded



Ø97 x H155mm



Ø63 x H157 x D77mm

Code	NB1036	NB1057-D	C7033-ST
Lamp	Max. 50W 12V MR16	Max. 75W PAR38 (ACL91)	MR16 35W 12V
Lamp Holder	MR16	E27	GU 5.3
IP Rating	IP65	IP65	IP54
Material	Die Cast Aluminium body	Stainless Steel	Stainless Steel

EMPTY GARDEN SPIKE LIGHTS

Lamps excluded



IP65



IP65



IP65



IP65



IP65

Code	NB1038	NB1036-B	NB1037	NB1051	NB1052
Lamp	Max. 50W 12V MR16	Max. 50W 12V MR16	Max. 50W 12V MR16	Max. 50W 12V MR16	Max. 50W 12V MR16
Lamp Holder	MR16	MR16	MR16	MR16	MR16
Material	Die Cast Aluminium body	Die Cast Aluminium body	Die Cast Aluminium body	Die Cast Aluminium body	Die Cast Aluminium body

Outdoor

LIGHTING



PAR38
IP44



IP44



IP44



IP65

Code	NB1070	NB1074	EL200660	C800-504
Lamp	Max. 80W	PL-13-CW	Max. 120W	3 x MR16 20W
Lamp Holder	E27	G23	2 x E27	GU4/GZ4
Material	ABS Plastic	ABS Plastic	Thermo Plastic	Die-cast Aluminium

2-year warranty on all LED products & 1-year warranty on battery-operated products, unless specified.
LED warranty void without surge protection. Refer to page 128

GARDEN SPIKE LIGHTS

Supply Voltage: 230VAC	<p>IP65</p>  <p>Optional lenses: ● RW-LED-4-LENS-BL ● RW-LED-4-LENS-R ● RW-LED-4-LENS-G</p>	<p>IP65 c/w 12V transformer</p> 	<p>IP68</p> 	<p>IP20 S.Steel + Glass Trim</p> 	<p>Plastic Spot Lamp</p> <p>IP67 Battery: 1 x NiMH 600mA</p> 
Code	RW-LED-4-CW	RW-LED-18-*	LED-9030-*	LED-3031AS-*	RW-SLP006
LED's	4W	3 x 6W	3 x 1 (3W)	3 x 1W (3W)	1 x LED
Lumen	220lm	280lm x 3	270lm	90lm	150lm
Size (mm)	Ø72 x 257	Ø72 x 257	Ø98 x 320	Ø65 x 350	160 x 85 x 330

*Add colour to code: ○ CW (Cool White), ● BL (Blue), ● R (Red), ● G (Green), ● Y (Yellow)

SOLAR GARDEN LIGHTS IP44

<p>SOLAR</p> <ul style="list-style-type: none"> Batteries Included Height does not include spike <p>SOL2</p>							
Code	RW-SF-03-8	RW-SF-03-2	RW-SF-02-1	RW-SF-03-4	RW-SLS004	E2009	CON-SOLAR
Size (mm)	320H x 115Ø	455H x 120Ø	605H x 138Ø	325H x 125Ø	360 x 115Ø	390H x 130Ø	1 Litre Consol Jar
Type	1 x LED	1 x LED	1 x LED	1 x LED	1 x LED	1 x LED	4 x LED
Batteries:	1 x NiMH 600mAh	1 x NiMH 600mAh	1 x NiMH 600mAh	1 x NiMH 600mAh	1 x NiMH 600mAh	1 x NiMH 600mAh	2x1.2V 600mAh AAA
Material	Plastic	Plastic	Plastic	Plastic	Stainless Steel	Stainless Steel	Glass
<p>SOLAR</p> <ul style="list-style-type: none"> Batteries Included Height does not include spike <p>SOL2</p>					<p>Motion Sensor 110° Max. 5m. Light Time 38s/350 Times. 6500K</p> 	<p>Rechargeable</p> 	<p>3in1</p> <p>With Mosquito Repeller Lawn & Table Light</p> 
Code	RW-SLS001	RW-SLS002	RW-SLS003	SDBX115	S-1718	ESL-10	SL-04M
Size (mm)	307.5H x 150Ø	480H x 170Ø	365H x 125Ø	420H x 170Ø	570 x 115 x 90	800mm (H)	510(H) x 110Ø
Type	1 x LED	1 x LED	1 x LED	1 x LED	15 LEDs (200lm)	1 x LED	1 x LED
Batteries:	1 x NiMH 600mAh	1 x NiMH 600mAh	1 x NiMH 600mAh	1 x NiMH 600mAh	1x3.7V 1800mAh 18650	Li-ion Battery	Li-ion Battery 450mAh
Material	Stainless Steel	Stainless Steel	Stainless Steel	Stainless Steel	PC + ABS	PC & Aluminium	Stainless Steel

2-year warranty on all LED products & 1-year warranty on battery-operated products, unless specified. LED warranty void without surge protection. Refer to page 128

STAINLESS STEEL BOLLARDS

Supply Voltage: 230VAC

* Add Colour to code



Code	TL-ST-06E	TL-ST-06D	TL-ST-06C	KH836-SS	KH834-PSH	CIE-L006-300-*
LEDs	2 x 6W	2 x 6W	2 x 6W	24 x 0.12W (2.88W)	16 x 0.12W (1.92W)	16 x 0.12W (1.92W)
Lumen	550lm	550lm	550lm	66lm	48lm	550lm
IP Rating	IP44	IP44	IP44	IP44	IP44	IP44
Size (mm)	Ø76 x 870	Ø76 x 675	Ø76 x 520	Ø76 x 300	Ø80 x 400	Ø76 x 520
Colour Temp	4200K	4200K	4200K	4200K	4200K	*CW / ●R / ●GN / ●BL / ●Y

Supply Voltage: 230VAC
Order Lamps separately



Code	C300-224-650	C300-224	YF-B5207	CIE007-1-1050	CIE007-2H	C300-216
Lamp	60W Max	60W Max	60W Max	60W Max	2x60W Max	40W Max
Lamp Holder	E27	E27	E27	E27	E27	E27
IP Rating	IP44	IP44	IP44	IP44	IP44	IP44
Size (mm)	Ø200 x 650	Ø250 x 1175	Ø250 x 800	Ø200 x 1050	Ø200 x 1180	Ø120 x 800

Supply Voltage: 230VAC
Material: PP Plastic & Stainless Steel
Order Lamps separately



Code	CIE007-500	CIE007-1-500	CIE016-600	CIE014S-450	CIE014-450
Lamp	100W Max	100W Max	60W Max	60W Max	60W Max
Lamp Holder	E27	E27	E27	E27	E27
IP Rating	IP44	IP44	IP44	IP44	IP44
Size (mm)	Ø200 x 380	Ø200 x 380	Ø76 x 600	Ø76 x 450	Ø75 x 450

2-year warranty on all LED products & 1-year warranty on battery-operated products, unless specified.
LED warranty void without surge protection. Refer to page 128

EMPTY BOLLARDS

Supply Voltage:
230VAC
Die-cast
Aluminium
Bodies
Lamps excluded
IP44



Code	YSC-3011	YSC-3030	YSC-3039	YSC-3048	YSC-3024
Lamp Base	E27 (18W Max.)	E27 (18W Max.)	E27 (18W Max.)	E27 (18W Max.)	E27 (18W Max.)
IP Rating	IP44	IP44	IP44	IP44	IP44
Size (mm)	158 x 800	200 x 100 x 700	Ø160 x 800	Ø160 x 740	160 x 700

Supply Voltage:
230VAC
Die-cast
Aluminium
Bodies
Lamps excluded



Code	YSC-3028	YSC-3078	YSC-3085	NB3077
Lamp Base	E27 (18W Max.)	E27 (18W Max.)	E27 (18W Max.)	E27 (100W Max.)
IP Rating	IP44	IP44	IP44	IP44
Size (mm)	160 x 750	Ø280 x 600	Ø220 x 600	Ø205 x 650

Supply Voltage:
230VAC
Die-cast
Aluminium
Bodies
Lamps excluded



Code	NB3078	NY21836R	NY11836R*
Lamp Base	E27	2 x E27/75W	E27/75W
IP Rating	IP44	IP54	IP54
Size (mm)	Ø170 x 650	260 x 990	124 x 990
			Add SC to code for smokey clear lense

DIE-CAST ALUMINIUM BOLLARDS

Supply Voltage:
230VAC
Die Cast
Aluminium
Colour
Temp.:
4000K
Dark Grey

LED



LED



LED



LED



Code	YSC-1007	YSC-1004	YSC-1000	YSC-1002
Wattage	5W	5W	5W	5W
Lumens	500lm	500lm	500lm	500lm
IP Rating	IP54	IP54	IP54	IP54
Size (mm)	76 x 76 x 800	50 x 120 x 800	60 x 102 x 800	100 x 160 x 850

2-year warranty on all LED products & 1-year warranty on battery-operated products, unless specified.
LED warranty void without surge protection. Refer to page 128

POST TOPS

Supply Voltage: 230VAC
Lamps Excluded
Pole Included
Material: Steel



Code	LH-5004G	LH-5004G-2.4M	LH-5004-3G	LH-5029G	LH-5029-2G	LH-5029-3G
Lamp	E27/100W	E27/100W	3 x E27/100W	E27/60W	2 x E27/60W	3 x E27/60W
IP Rating	IP44	IP44	IP44	IP54	IP54	IP54
Size (mm)	1200(H)	2400(H)	2280(H)	2360(H)	2360(H)	2360(H)

POST TOP HEADS IP55

Input Voltage: 220 - 240VAC

LED



Colour Temp: 6000K

LED



Colour Temp: 6000K

LED



Colour Temp: 6000K

LED



Colour Temp: 4200K

LED



Colour Temp: 4200K

Code	01-006-LED	RW-GL-LED-30W	RW-GL-LED-50W	AG-008	CET-118C-100W-CW
Max Power	40W	30W	50W	50W	100W
Lumens	4000lm	3000lm	5000lm	5400lm	12000lm
Size (mm)	Ø700 x 460	Ø160 x 600	Ø485 x 695	Ø500 x 660	Ø423 x 520
Material	Die Cast Aluminium	Die Cast Aluminium	Die Cast Aluminium	Die Cast Aluminium	Die Cast Aluminium
Entry	Ø76	Ø76	Ø76	Ø60	Ø75

Input Voltage: 220 - 240VAC



Empty



Code	YZTH-859-EMPTY	01-006-*	YZTH-862-*	521LED-MT
Max Power	70W-150W	70W-150W	70W-150W	Max. 150W
Lamp Holder	E27	E27	E27	E27
Size (mm)	Ø738 x 560	Ø700 x 460	Ø380 x 333	Ø400
Material	Die Cast Aluminium	Die Cast Aluminium	Die Cast Aluminium	Die Cast Aluminium
Entry	Ø76	Ø76	Ø60	Ø76

* Add type of switch gear required: **70W** (Metal Halide), **150W** (Metal Halide), **EMPTY** (No switch gear)

POLES



Code	POLE-3.5M-76
Pole length	3500mm
Pole Top Ø	76mm
Material	Galvanised Steel

2-year warranty on all LED products & 1-year warranty on battery-operated products, unless specified.
LED warranty void without surge protection. Refer to page 128

LED UNDERWATER LIGHTS IP68

Supply volts: 12VDC



Supply volts: 12VDC



Supply volts: 12V



Supply volts: 12V RGB
c/w remote



Code	HLB01901-12VDC-*	HLB01801-12VDC-*	GLD005-*	GLD-RGB-10W
Power	6W	9W	4.5W	10W
Lumen	600lm	900lm	45lm	750lm
Size (mm)	Ø120 x 155	Ø180 x 145	Ø120	Ø75 x 91
Material	304 Stainless Steel	304 Stainless Steel	ABS	Aluminium
	*Add colour to code: ● WW (Warm White), ● BL (Blue)	*Add colour to code: ● WW (Warm White), ○ CW (Cool White), ● BL (Blue)	*Add colour to code: ○ W (White), ● R (Red), ● G (Green), ● BL (Blue), ●●● M (RGB)	



Input Voltage: 24VAC/DC | c/w 2 Meter cable

Code	Size (mm)	Watts	No of LEDs
UD14-M	Ø53 x 35	1.5	15
UD15-*	Ø53 x 35	1.5	15

*Add colour to code: ● **R**, ● **G**, ● **B**, ○ **W**, ● **Y**, ● **P** -M = Multi-colour (Full colour changing ●●●)

UNDERWATER LIGHTS IP68

Lamps & Transformers Excluded



Code	C7062	C7052	C7162	LH5001-9A
Lamp	MR16 35W 12V	80W 230V	MR16 35W 12V	MR16 50W 12V
Lamp Type	GU5.3	E27	GU5.3	GU5.3
Material	Stainless Steel	Stainless Steel	Stainless Steel	PBT
Size (mm)	Ø82 x 152 x 110	Ø155 x 260 x 200	Ø82 x 300 x 110	Ø85 x 110

Outdoor

POOL LIGHTS

Recessed Mounting

Supply Voltage: 12VAC



Surface Mount



Code	PL100-10	PL300-10	PLP300-10	PS100-10
Power	100W	300W	300W	100W
Lamp Type	PAR36 (incl.)	PAR56 (incl.)	PAR56 (incl.)	2 X JC (G6.35) (incl.)
Size (mm)	Ø165 x 110	Ø270 x 125	Ø270 x 125	Ø280 x 50
Spare Lamp	Lamp not replaceable	ACL81	ACL81	-

LIGHTING

POOL LIGHTS

c/w Standard 10m cable

Supply Voltage:
12VAC

LED - Surface Mounting



LED S/Steel - c/w internal controller

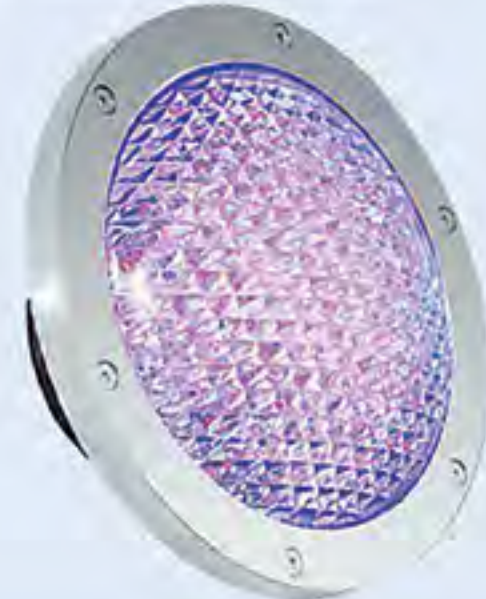

Plastic Floating Lamps IP67

SOL2

SOLAR



Battery: 1 x NiMh 600mA

SOLAR



Battery: 1 x NiMh 600mA

Code	PAR56-270-BL	CM-P007-M	RW-SLB003	RW-SLB002
Power	15W	12-16W	1W	1W
Lamp Type	Blue LEDs	LED (RGB)	2 x LED	2 x LED
Size (mm)	Ø290 x 60	Ø 210mm	Ø120	Ø160



LED PAR 56 & PAR46 Lamp - Supply Volts - 12VAC (Suitable for Swimming Pools)

Code	Power	Lumen (MCD)	*Add Colour to Code:
HG-PAR56-*	18W	R & Y=1500-2500, G=7000-9000 B=2000-2500, W=6000-8000	●R / ●G / ●Y / ●●● M (RGB)
HGPAR56AUTO	18W Auto changing	RGB=2000-3500	●●● Auto

Remote supplied with M (Multicolour) only

LED AQUA POOL LIGHTS IP68

Surface Mount



Code	Wattage	Voltage	Lumen	Beam Angle	Size (mm)
P120-*	20W (1700mA)	12-24VAC/DC	1500lm	120°	Ø250 x 50

*Add colour to code: ○ W (White), ● B (Blue), ●●● RGB (Colour Changing)

PAR56 Retrofit Lamp



Code	Wattage	Voltage	Lumen	Beam Angle	Size (mm)
PAR120-*	20W (1700mA)	12-24VAC/DC	1500lm	120°	Ø180 x 77

*Add colour to code: ○ W (White), ● B (Blue), ●●● RGB (Colour Changing)

Spa and Jacuzzi LED



Code	Wattage	Voltage	Lumen	Beam Angle	Size (mm)
P50SPA-B	4W	12VAC/DC	400lm	60 - 90°	Ø110 x 63

NEW



Back

Front

Aim Flow Powered Pool & Spa LED - Jet Hole Mounting | No External Power Required - Self Generating

Code	Wattage	Voltage	Lumen	Beam Angle	Size (mm)
JHM-L-*	0,1W	Self Driven	10lm	60-90° (2m)	Ø45 x 40

*Add colour to code: ○ CW (Cool White), ● BL (Blue), ● GN (Green)

Accessories

Code	Description
PLA05	Output 12V, 150VA, Outdoor Transformer, 1-6 pieces
PLA06	10A Underwater Connector
PLA07	PAR56 Pool Light Plastic Case Housing
PLA09	External R.F Remote System, Control device power on/off, Select programme, Synchrony programme



2-year warranty on all LED products & 1-year warranty on battery-operated products, unless specified. LED warranty void without surge protection. Refer to page 128

FIBRE OPTIC POOL LIGHTING

Solid Core Fibre Optic Side Light

- Economic replacement of neon lighting
- Safe – no safety shield required
- Neutral colour fibre, colour added with light engine

Minimum bend radius: 4 x core diameter

Ambient: -20 to +120°C

Loss: 6%/m

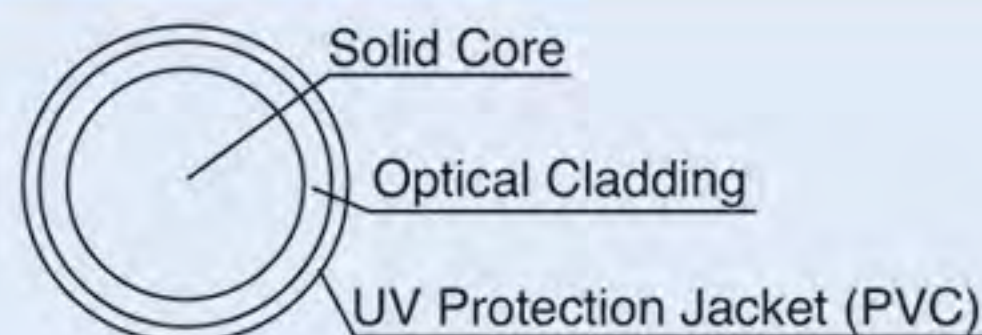

Solid Core Side Light

Code	Core Ø	Outside Ø	Length	Shielding Colour
OFS-60-30	6mm	8.8mm	30m	Clear
OFS-100-30	10mm	13.0mm	30m	Clear

Multi-String Side Light

MOFS-3-14-30	–	8.6mm	30m	Clear
MOFS-6-14-30	–	12.6mm	30m	Clear

Crystifiber Solid Core Side Light

COFS-60-30	6mm	9.4mm	30m	Clear
COFS-100-30	10mm	14.2mm	30m	Clear

Used for lighting of swimming pools, spas and building outlining



Accessories

Code	Suitable for	Size	Description
NTS-009	OFS-60/MOFS-6/COFS-60	8-9mm	Extended Clip
NTS-012	OFS-100/COFS-100	12-13mm	Extended Clip
OF-2-9	OFS-6/COFS-6	9mm	Crocodile Clip
OF-1-9	OFS-6/MOFS-6/COFS-60	9mm	Clear Channel Plastic 1.8m
OF-1-13	OFS-100/COFS-100	13mm	Clear Channel Plastic 1.8m
OF-3	OFS-60/100, COFS-60/100	–	Fibre Cutter for Solid Core
OF-4	MOFS-6	–	Fibre Cutter for Multi-string



- H-50/100**
- Wall Mounting
 - Wired Remote

- R-150**
- Continuous change in colour
 - Colour changed by stepping
 - Fixed colour display



- R-150**
- Colour Wheels

- R-150 DMX M/S/D**
- Programmable VID DMX Controller
 - Sound activated
 - Dimming
 - Rainbow effect

Light Engines (Indoor) 230V

Code	Lamp	Motor	Lamp Life
H-50	Halogen 12V 50W	2-5rpm	4000hrs
H-100	Halogen 12V 100W	2.5rpm	4000hrs
R-150	HQI-R 150W	Stepping	6000hrs
R-150 DMX M/S/D	HQI-R 150W	Stepping	6000hrs
SRC-144	DMX Controller	–	–



DMX Controller

- 54 Channels DMX Output up to 9 projectors
- 4 Digit LED Display showing program/run speed/cross time
- 9 Programs and each program up to 50 steps
- DMX Signal: 3 pin XLR female x1
- Power input: DC 9V-12V 500mA (Adaptor is included)



Fibre Optic Kits

Code	Light Engine	Fibre Size	No. of Fibres	Length of Fibres	End Piece
FRP-001	LED MINI	0.75mm	155	2m	–
FRP-002	H-20	0.75mm	25 x 4	2, 3, 4, 5m	FO-033
FRP-003	H-35	1.0mm	120	2m	FO-034
FRP-004	H-50 DMX	1.0mm	32	8x0.8m, 6x1.2m, 6x1.8m, 6x2.2m, 6x2.5m	FECU-10-1.0
FRP-005	H-50T	0.75mm	MOFSSS-14 x 1	10m	–

LED FOOTLIGHTS



HHB-WF-01



HHB-WF-01-S

Standard Foot Light IP65 - Input Voltage: 230VAC | Beam Angle: 90° | CRI ≥ 80 | Die Cast Aluminium & Glass | Wall Box excluded, for wall box see **BEL-B1**

Code	Wattage	Lumens	Cut Out	Size (mm)
HHB-WF-01-**-*	1.5W	45lm	86 x 86mm	95 x 95mm

Motion Sensor Foot Light IP65 - Input Voltage: 230VAC | Beam Angle: 90° | CRI ≥ 80 | Sensing Distance: 3m | Sensor Angle: 100° | Time Delay: 3 seconds | Die Cast Aluminium & Glass | Wall Box excluded, for wall box see **BEL-B1**

Code	Wattage	Lumens	Lumens	Size (mm)
HHB-WF-01-S-**-*	1.5W	45lm	86 x 86mm	95 x 95mm

*Add body colour to code: **WH** (White), **BK** (Black), **G** (Gold)

*Add colour to code: ○ **WW** (Warm White - 2700K), ○ **CW** (Cool White - 4000K)



Sensor / Emergency Foot Light IP20 - Easy to Install and fits all 4 x 2 wall boxes (wall box excluded) | Dimensions: 115 x 80 x 28mm

Code	Wattage	Lumens	Battery	Backup Time	Function
EMG-FP-NMM-*	2W	160lm	1 x 0.7Ah Li-ion	3h	nm/m
EMG-FP-S-*	2W	160lm	-	-	Sensor

*Add face plate colour to code: ○ **WH** (White), ● **BK** (Black), ● **S** (Silver)



SQ06

Square LED Lights

Bezel Colour	Code	Size (mm)	Material	IP	Light Output	Power Consumption	LED
Stainless Steel	SQ06-*	103L x 103W x 63H	Stainless Steel	IP65	20W	1.6W	30

* Add colour to code: ○ **WW** (Warm White), ● **R**, ● **G**, ● **B**.

* Add voltage to code: **12V AC/DC**, **230VAC**. For 12V LED power supply see page 139-140



RD02

RD04

RD05/6

Round LED Lights with removable bezel

*Can be used underwater

Bezel Colour	Code	Size (mm)	Material	IP	Light Output	Power Consumption	LED
WH, BK, C	RD02-*	Ø122x53	Plastic	IP68*	20W	1.44W	30
	RD02B-*	*Bezel colour: W (White), G (Gold), C (Chrome), BK (Black), to be ordered separately					

*Add colour to code: ○ **WW** (Warm White), ● **R**, ● **G**, ● **B**.

*Add voltage to code: **12V AC/DC**, **230VAC**. For 12V LED power supply see page 139-140
RD02 supplied standard with white bezel. Other colour bezel to be ordered separately.

Round LED Lights

White	RD04-*	Ø69x22.5	Aluminium	IP25	11W	0.9W	15
Chrome	RD05-*	Ø104x21	Aluminium	IP44	30W	2.9W	48
Chrome	RD06-*	Ø93x21	Aluminium	IP44	20W	1.44W	30

*Add colour to code: ○ **WW** (Warm White), ● **R**, ● **G**, ● **B**.

*Add voltage to code: **12V AC/DC**, **230VAC**. For 12V LED power supply see page 139-140

LED RECESSED WALL LIGHTS

Supply Voltage: 230VAC



Aluminium



Aluminium



Aluminium



Aluminium



Code	LED-J01*	LED-J02*	LED-J04*	LED-9009**	WL11027-**	WL11028-**
LED's	14 x 0.08W (1.2W)	14 x 0.08W (1.2W)	18 x 0.08W (1.5W)	2 x 1W	4W	4W
Lumens	32lm	32lm	36lm	90lm	120lm	120lm
IP Rating	IP54	IP54	IP54	IP54	IP44	IP44
Size (mm)	Ø126 x 65.5	65.5 x 126 x 126	138 x 140 x 94	132 x 62	165 x 125 x 105	165 x 125 x 105

*Add colour to code: ○ **CW** (Cool White), ○ **WW** (Warm White) *Add colour to code: ○ **CW** (Cool White), ● **R** (Red), ● **GN** (Green), ● **BL** (Blue), ● **Y** (Yellow)

Add colour to code: ○ **CW (Cool White), ○ **WW** (Warm White), ● **BL** (Blue), ● **R** (Red)

Outdoor

LIGHTING

LED RECESSED WALL LIGHTS

Supply Voltage: 230VAC

	<td> <td> NEW</td> </td>	<td> NEW</td>	NEW		
	c/w Wall Box	c/w Wall Box	c/w Wall Box	c/w Wall Box	
Code	FG07401-*	FG07501-*	FG07601-*	FG07701-*	RW-OCL-02
Lamp Holder	1.5W LED	1.5W LED	3.5W LED	3.5W LED	E27 Max. 60W
Lumens	75lm	55lm	195lm	187lm	N/A
IP Rating	IP65	IP65	IP65	IP65	IP44
Size (mm)	80 x 80 x 61	123 x 53 x 61	135 x 135 x 65	205 x 95 x 65	233 x 101 x 83
Material	ST304 + & Aluminium				Die Cast Aluminium

*Add colour to code: ○ CW (Cool White), ○ WW (Warm White)

Supply Voltage: 230VAC

	<td> <td> NEW</td> </td>	<td> NEW</td>	NEW		
	c/w Wall Box	c/w Wall Box	c/w Wall Box	c/w Wall Box	
Code	FG07402-*	FG07502-*	FG07602-*	FG07702-*	RW-OCL-01
Lamp Holder	1.5W LED	1.5W LED	3.5W LED	3.5W LED	E27 Max. 60W
Lumens	42lm	55lm	136lm	125lm	N/A
IP Rating	IP65	IP65	IP65	IP65	IP44
Size (mm)	80 x 80 x 61	123 x 53 x 61	135 x 135 x 65	205 x 95 x 65	233 x 101 x 83
Material	ST304 + & Aluminium				Die Cast Aluminium

*Add colour to code: ○ CW (Cool White), ○ WW (Warm White)

Supply Voltage: 12VAC/DC

Surface Mount

<td> </td>				
Code	HLH02801-*	HLH02802-*	HLH02804-*	WL11001-*
LEDs	4 x 0.1W (0.4W)	8 x 0.1W (0.8W)	12 x 0.09W (1W)	4 x 0.02 (0.8W)
Lumen	12lm	24lm	36lm	8lm
IP Rating	IP67	IP67	IP67	IP20
Size (mm)	Ø70 x 13	Ø70 x 13	Ø70 x 13	Ø45 x 15

*Add colour to code: ○ CW (Cool White), ○ WW (Warm White), ● BL (Blue)

Outdoor

LIGHTING

NEW LED PLASTIC FOOT LIGHTS IP65

Input Voltage: 230VDC | Material: ASB + PC | CCT Adjustable: 3000, 4000, 6000k

Code	P-2301-BK-CCT	P-2302-BK-CCT	P-1251-H-BK-CCT	P-1252-BK-CCT	P-1001-BK-CCT	P-2202-A-BK-CCT
LED's	4W	3W	4W	1.5W	1.5W	6W
Lumens	280lm	190lm	270lm	60lm	80lm	300lm
Size (mm)	230 x 80 x 27	230 x 80 x 27	125 x 125 x 37	125 x 125 x 37	100 x 60 x 33	220 x 113 x 51
Colour	Black	Black	Black	Black	Black	Black
Material	ABS Body / PC Diffuser	ABS Body / PC Diffuser	ABS Body / PC Diffuser	ABS Body / PC Diffuser	ABS Body / PC Diffuser	ABS Body / PC Diffuser

2-year warranty on all LED products & 1-year warranty on battery-operated products, unless specified. LED warranty void without surge protection. Refer to page 128.

LED PAVING BRICK LIGHTS IP67

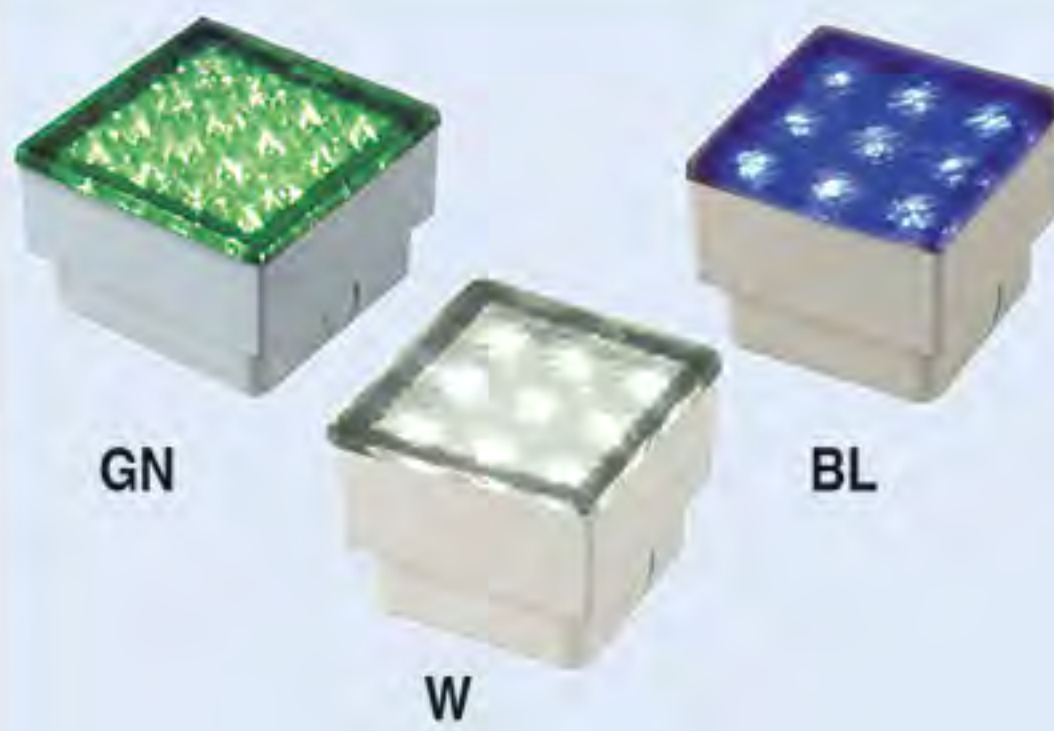

LED Paving Brick Lights

Code	Wattage	No of LED's	Size (mm)
LED-Q02* [†]	1.5W	9	80(H) x 80(L) x 68(W)

*Add colour to code: ○ W (White) ● R (Red), ● GN (Green), ● BL (Blue), ● Y (Yellow),

●●● RGB (auto colour changing)

† Add voltage to code: 230VAC, 24VAC

LED PAVING BRICK LIGHTS IP67

Supply Voltage: 230VAC



Code	CIE-L004-*	CIE-L010-*	CIE-L015-*	CIE-L016-*
LED's	12 x 0.08W (1W)	16 x 0.06W (0.96W)	18 x 0.06W (1.08W)	18 x 0.06W (1.08W)
Lumen	11lm	11lm	11lm	25lm
IP Rating	IP44	IP23	IP44	IP54
Size (mm)	190 x 250 x 105	156 x 180 x 130	Ø144 x 40	Ø145 x 40
Material	Stainless Steel	Stainless Steel	Stainless Steel	Stainless Steel

*Add LED colour to code: ○ WH (White), ● BL (Blue), ● Y (Yellow), ● GN (Green), ● R (Red)

*Add LED colour to code: ○ WH (White), ● BL (Blue), ● Y (Yellow), ● GN (Green), ● R (Red)

Supply Voltage: 230VAC



Cool White only



Cool White only



Cool White only

Code	KH252	KH252-A	KH252-C
LED's	36 x 0.12W (4.32W)	36 x 0.12W (4.32W)	36 x 0.12W (4.32W)
Lumen	144lm	144lm	144lm
IP Rating	IP44	IP44	IP44
Size (mm)	Ø140 x 55	Ø140 x 55	Ø140 x 55
Material	Stainless Steel	Stainless Steel	Stainless Steel

Supply Voltage: 230VAC



Code	LED-9006*	LED-9003*	LED-9004*
LED's	36 x 0.08W (2.9W)	36 x 0.08W (2.9W)	36 x 0.08W (2.9W)
Lumen	70lm	70lm	108lm
IP Rating	IP54	IP54	IP44
Size (mm)	Ø140 x 52	Ø140 x 52	Ø140 x 52
Material	Aluminium	Aluminium	Aluminium

*Add colour to code: ○ CW (Cool White), ● R (Red), ● GN (Green), ● BL (Blue), ● Y (Yellow)

2-year warranty on all LED products & 1-year warranty on battery-operated products, unless specified. LED warranty void without surge protection. Refer to page 128.

NEW

LED ABS & PC BULKHEADS IP54

Input Voltage: 230VAC | 90 Lumens p/W | Body Material: ABS | Diffuser: Glass

Input Voltage: 230VAC | 90 Lumens p/W | Body Material: ABS | Diffuser: PC

	<p>6000K</p>	<p>6000K</p>		
	Code BL1113-9W-* Wattage 9W Lumen 720lm Size (mm) Ø185 *Colour White / Black	Code BL1112-9W-* Wattage 9W Lumen 720lm Size (mm) Ø185 *Colour White / Black	Code LED-BL1A-C-7W-* Wattage 7W Lumen 630lm Size (mm) Ø170 x 55 *Colour White	Code LED-BL1A-C-10W-* Wattage 10W Lumen 900lm Size (mm) Ø211 x 55 *Colour White
	<p>6000K</p>	<p>6000K</p>		
	Code BL1118-9W-* Wattage 9W Lumens 720lm Size (mm) 200 x 120 *Colour White / Black	Code BL1117-9W-* Wattage 9W Lumens 720lm Size (mm) 200 x 120 *Colour White / Black	Code LED-BL1A-O-7W-* Wattage 7W Lumen 630lm Size (mm) 200 x 100 x 55 *Colour White	Code LED-BL1A-O-10W-* Wattage 10W Lumen 900lm Size (mm) 230 x 105 x 55 *Colour White

*Add body colour to code: **WH** (White), **BK** (Black) *Add colour to code: ○ **CW** (Cool White) 4000K, ○ **WW** (Warm White) 3000K

LED PLASTIC BULKHEADS IP65

<p>Clear Prismatic</p>	<p>Opal</p>	<p>Opal</p>
Code CBH-12W-* Power 12W Size (mm) Ø270 x 60 Material Plastic	Code OBH-1-12W-* Power 12W Size (mm) Ø270 x 60 Material Plastic	Code OBH-2-12W-* Power 12W Size (mm) Ø270 x 115 Material Plastic

* Add Colour to code: ○ **CW** (Cool White) 4000K, ○ **DL** (Day Light) 6000K. For Day-Night Sensor add /DN to code

○ CW - 4000K ○ DL - 6000K Supply Voltage: 85-265VAC Material: Plastic IP54				
Code LAM12T Power 12W Lumen 800lm Size (mm) 290 x 290 x 100 Colour Black Colour Temp DL	Code LAL010 Power 12W Lumen 800lm Size (mm) Ø300 x 100 Colour Black Colour Temp DL	Code LAL020 - * Power 18W Lumen 1600lm Size (mm) Ø335 x 118 Colour Black * Add Colour to code: CW / DL	Code LAL030 Power 22W Lumen 2400lm Size (mm) Ø400 x 135 Colour Black Colour Temp DL	
○ CW - 4000K ○ DL - 6000K Supply Voltage: 85-265VAC Material: Plastic IP54				
Code LAL10E Power 10W Lumen 550lm Size (mm) 290 x 200 x 100 Colour Black Colour Temp DL	Code LAL06E Power 6W Lumen 270lm Size (mm) 290 x 200 x 100 Colour Black Colour Temp DL	Code LAL07E Power 7W Lumen 260lm Size (mm) 290 x 200 x 100 Colour Black Colour Temp DL		



Outdoor

LIGHTING

LED PLASTIC BULKHEADS

Supply Voltage: 220-240VAC | Material: Plastic

 Optional	Available in Black and White		 Day/night sensor non-adjustable, ambient <25lux  PIR		
					
Code Standard	BL220-12W-*	BL220-12W-PIR-*		BL270-20W-*	BL320-24W-*
Code Day/Night	BL220-12W-*--DN	-		-	-
Wattage	12W	12W		20W	24W
Lumens	840lm	840lm		1500lm	1800lm
IP Rating	IP54	IP54		IP65	IP65
Size (mm)	Ø220 x 99	Ø220 x 99		Ø270 X 102	Ø320 x 113
Colour	White / Black	White / Black		White	White





 Optional	 3CCT ADJUSTABLE  PIR	 3CCT ADJUSTABLE  PIR				
						
Code Standard	BLO220-15W-PIR-*--CCT	BL220-20W-PIR-*--CCT	LG09A-300-17-*	CL280-CP02-18W-*	CL330-CP02-24W-*	CL280-SP02-18W-*
Code Day/Night	-	-	LG09A-300-17-*--DN	CL280-CP02-18W-*--DN	-	-
Wattage	15W	20W	17W	18W	24W	18W
Lumen	1350lm	1800lm	1300lm	1440lm	1920lm	1440lm
IP Rating	IP65	IP65	IP54	IP44	IP44	IP44
Size (mm)	220 x 106 x 60	Ø220 x 80	Ø305 x 84	Ø280 x 60	Ø330 x 60	280 x 280 x 60
Colour	White/Black	White/Black	White	White	White	White

*Add colour to code: ○ CW (Cool White) 4000K, ○ DL (Day Light) 6000K *Add trim colour to code: ● BK (Black), ○ WH (White)

RECTANGULAR BULKHEADS

Lamps excluded. For Lamps see page 7					
	Code	BH-01	NB2047-B	BK6001	BK6003
Lamp/Watts	B22/60W	E27/100W	E27	E27	E27
IP Rating	IP44	IP54	IP54	IP54	IP65
Size (mm)	220 x 105 x 105	245 x 120 x 115	250 x 175 x 116	280 x 175 x 133	330 x 230 x 190
Material	Plastic	Die-cast Al / Plastic	Plastic	Aluminium / Plastic	Aluminium / Glass

PLASTIC BULKHEAD IP54

Lamps Excluded	Plastic Opal 	Clear Diffused Plastic 	Plastic Opal 	Clear Plastic 	
	Code	WH1039-*	WH1040-*	BK1039-2D	BK1040-2D
Size (mm)	270Ø x 70		270Ø x 70		270 x 155 x 110
Lamp	*Add type of lamp to code: 2D (2D16W), 2PL9 (2 x 9PL), E27 (E27 lamp holder), 2D-MS (with microwave motion sensor), 2PL9-MS (with microwave motion sensor built into the fitting). These very sensitive sensors work on the same principle as radar.		• Black only available in 2D lamp 2D-16-4P		E27(CFL/LED)

Note: All fittings on this page that use 2D lamps use the 4-pin lamp, eg. 2D-16-4P-CW

LED OUTDOOR BULKHEADS IP65

Supply Volts:
85-265VAC

NEW



* WH / BK

Code	BH-01-CCT-P	BH-01T-CCT-P	02CL-CX-24W-*
Power	9-14-18W Adj.	9-14-18W Adj.	16-20-24W Adj.
Lumen	100lm/W	100lm/W	90lm/W
Size (mm)	Ø320 x 100	Ø320 x 75	Ø300 x 60
Material	PC Cover & ABS Base	PC Cover & ABS Base	PC Cover & ABS Base

Supply Volts:
85-265VAC
Colour Temp:
6000K

Supply Voltage:
230VAC



Code	CL3808-LED	XDF32185-15W	XDY32185-15W	XDY339125-13W
Power	15W	15W	15W	13W
Lumen	1300lm	1200lm	1200lm	1200lm
Size (mm)	Ø325 x 100	250 x 250 x 90	Ø350 x 85	300 x 100 x 85
Material	PC Cover & ABS Base	PC Cover & ABS Base	PC Cover & ABS Base	PC Cover & ABS Base

PLASTIC BULKHEADS

Lamps
excluded



Code	CL3873	CL3869	CL3819	CL3870	CL3808B
Lamp	2D-28-4P	2D-28-4P	2D-28-4P	2D-28-4P	2D-28-4P
Size (mm)	Ø316 x 125H	Ø280 x 86H	280 x 280 x 87	Ø330 x 99	Ø325 x 100
Material	PC cover ABS base IP65				

Lamps
Excluded



Chrome Trim



Gold Trim



Code	CL2153	CL10021-CH	CL10021-G	CL10022
Lamp	2D-16-4P	2D-16-4P	2D-16-4P	2D-28-4P
Size (mm)	Ø257 x 73	Ø270 x 90	Ø270 x 90	Ø320 x 90
Material	PC cover ABS base IP54			

Lamps
Excluded



Code	CL10001	CL10002	CL10003	CL10010	CL10018-1
Lamp	2 x PLCE-18	2D-28-4P	2D-28-4P	2D-16-4P	2D-28-4P
Size (mm)	340Ø x 115H	300Ø x 102H	302L x 302W x 93H	305Ø x 68H	305Ø x 80H
Material	PC cover ABS base IP54				

Outdoor

LIGHTING

LED DIE-CAST ALUMINIUM BULKHEADS IP54

Input Voltage: 220-240VAC | Body Material: Die-cast Aluminium | Diffuser: Glass | Colour Temp: 6000K | Driver on board (DOB)

Code White	BL1112-6W-WH	BL1112-12W-WH	BL1113-6W-WH	BL1113-12W-WH
Code Black	BL1112-6W-BK	BL1112-12W-BK	BL1113-6W-BK	BL1113-12W-BK
Wattage	6W	12W	6W	12W
Lumens	420lm	840lm	420lm	840lm
Size (mm)	Ø192	Ø240	Ø192	Ø240
Code White	BL1115-6W-WH	BL1115-12W-WH	BL1117-6W-WH	BL1117-12W-WH
Code Black	BL1115-6W-BK	BL1115-12W-BK	BL1117-6W-BK	BL1117-12W-BK
Wattage	6W	12W	6W	12W
Lumens	420lm	840lm	420lm	840lm
Size (mm)	Ø192	Ø240	213 x 95 x 107	283 x 162 x 140
Code White	BL1118-6W-WH	BL1118-12W-WH	BL1119-6W-WH	BL1119-12W-WH
Code Black	BL1118-6W-BK	BL1118-12W-BK	BL1119-6W-BK	BL1119-12W-BK
Wattage	6W	12W	6W	12W
Lumens	420lm	840lm	420lm	840lm
Size (mm)	213 x 95 x 107	283 x 162 x 140	213 x 95 x 107	283 x 162 x 140

BULKHEADS - INDOORS & OUTDOORS IP54

Outdoor	Lamp Type: E27. Lamps Excluded						
	Code (White)	NB304001	NB304003	NB1004L-E27	NB304004		
	Code (Black)	NB304001-B	NB304003-B	NB1004L-E27-B			
	Code G24D	NB2026 (2x13W)	NB2024 (2x13W)	NB1004L-G24 (2x13W)	NB2025 (1x13W)		
	Lamp Size (mm) Material	PLC-13 240Ø x 110 Die-Cast Aluminium	PLCE-13 240Ø x 105 Die-Cast Aluminium	PLC-13 240Ø x 128 Die-Cast Aluminium	PLCE-13 240Ø x 125 Die-Cast Aluminium		
LIGHTING	Lamp Type: E27. Lamps Excluded						
	Code (White)	NB304005-W	NB304007	NB1014L-E27	-	-	-
	Code (Black)	NB304005-B	-	-	NB2044	NB2016-S	NB2019-S
	Code G24D	NB2031 (1x13W)	NB2030 (1x13W)	NB1014-G24 (1x13W)	-	-	-
	Power	1 x 13W	1 x 13W	1 x 13W	1 x 13W	1 x 13W	1 x 13W
	Lamp	PLCE-13	PLC-13	PLC-13	PLCE-13	PLCE-13	PLCE-13
	Size (mm) Material	285 x 160 x 130 Die-Cast Aluminium	285 x 160 x 125 Die-Cast Aluminium	212 x 95 x 107 Die-Cast Aluminium	282 x 182 x 110 Die-Cast Aluminium	210 x 145 x 100 Die-Cast Aluminium	210 x 145 x 100 Die-Cast Aluminium

2-year warranty on all LED products & 1-year warranty on battery-operated products, unless specified.
LED warranty void without surge protection. Refer to page 128.

BULKHEADS - INDOORS & OUTDOORS IP54

Lamps Excluded				
Code (White)	NB2033	NB2040A	-	NB44-227-WH
Code (Black)	NB2033-BK	NB2040A-BK	NB2035	NB44-227-BK
Power	1 x 13W	1 x 13W	1 x 13W	2 x 14W Max.
Lamp	PLC-13	PLC-13	PLC-13	2 x E27
Size (mm)	Ø235 x 120	Ø270 x 90	Ø235 x 120	Ø280
Material	Die-Cast Aluminium	Die-Cast Aluminium	Die-Cast Aluminium	Die-Cast Aluminium
Lamps excluded				
Code	MAT-2-ES-C*	MAT-2-ES-O*	MAT-3-ES-O*	
Power	1 x 60W (Max.)	1 x 60W (Max.)	1 x 60W (Max.)	
Lamp Holder	E27	E27	E27	
Size (mm)	Ø270 x 60	Ø270 x 60	Ø270 x 115	
Material	Plastic	Plastic	Plastic	

* For Day-Night Sensor add **DN** to code

E27 DECORATIVE BULKHEADS IP54

Lamps excluded				
Code	NS-1851	NS-1852	NS-1853	NS-1854
Power	60W Max.	60W Max.	60W Max.	60W Max.
Lamp Holder	2 x E27	2 x E27	2 x E27	2 x E27
Size (mm)	300 x 350 x 120	300 x 350 x 120	300 x 350 x 120	300 x 350 x 120
Material	Die-Cast Aluminium	Die-Cast Aluminium	Die-Cast Aluminium	Die-Cast Aluminium
Lamps excluded				
Code	NS-1855	NS-1928A	NS-1928B	
Power	60W Max.	60W Max.	60W Max.	
Lamp Holder	2 x E27	1 x E27	1 x E27	
Size (mm)	300 x 350 x 120	247 x 252 x 110	247 x 252 x 110	
Material	Die-Cast Aluminium	Die-Cast Aluminium	Die-Cast Aluminium	
Lamps excluded				
Code	C300-006	KH554	KH553	
Power	60W/CFL	60W Max	100W max	
Lamp Holder	E27	E27	E27	
IP Rating	IP54	IP54	IP54	
Size (mm)	Ø270 x 100	Ø190 x 100	Ø250 x 100	
Material	Stainless Steel / Glass	Stainless Steel / Glass	Stainless Steel / Glass	

Outdoor

LIGHTING

LED DECORATIVE BULKHEADS IP54

Input Voltage: 95-240VAC | 90 Lumens p/w | Body Material: Die-cast Aluminium | Diffuser: PC | Colour Temp: 6000K

Code	LB-1927A	LB-1927B	LB-1927C	LB-1927D			
Wattage	10W	10W	10W	10W			
Size (mm)	290 x 180 x 90	290 x 180 x 90	290 x 180 x 90	290 x 180 x 90			
Code	LB-1932A	LB-1932B	LB-1932C	LB-1932D			
Wattage	20W	20W	20W	20W			
Size (mm)	Ø280 x 95	Ø280 x 95	Ø280 x 95	Ø280 x 95			
Code	LB-1801L	LB-1802L	LB-1803L	LB-1804L			
Wattage	20W	20W	20W	20W			
Size (mm)	270 x 270 x 80	270 x 270 x 80	270 x 270 x 80	270 x 270 x 80			
Code	LB-1802LB	LB-1803LB	LB-1804LB	LB-1842	LB-1844	LB-1841-*	LB-1843-*
Wattage	20W	20W	20W	20W	20W	20W	20W
Size (mm)	270 x 270 x 135	270 x 270 x 135	270 x 270 x 135	Ø300 x 100	300 x 300 x 100	Ø300 x 100	300 x 300 x 100
						* Add DALI to Code	

Outdoor

WALL LIGHTS IP44

Input Voltage: 230VAC

LED

LED

LED

LED

LED

Code	TL-S-TY02A	TL-S-TY02B	TL-S-TY02C	TL-S-TY02D	TL-S-TY02E
Wattage	7W	7W	7W	7W	7W
Lumens	350lm	350lm	350lm	350lm	350lm
Size (mm)	194 x 232 x 162	194 x 232 x 162	Ø162 x 280	Ø162 x 825	Ø162 x 1100

LIGHTING

2-year warranty on all LED products & 1-year warranty on battery-operated products, unless specified.
LED warranty void without surge protection. Refer to page 128.

OUTDOOR WALL LIGHTS

SOLAR SOL2

- 6-8 Hrs Normal Brightness
- Alu. Body & Glass Lamp
- Auto Turn On/Off Dusk/Dawn

Solar Wall Light IP44

Solar Pillar Light IP44

Auto on/off
PMMA Shade

Code	JY-0012-A	JY-0007-A	JY-0008-A	JY-0012-B	JY-0007-B	JY-0008-B	GD-B-250-S1-S
Wattage	2.4W	3W	4W	2.4W	3W	4W	1.5W
Lumens	220lm	130lm	220lm	130lm	220lm	220lm	150lm
Size	Ø220 x 530	Ø260 x 400	Ø280 x 360	Ø220 x 550	Ø260 x 430	Ø280 x 390	Ø250x321

Supply Voltage: 230VAC	Green/Black	Black	c/w Chain	Timer: 6s - 12m Sensor: 12m	Timer: 6s - 12m Sensor: 10m/180°	Timer: 6s - 12m Sensor: 10m/180°	Supply Voltage: 230VAC Glass Diffuser Lamps Excluded	
Lamps Excluded								

Code	F3225-B/G	F3225	LH-5004H	F3125	F4025	F4034	F4034-2	TL-W-03A
Power	60W	60W	100W	60W	60W	1 x 150W	2 x 150W	60W Max.
Lamp Holder	E27	E27	E27	E27	E27	E27	E27	E27
IP Rating	IP33	IP44	IP33	IP44	IP33	IP33	IP33	IP54
Size (mm)	405 x 203	442 x 195	1025 x 225	346H x 176W	406H x 232W	115 x 160 x 115	270 x 220 x 115	250 x 260 x 420
Material	Die-Cast Aluminium	Die-Cast Aluminium	Die-Cast Aluminium	Die-Cast Aluminium	Die-Cast Aluminium	Die-Cast Aluminium	Die-Cast Aluminium	Stainless Steel

Supply Voltage: 230VAC				Green/Black	Black																																																		
Lamps Excluded							<table border="1"> <tr> <td>Code</td> <td>SS-13014</td> <td>LH-5029H</td> <td>LH-5029D</td> <td>F3025-B/G</td> <td>F3025</td> <td>LH-5004D</td> <td>NY1022-*</td> </tr> <tr> <td>Power</td> <td>75W</td> <td>100W</td> <td>60W</td> <td>60W</td> <td>60W</td> <td>100W</td> <td>100W</td> </tr> <tr> <td>Lamp Holder</td> <td>E27</td> <td>E27</td> <td>E27</td> <td>E27</td> <td>E27</td> <td>E27</td> <td>E27</td> </tr> <tr> <td>IP Rating</td> <td>IP33</td> <td>IP44</td> <td>IP33</td> <td>IP33</td> <td>IP44</td> <td>IP33</td> <td>IP33</td> </tr> <tr> <td>Size (mm)</td> <td>250D x 235H</td> <td>875 x 245</td> <td>475 x 395</td> <td>346 x 176</td> <td>346 x 176</td> <td>410 x 260</td> <td>212 x 336</td> </tr> <tr> <td>Material</td> <td>Die-Cast Aluminium</td> <td>Die-Cast Aluminium</td> <td>Die-Cast Aluminium</td> <td>Die-Cast Aluminium</td> <td>Die-Cast Aluminium</td> <td>Die-Cast Aluminium</td> <td>Die-Cast Aluminium</td> </tr> </table>	Code	SS-13014	LH-5029H	LH-5029D	F3025-B/G	F3025	LH-5004D	NY1022-*	Power	75W	100W	60W	60W	60W	100W	100W	Lamp Holder	E27	E27	E27	E27	E27	E27	E27	IP Rating	IP33	IP44	IP33	IP33	IP44	IP33	IP33	Size (mm)	250D x 235H	875 x 245	475 x 395	346 x 176	346 x 176	410 x 260	212 x 336	Material	Die-Cast Aluminium	Die-Cast Aluminium	Die-Cast Aluminium	Die-Cast Aluminium	Die-Cast Aluminium	Die-Cast Aluminium	Die-Cast Aluminium
Code	SS-13014	LH-5029H	LH-5029D	F3025-B/G	F3025	LH-5004D	NY1022-*																																																
Power	75W	100W	60W	60W	60W	100W	100W																																																
Lamp Holder	E27	E27	E27	E27	E27	E27	E27																																																
IP Rating	IP33	IP44	IP33	IP33	IP44	IP33	IP33																																																
Size (mm)	250D x 235H	875 x 245	475 x 395	346 x 176	346 x 176	410 x 260	212 x 336																																																
Material	Die-Cast Aluminium	Die-Cast Aluminium	Die-Cast Aluminium	Die-Cast Aluminium	Die-Cast Aluminium	Die-Cast Aluminium	Die-Cast Aluminium																																																

Supply Voltage: 230VAC						Timer: 20s-8min Sensor: 12m Plastic	c/w built-in daylight switch
Lamps Excluded							

Code	NY1592B	NY1001L-*/	YF-B5359	YF-B5352	YF-B5319	F4018	JQ703
Power	100W	100W	60W	60W	60W	100W	26W
Lamp Holder	E27	E27	E27	E27	E27	E27	E27
IP Rating	IP33	IP33	IP33	IP33	IP33	IP33	IP33
Size (mm)	245 x 310	285 x 470	350 x 165	285 x 155	Ø230	210 x 260	Ø230
Material	Die-Cast Aluminium	Die-Cast Aluminium	Die-Cast Aluminium	Die-Cast Aluminium	Die-Cast Aluminium	Die-Cast Aluminium	Die-Cast Aluminium

*Add colour of fitting to code: **GR** (Grey), **BK** (Black) *Add colour of fitting to code: **GR** (Grey), **B/G** (Black and Green)

2-year warranty on all LED products & 1-year warranty on battery-operated products, unless specified. LED warranty void without surge protection. Refer to page 128.

PMMA LAMP SHADES BAYONET NECK

Lamp shades c/w galleries. Not to be used with Screw-in galleries



Code 8"	GD01-B-200-O	GD01-B-200-CL	GD01-B-200-SY	GD01-B-200-CP
Code 10"	GD01-B-250-O	GD01-B-250-CL	GD01-B-250-SY	GD01-B-250-CP
Colour	Opal	Clear	Smoky	Clear Prismatic



Code	GD011-O	GD011-CL	GD011-GD	GD012-CL	GD012-GD	GD012-CP
Colour	Opal	Clear	Gold	Clear	Gold	Clear Prismatic

ACCESSORIES FOR BAYONET NECK

Application



Short Stand / Long Stand

Code	Description	Material	Dimensions (mm)
GDB-PL-*	Pole	PVC	Ø60 x 0.5m / 1m / 1.5m / 1.8m
GDB-PB170	Pole Base	ABS	Ø160 x 170

*Add length to code: 0.5M, 1M, 1.5M, 1.8M

Application



Short / Long Stand

Code	A (mm)	B (mm)	For Sphere with Bayonet Neck (mm)
GDB-SS-120	120	Ø60	Maximum Ø200
GDB-LS-160	160	Ø60	Maximum Ø250

Application

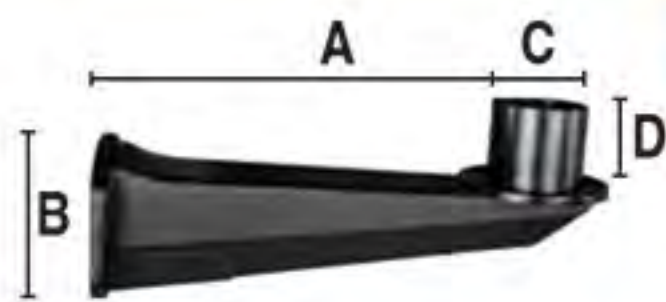

Short / Long Arm Wall Mount

Code	A (mm)	B (mm)	C (mm)	D (mm)	For Sphere with Bayonet Neck (mm)
GDB-SA-190	190	100	60	32	Maximum Ø250
GDB-LA-310	310	100	60	47	Maximum Ø250

Application



Single / Double Elbow Wall Mount

Code	A (mm)	B (mm)	C (mm)	D (mm)	For Sphere with Bayonet Neck (mm)
GDB-S	270	270	125	/	Maximum Ø250

Application



Basket

Code	A (mm)	B (mm)	C (mm)	For Sphere with Bayonet Neck (mm)
GDB-B122	122	290	160	Ø250

Application



Reflector

Code	A (mm)	B (mm)	C (mm)	D (mm)	Flats	Material	For Sphere with Bayonet Neck (mm)
GDB-R168	168	48	85	50	3	Iron	Maximum Ø200
GDB-R190	190	69	103	68	4	Iron	Maximum Ø250

Outdoor

LIGHTING

OUTDOOR WALL LIGHTS

Supply Voltage: 230VAC LED			
Lamps Excluded		Clear	Red
Code	RW-360D-*	X1000C (Clear)	X1000R (Red)
Power	9W (900lm)	25W	25W
Lamp Holder	LED	G9	G9
IP Rating	IP65	IP55	IP55
Size (mm)	110 x 120 x 45	Ø90 x 85	Ø90 x 85

*Add colour to code: ○ CW (Cool White - 4000K), ○ WW (Warm White - 2700K)

Lamps excluded						
	E27	E27	E27	4200K	4200K	
Code	YSC-2002	YSC-2004	YSC-2003	KH820-ADN	KH820-CDN	KH836WU-STONE
Wattage	60W Max	60W Max	60W Max	16 x 0.12W (1.92W)	16 x 0.12W (1.92W)	24 x 0.12W (2.88W)
Lumen	-	-	-	51.2lm	51.2lm	76.8lm
IP Rating	IP44	IP44	IP44	IP44	IP44	IP44
Size (mm)	230 x 260 x 90	230 x 260 x 90	230 x 260 x 90	112 x 90	139 x 90	Ø76 x 220
Material	Die Cast Aluminium	Die Cast Aluminium	Die Cast Aluminium	Stainless Steel	Stainless Steel	Stainless Steel
Colour	Black	Grey	Oxidized	Silver	Silver	White Stone

Supply Voltage: 230VAC LED				
○ CW - 4200K				
Code	TL-ST-05B	TL-ST-06B	TL-ST-05A	TL-ST-06A
Wattage	6W	2 x 6W	6W	2 x 6W
Lumen	300lm	550lm	300lm	550lm
IP Rating	IP44	IP44	IP44	IP44
Size (mm)	Ø76 x 220 x 115	Ø76 x 200 x 115	Ø76 x 280	Ø76 x 340
Material	Stainless Steel	Stainless Steel	Stainless Steel	Stainless Steel
Colour Temp	Cool White	Cool White	Cool White	Cool White

Supply Voltage: 230VAC Colour Temp.: 4000K Dark Grey						
					GU10	E27
Code	YSC-2034	YSC-2013	YSC-2011	YSC-2017	LD3001-56	NY1836
Wattage	5W	5W	5W	5W	50W	100W
Lumen	500lm	500lm	500lm	500lm	-	-
IP Rating	IP54	IP54	IP54	IP54	IP44	IP54
Size (mm)	76 x 106 x 65	50 x 120 x 180	60 x 242 x 122	100 x 195 x 164	150 x 380	84 x 240
Material	Die Cast Aluminium	Die Cast Aluminium	Die Cast Aluminium	Die Cast Aluminium	Die Cast Aluminium	Die Cast Aluminium

NEW						
					4000K	4000K
Code	LBD-2360-A-12*	LBD-2360-B-12*	LBD-2460-A-12*	LBD-2460-B-12*	B2365	B2366
Wattage	12W	12W	12W	12W	2 x 5W	2 x 5W
Lumens	1200lm	1200lm	1200lm	1200lm	2 x 500lm	2 x 500lm
IP Rating	IP54	IP54	IP54	IP54	IP54	IP54
Size	Ø170 x 100	Ø170 x 100	160 x 160 x 100	160 x 160 x 100	Ø97 x 134	97 x 97 x 134
Material	Die-Cast Aluminium / PC					

*Add colour to code: ○ CW (Clear White), ○ WW (Warm White)

2-year warranty on all LED products & 1-year warranty on battery-operated products, unless specified. LED warranty void without surge protection. Refer to page 128.

OUTDOOR WALL LIGHTS

Supply Voltage: 230VAC Lamps Excluded S/Steel + PS						
Code	HC-26402	HC26902	HC-27302	HC-24401	HC-24801	HC-23301
Power	10W	20W	Max 20W	Max 20W	Max 20W	Max 20W
Lamp Holder	E14	E27	E27	E27	E27	E27
IP Rating	IP54	IP54	IP54	IP54	IP54	IP54
Size (mm)	130 x 240 x 170	130 x 240 x 170	224 x 240 x 176	170 x 220 x 210	220 x 285 x 270	250 x 320 x 220
Supply Voltage: 230VAC Lamps Excluded	Die-Cast Aluminium Black 	Die-Cast Aluminium Black 	With day/night sensor 			
Code	AB-1001-BK	AB-2002-BK	CIE008S	CIE018	CIE053-G-*	
Power	10W LED Max.	2 x 10W LED Max.	60W/CFL	60W/CFL	2 x 25W	
Lamp Holder	E27	2 x E27	E27	E27	G9 / E27	
IP Rating	IP33	IP33	IP44	IP44	IP44	
Size (mm)	158 x 250 x 110	95 x 355 x 100	Ø60 x 430	Ø76 x 390	Ø63 x 250	
Supply Voltage: 230VAC Lamps Excluded						With day/night sensor 
Code	CIE019	CIE015	C300-008	CIE013-A	C300-223	CIE007S
Power	60W/CFL	60W/CFL	60W/CFL	60W/CFL	100W/CFL	60W/CFL
Lamp Holder	E27	E27	E27	E27	E27	E27
IP Rating	IP44	IP44	IP44	IP44	IP44	IP44
Size (mm)	Ø120 x 390	Ø120 x 395	260 x 220 x 90	250 x 300	Ø250 x 380 x 410	Ø200 x 250 x 345
Supply Voltage: 230VAC Lamps Excluded						S/Steel body & glass diffuser 
Code	KH147-WU	KH148WU+SEN	KH148WU	C300-110	C300-203	KH177AWU
Power	50W max	50W max	50W	60W/CFL	60W/CFL	60W/ CFL
Lamp Holder	GU10	GU10	GU10	E27	E27	E27
IP Rating	IP44	IP44	IP44	IP44	IP44	IP44
Size (mm)	195 x 240	200 x 260	200 x 225	260 x 235	225 x 276	Ø128 x 480
Supply Voltage: 230VAC Lamps Excluded S/Steel & Alum body with PC diffuser						
Code	KH715-BK	KH715	KH715WU-BK	KH715WU	KH246E	
Power	60W	60W	60W	60W	60W	
Lamp Holder	E27	E27	E27	E27	E27	
IP Rating	IP44	IP44	IP44	IP44	IP44	
Size (mm)	235 x 445	235 x 445	175 x 345	175 x 345	345 x 100	

*Add Lamp Holder Type to code: G9, E27

Outdoor

LIGHTING

UP / DOWN LIGHTS

Supply Voltage: 230VAC *Add colour to code: ○ WW - 2700K ○ CW - 4200K						
Code	B2344*	B2344-1*	B2344-2*	B2282*	B2283*	B2284*
Wattage	2 x 10W	2 x 10W	2 x 10W	2 x 10W	2 x 10W	2 x 10W
Lumen	2000lm	2000lm	2000lm	2000lm	2000lm	2000lm
IP Rating	IP54	IP54	IP54	IP54	IP54	IP54
Size (mm)	179 x 90 x 102	179 x 90 x 102	179 x 90 x 102	200 x 93 x 93	200 x 93 x 93	200 x 93 x 93
Material	Aluminium & Glass	Aluminium & Glass	Aluminium & Glass	Aluminium & Glass	Aluminium & Glass	Aluminium & Glass
Colour Temp	*WW / CW	*WW / CW	*WW / CW	*WW / CW	*WW / CW	*WW / CW

Supply Voltage: 230VAC					
Code	K-W12-CW	HLH00102*	FH14901*	FH15001*	Y-LED-3202-2 BK
Wattage	2 x 15W	2 x 20W	10W	2 x 10W	2 x 6.5W
Lumens	3000lm	4000lm	700lm	1400lm	700lm
IP Rating	IP65	IP54	IP54	IP54	IP54
Size	160 x 90 x 55	200 x 150 x 300	144 x 114 x 141	144 x 114 x 211	65 x 91 x 220
Material	Aluminium	Aluminium	Aluminium	Aluminium	Die-Cast Aluminium

*Add colour to code: ○ CW (Cool White), ○ WW (Warm White)

230VAC	230VAC	230VAC	12VAC	230VAC	230VAC	
Code	HLH00701*	LED-3041C-1/AL*	LED-3042C-1/AL*	LED-3042/AL*	LED-3042B-1/AL*	LED-3043-1/AL*
Wattage	2 x 6W	3 x 1W (3W)	6 x 1W (6W)	2 x 1W (2W)	2 x 1W (2W)	2 x 1W (2W)
Lumen	1200lm	90lm	2 x 90lm	2 x 30lm	2 x 30lm	2 x 30lm
IP Rating	IP54	IP44	IP44	IP44	IP44	IP44
Size (mm)	120 x 80 x 200	Ø60 x 132	Ø60 x 135	Ø30 x 68	Ø44 x 110	44Ø x 100
Material	Aluminium	Aluminium	Aluminium	Aluminium	Aluminium	Aluminium

*Add LED colour to code: ○ WH (White), ● BL (Blue), ● Y (Yellow), ● GN (Green), ● R (Red)

Supply Voltage: 230VAC Lamps Excluded				
Code	YF-B5475	DH28330	P1602-GU10	P1600-GU10
Power	2 x 60W	2 x 60W	Max 1 x 6W	Max 2 x 6W
Lamp Holder	E27	E27	GU10	2 x GU10
IP Rating	IP44	IP44	IP44	IP44
Size (mm)	90Ø x 260	118 x 181 x 400	87 x 60 x 120	87 x 60 x 158

2-year warranty on all LED products & 1-year warranty on battery-operated products, unless specified. LED warranty void without surge protection. Refer to page 128.

UP / DOWN LIGHTS

Supply Voltage: 230VAC Colour: Grey, Frosted PVC Lamps Excluded								
Code	S7901	S72603	S7903	S72204	S72403	S72201	S72404	
Power	4 x 40W	40W	4 x 40W	40W	2 x 50W	2 x 40W	2 x 50W	
Lamp Holder	E27	E27	E27	E27	G9	E27	G9	
IP Rating	IP54	IP54	IP54	IP54	IP54	IP54	IP54	
Size (mm)	Ø65 x 235	Ø90 x 190	Ø90 x 265	Ø90 x 170	Ø90 x 100	Ø110 x 300	Ø90 x 100	
Supply Voltage: 230VAC Lamps Excluded			 Narrow Beam	 Wide Beam				
Code	X2000		X1002B-N	X1002B-W	X1001D	B5300A		
Power	50W		75W		100W	25W		
Lamp Holder	G9		G9		E27	G9		
IP Rating	IP54		IP54		IP55	IP54		
Size (mm)	Ø130 x 155		150 x 80		Ø170 x 160	Ø108 x 120		
Supply Voltage: 230VAC Lamps Excluded								
Code	B2000A	B6400A	B6400B	NY6051				
Power	2 x 50W	50W	2 x 50W	50W				
Lamp Holder	GU10	GU10	GU10	GU10				
IP Rating	IP54	IP54	IP54	IP54				
Size (mm)	272 x 90 x 120	155 x 104	236 x 104	150 x 102				
Outdoor								
	IDEAL FOR COASTAL REGIONS NEW							
Code	PS1101-GU10-BK	PS1102-GU10-BK	PS0970-GU10-BK	PS1952-GU10-BK				
Power	1 x 7W Max	1 x 7W Max	1 x 7W Max	2 x 7W Max				
Lamp Holder	GU10	GU10	GU10	GU10				
IP Rating	IP54	IP54	IP54	IP54				
Size (mm)	110 x 110 x 85	110 x 110 x 85	90 x 90 x 92	110 x 195 x 85				
Material	Plastic				Plastic			
LIGHTING								
	IDEAL FOR COASTAL REGIONS NEW							
Code	PS1951-GU10-BK	PS1670-GU10-BK	PS0980-GU10-BK	PS1680-GU10-BK				
Power	2 x 7W Max	2 x 7W Max	2 x 7W Max	2 x 7W Max				
Lamp Holder	GU10	GU10	GU10	GU10				
IP Rating	IP54	IP54	IP54	IP54				
Size (mm)	110 x 195 x 85	70 x 160 x 92	70 x 90 x 92	70 x 160 x 92				
Material	Plastic				Plastic			

2-year warranty on all LED products & 1-year warranty on battery-operated products, unless specified.
LED warranty void without surge protection. Refer to page 128.

UP / DOWN LIGHTS

Lamps excluded



4200K

4200K

Code	MT2609-2W-SN	MT2609-2W-WH	LED-HALO-6-*-*	L3549-160-*	L3548-160-*
Wattage	2 x 7W	2 x 7W	6W	2 x 3W	1 x 3W
Lumens	1400lm	1400lm	310lm	480lm	240lm
IP Rating	IP20	IP20	IP20	IP20	IP20
Colour	Satin Nickle	Matt White	* W / PA / BLK	White	White
Size (mm)	Ø140 x 350	Ø140 x 350	170 x 100 x 80	160 x 70 x 90	160 x 100 x 90

*Add colour to code: ○ CW (Cool White), ○ WW (Warm White) *Add Material colour to code: ○ W (White), ○ PA (Polished Aluminium), ● BLK (Black)



Code	L35-370-*	L35-200-*	L35-100-*	L3543-160-*
Wattage	1 x 10W	1 x 5W	1 x 5W	2 x 4W
Lumens	800lm	250lm	400lm	480lm
IP Rating	IP20	IP20	IP20	IP20
Colour	White	White	White	White
Size (mm)	370 x 80 x 100	200 x 80 x 100	100 x 80 x 100	160 x 100 x 90



Code	L3544-160-*	L3541-160-*	L3542-160-*	L3536-100B-*
Wattage	2 x 3W	2 x 3W	2 x 3W	2 x 3W
Lumens	480lm	480lm	480lm	480lm
IP Rating	IP20	IP20	IP20	IP20
Colour	White	White	White	White
Size (mm)	160 x 100 x 90	160 x 100 x 90	160 x 100 x 90	100 x 100 x 100

*Add colour to code: ○ CW (Cool White), ○ WW (Warm White)

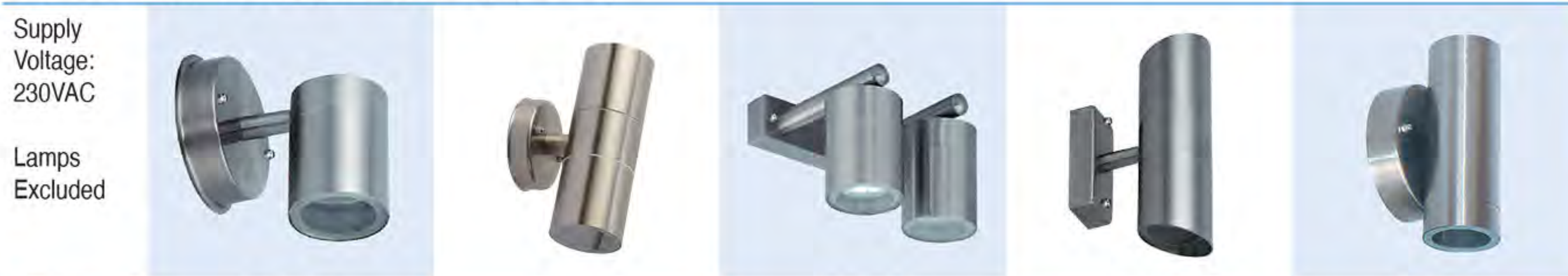

Code	CIE052-1	CIE053-1	CIE053-3	CIE053-4	CIE0030
Power	35W	2 x 35W	2 x 35W	2 x 35W	2 x 35W
Lamp Holder	GU10	GU10	GU10	GU10	GU10
IP Rating	IP44	IP44	IP44	IP44	IP44
Size (mm)	Ø60 x 113	Ø60 x 162H	Ø60 x 120	Ø60 x 205	Ø60 x 155

2-year warranty on all LED products & 1-year warranty on battery-operated products, unless specified. LED warranty void without surge protection. Refer to page 128.

INDOOR WALL LIGHTS

Supply Voltage: 230VAC

Lamps excluded

				
Code	LS0617-WW	L060A-DL	V29232-NS	KFD0919
Wattage	1.2W	3W	1 x 40W & 1 x 3W	1 X 60W Max.
Lumens	90lm	240lm	-	-
Lamp Holder	-	-	E27 & LED	E27
Colour	Satin White	White	Satin Nickle	Chrome / White
Size (mm)	Ø32 x 350	Ø250 x 35	Stainless Steel	Steel
Material	Aluminium	Aluminium	200 x 150 x 500	Ø230 x 370

					
Code	EL202724-DL	WB-100SC	RL-6326-*	RL-7328-*	LEDB025-*
Power	1W	1 x 3W	3W (210lm)	3W (210lm)	3W(100ml)
Lamp Holder	LED	LED	LED	LED	LED
Size (mm)	Ø65 x 493	160 x 110	Ø150 x 110	Ø150 x 195	Ø150 x 150
Material	Aluminium	Satin Chrome	Aluminium	Aluminium	Aluminium
Colour	Chrome	Satin Chrome		White / Black / Satin Nickle	

* Add colour to code: ○ WH (White), ● BK (Black), ○ SN (Satin Nickle)

						
Code	MB-800	FY-2316	HK-149240000	HK-149240001	Y102/1	Y102/2
Power	2 x 36W (Double Sided)	Max. 50W	2 x 40W	3 x 40W	20W	2 x 20W
Lamp Holder	LED	E14	E27	E27	G4	G4
Size (mm)	Ø220	165 x 260 x 140	300 x 90 x 250	W500 x L100 x H250	110 x 110	220 x 110
Material	Electrodeposited Chromium Chrome	Aluminium	Glass & Steel	Glass & Steel	Steel, iron & crystal	Steel, iron & crystal
Colour	Chrome	Matt Silver	White	White	Black	Black

				
Code	HF-12-1908H	HF-12-1934H	HF-12-1942H	HF-12-1952H
Lamp Holder	E27	E27	E27	E27
Material	Metal Body, Glass Cover	Metal Body, Glass Cover	Metal Body, Glass Cover	Metal Body, Glass Cover

2-year warranty on all LED products & 1-year warranty on battery-operated products, unless specified. LED warranty void without surge protection. Refer to page 128.

CEILING LIGHTS

	Opal Fittings				Clear Fittings			
Lamps excluded								
Code	NB250-P	NB280-P	NB250-PCL	NB280-PCL				
Size	6"	8"	6"	8"				
Lamp Holder	B22/PVC	B22/Porcelain	B22/PVC	B22/PVC				
Material	PVC Bowl	PVC Bowl	PVC Bowl	PVC Bowl				
Spare Bowl	NB250-P-DIF	NB280-P-DIF	NB250-PCL-DIF	-				
Glass Bowl	NB250-G	-	-	-				
	Clear Prismatic Fittings		Smoky Fittings		Opal Fitting + Lamp			
Lamps excluded					All in one 			
Code	CDS1-150-CP	CDS1-200-CP	CDS1-150-S	CDS1-200-S	NB250-5W-PW			
Size	6"	8"	6"	8"	6"			
Lamp Holder	E27	E27	E27	E27	B22 / PVC			
Material	PMMA Bowl	PMMA Bowl	PMMA Bowl	PMMA Bowl	PMMA Bowl			
	Jam Jars							
Lamps excluded					For 6" bowl		For 8" bowl	
Code	JJ60-B22	PJ60-B22	GD008-S	GD008-L	CLH22-3-C (Ceramic)	CLH22-8-C (Ceramic)	CLH22-3-N (Nylon)	CLH22-8-N (Nylon)
Lamp/Watts	B22/60W	B22/60W	E27	E27	B22 / 60W		B22 / 60W	
Material	Glass	PMMA	PMMA	PMMA	Ceramic or Nylon		Ceramic or Nylon	
Size (mm)	Ø90 x 190	Ø90 x 190	Ø85 x 170	Ø140 x 270	Ø105 x 50		Ø120 x 30H	
Lamps included								
Code	PJ60-9W-*	JJ60-9W-*	GD008-S-9W-*	GD008-L-20W-WW				
Damp/Watts	B22/9W	B22/9W	E27/9W	E27/20W				
Material	PMMA	Glass	PMMA	PMMA				
Size (mm)	Ø90 x 190	Ø90 x 190	Ø85 x 270	Ø140 x 270				
*Add colour to code: ● WW (Warm White) 3200k, ○ CW (Cool White) 4000k								
Supply Voltage: 230VAC								
Code	MX-236-15W	MX-238-8W	MX-262-400	MX-263-400				
Power	15W	8W	26W	26W				
Lumen	1300lm	600lm	2210lm	2210lm				
IP Rating	IP20	IP20	IP20	IP20				
Colour Temp	4000K	4000K	6000K	6000K				
Size (mm)	Ø400 x 65	Ø300 x 50	Ø480 x 50	460 x 460 x 50				
Material	PC base / PC diffuser	PC base / PC diffuser	PC base / PC diffuser	PC base / PC diffuser				
Supply Voltage: 230VAC	Dimmable & CCT adjustable. c/w remote							
Code	MLS-XD640D-60	LAA12-*	LAA16-*	LAA20-*	MY-380-01			
Power	60W	12W	16W	24W	18W			
Lumen	4500lm	888lm	1184lm	1480lm	1080lm			
IP Rating	IP20	IP20	IP20	IP20	IP20			
Colour Temp	2800-6700K	*○ CW (4000K) / ○ DL (6000K)	*○ CW (4000K) / ○ DL (6000K)	*○ CW (4000K) / ○ DL (6000K)	6000K			
Size (mm)	Ø646 x 94	Ø260 x 80	Ø300 x 98	Ø385 x 100	Ø380 x 100			
Material	Steel base / PC diffuser	Steel base / PC diffuser	Steel base / PC diffuser	Steel base / PC diffuser	Steel base / PC diffuser			

CEILING LIGHT FITTINGS

Supply Voltage:
230VAC



Code	MY-250-01	ASL-005	LAB16	RW6100-15C
Power	12W	20W	16W	10W
Lumen	720lm	1100lm	900lm	600lm
IP Rating	IP20	IP20	IP20	IP20
Colour Temp	6000K	6000K	6000K	6000K
Size (mm)	Ø280 x 80	Ø350 x 105	Ø330 x 75	Ø250 x 80
Material	Steel base / PC diffuser	S/S Trim / PC diffuser	PC base / PC diffuser	PC base / PC diffuser

Supply Voltage:
230VAC



Code	LAC12	LAC18	LAC22	LAD12	LAD22
Power	12W	18W	22W	12W	22W
Lumen	888lm	1350lm	1650lm / 1440lm	900lm	1650lm
IP Rating	IP20	IP20	IP20	IP20	IP20
Colour Temp	6000K	6000K	6000K	6000K	6000K
Size (mm)	Ø260 x 100	Ø330 x 100	Ø400 x 100	Ø260 x 100	Ø400 x 100
Material	Steel base / PC diffuser	Steel base / PC diffuser	Steel base / PC diffuser	Steel base / PC diffuser	Steel base / PC diffuser

Supply Voltage:
230VAC



Code	LAE12	LAE22	MY-250-06	MY-380-06	L29199-230	L29199-280
Power	12W	22W	12W	18W	12W	15W
Lumen	900lm	1650lm	660lm	990lm	1200lm	1500lm
IP Rating	IP20	IP20	IP20	IP20	IP20	IP20
Colour Temp	6000K	6000K	6000K	6000K	6000K	6000K
Size (mm)	Ø260 x 100	Ø400 x 100	Ø340 x 100	Ø380 x 105	Ø230	Ø280
Material	S/S Trim / PC diffuser	S/S Trim / PC diffuser	S/S Trim / PC diffuser	S/S Trim / PC diffuser	S/S Trim / PC diffuser	S/S Trim / PC diffuser

Indoor



Code	XCL-1728*	XCL-1738*	XCL-1743*
Power	12W	24W	36W
Lumen	900lm	1800lm	2700lm
IP Rating	IP44	IP44	IP44
*Colour Temp	CW (4200K), DL (6000K)	CW (4200K), DL (6000K)	CW (4200K), DL (6000K)
Size (mm)	Ø280 x 63	Ø380 x 63	Ø435 x 63
Material	Steel body + ABS diffuser	Steel body + ABS diffuser	Steel body + ABS diffuser
White Trim	XCL-1728-TR-WH	XCL-1738-TR-WH	XCL-1743-TR-WH
Black Trim	XCL-1728-TR-BK	XCL-1738-TR-BK	XCL-1743-TR-BK
Wood Finish Trim	XCL-1728-TR-WD	XCL-1738-TR-WD	XCL-1743-TR-WD

Input Voltage: 230VAC | Trim Rings available in White, Black or Wooden Finish | Trim Ring to be ordered Separately

Lamps excluded



Code	HF-12-1908F	HF-16-1908F	HF-12-1934F	HF-16-1934F	HF-12-1942F	HF-16-1942F	HF-12-1952F	HF-16-1952F
Lamp Holder	2 x E27	2 x E27	2 x E27	2 x E27	2 x E27	2 x E27	2 x E27	2 x E27
Size (mm)	Ø300 (12")	Ø400 (16")	Ø300 (12")	Ø400 (16")	Ø300 (12")	Ø400 (16")	Ø300 (12")	Ø400 (16")
Material	Metal Body, Glass Cover		Metal Body, Glass Cover		Metal Body, Glass Cover		Metal Body, Glass Cover	

2-year warranty on all LED products & 1-year warranty on battery-operated products, unless specified.
LED warranty void without surge protection. Refer to page 128.

CEILING LIGHTS

Lamps Excluded				
Code	HK-149280003	DL-118-C	DL-0208	DL-0211
Power	3 x 60W	1 x 60W	1 x 60W	1 x 60W
Lamp Holder	E27	E27	E27	E27
Size (mm)	400 x 400 x 85	235 x 235	190 x 190	215 x 215
Material	Glass & Steel	Clear Glass	Clear Glass	Clear Glass
Code	GCL-0508-S	GCL-0508-R	GCL-0510-S	GCL-0510-R
Power	1 x 40W	1 x 40W	1 x 40W	1 x 40W
Lamp Base	E27	E27	E27	E27
Size (mm)	200 x 200	Ø200	250 x 250	Ø250
Material	Metal Base / Glass	Metal Base / Glass	Metal Base / Glass	Metal Base / Glass
Colour	Opal	Opal	Opal	Opal

CEILING SPOT LIGHTS

Base Size: Ø80mm Lamps Excluded					
Code	KT-0004-1-SN	KT-0004-2-SN	KT-0006-2GM	KT-0004-3-SN	KT-0004-5-SN
LED Power	1 x GU10	2 x GU10	2 x GU10	3 x GU10	3 x GU10
Size (mm)	110 x 80 x 105	275 x 80 x 145	Ø150 x 100	440 x 85 x 140	250 x 230 x 145
Colour	Satin Nickle	Satin Nickle	Gun Metal	Satin Nickle	Satin Nickle
Base Size: Ø80mm Lamps Excluded					
Code	KT-6005-1-SN	KT-6005-2-SN	KT-6005-3-SN	KT-6005-5-SN	
LED Power	1 x GU10	2 x GU10	3 x GU10	3 x GU10	
Size (mm)	105 x 80 x 90	275 x 80 x 110	485 x 80 x 110	250 x 230 x 145	
Colour	SN / WH	SN / WH	SN / WH	SN / WH	

*Add fitting colour to code: **SN** (Satin Nickle) or **WH** (White)

Shade Size: Ø52 x 75mm Lamps Excluded				
Code	KT-0001-1*	KT-0001-2*	KT-0001-3*	KT-0001-4*
LED Power	1 x GU10	2 x GU10	3 x GU10	4 x GU10
Size (mm)	150 x 90 x 140	320 x 80 x 140	460 x 80 x 140	260 x 220 x 140
Colour	White/Black	White/Black	White/Black	White/Black

*Add **-BK** to code for Black

CEILING SPOT LIGHTS

Base Size: Ø80mm Lamps Excluded				
Code	KT-0006-1	KT-0006-2	KT-0006-3	KT-0006-5
LED Power	GU10	GU10	GU10	GU10
Size (mm)	80 x 135 x 115	275 x 160 x 135	385 x 160 x 135	360 x 360 x 150
Colour	Satin Nickle / Frosted Glass	Satin Nickle / Frosted Glass	Satin Nickle / Frosted Glass	Satin Nickle / Frosted Glass
Beam Angle: 30° Colour Temp: 4000K	 LED	 LED	 LED	 LED
Code	SLD07W1C-*	SLD07W2E-*	SLD07W3E-*	SLD07W3C-*
LED Power	5W	10W	16W	16W
Size (mm)	Ø90 x 90	105 x 220	105 x 360	Ø200 x 105
Colour	*Add lamp colour to code: WH (White), CH (Chrome), N (Brushed Nickel)			
Beam Angle: 30° Colour Temp: 4000K	 LED	 LED	 LED	 LED
Code	SLD08W1C-*	SLD08W2A-*	SLD08W3F-*	SLD08W3C-*
LED Power	4.1W	7W	13.5W	13.5W
Size (mm)	Ø90 x 130	150 x 225	150 x 415	Ø200 x 130
Colour	*Add lamp colour to code: CH (Chrome), N (Brushed Nickel)			
Beam Angle: 30° Colour Temp: 4000K	 LED	 LED	 LED	
Code	SLD04W1C-*	SLD04W2A-*	SLD04W3F-*	
LED Power	3.8W	7.6W	11.4W	
Size (mm)	Ø70 x 80	140 x 225	140 x 405	
Colour	*Add lamp colour to code: WH (White), N (Matt Nickel Paint)			
Supply Voltage: 230VAC Colour Changing & White	 LED	 LED	 LED	 LED
Code	SLD40I1E	SLD40I2E	SLD40I3E	SLD40I4E
LED Power	6W	12W	18W	24W
Size (mm)	210 x 140 x 10.5	290 x 175 x 120	430 x 175 x 120	255 x 155 x 250

Indoor

LIGHTING

CEILING SPOT LIGHTS

Supply Voltage: 230VAC Lamp excluded						
Code	140010000	140010001	140160000	140160001	54185-1-*	54185-3-*
Power	50W	2 x 50W	50W	2 x 50W	1 x 25W	3 x 25W
Lamp Holder	GU10	GU10	GU10	GU10	E14	E14
Size (mm)	W120 x L144 x H138	W320 x L120 x H141	W100 x L125 x H146	W320 x L120 x H141	Ø120 x 120	Ø200 x 120
Material	Stainless Steel	Stainless Steel	Stainless Steel	Stainless Steel	Plastic + Steel	Plastic + Steel

* Add to Code: **W** (White) , **S** (Silver)

Supply Voltage: 230VAC Lamps excluded R50 Reflector				
Code	A448-1	A448-2	A448-3R	A448-3P
Power	40W Max	80W Max	120W Max	120W Max
Lamp Holder	E14	E14	E14	E14
Lamp Size (mm)	Ø61 x 140	140 x 160	140 x 160	Ø160 x 140
Turning Angle	270°	270°	270°	270°
Material	Stainless Steel	Stainless Steel	Stainless Steel	Stainless Steel

Supply Voltage: 230VAC Lamps excluded				
Code	SPL-026	SPL-027	SPL-029	SPL-030
Power	60W	60W	60W	60W
Lamp Holder	E27 CFL	E27 CFL	E27 CFL	E27 CFL
Colour	White	White	White	White
Description	1 x Lamp fitting	2 x Lamp fitting	3 x Lamp fitting	2 x Lamp fitting

NB: Only Reflective Lamps R60 to be used

Supply Voltage: 230VAC Lamps excluded			
Code	2RP-5410*	3RP-5410*	3BR-5410*
Power	2 x 50W	3 x 50W	3 x 50W
Lamp Holder	MR16	MR16	MR16
Colour	Stainless Steel	Stainless Steel	White
Description	2 x Lamp fitting	3 x Lamp fitting	3 x Lamp fitting

*Add fitting colour to code: **S** (Satin Silver) or **W** (White)

PICTURE LIGHTS

Low Voltage Supply Voltage: 230VAC Lamps excluded				
Code	WL-99177	WL-99369	MT1751-1W	MT1751-2W
Power	20W	2 x 20W	1 x 1W	2 x 1W
Lamp Holder	G4	2 x G4	LED	LED
Size (mm)	Ø6 x 300	Ø10 x 300	180 x 105 x 172	370 x 105 x 172
Material	Metal	Metal	Chrome	Chrome
Colour	Gold and Frosted White	Silver	Chrome / Frosted Glass	Chrome / Frosted Glass

2-year warranty on all LED products & 1-year warranty on battery-operated products, unless specified.
LED warranty void without surge protection. Refer to page 128.

PICTURE LIGHTING

Type: T5



Code	MB-059-8W	MB-059-14W	MB-059-21W
Wattage	5W	14W	14W
Size (mm)	350 x 320 x 330	614 x 180 x 120	914 x 180 x 120
Material	Matt Silver	Matt Silver	Matt Silver
Spare Lamp	FLT5-8	FLT5-14	FLT5-21



LED
4200K



LED
4200K

Code	MB-501A	MB-509
Wattage	5W	8W
Size (mm)	330 x 180 x 50	480 x 180 x 50
Material	Chrome	Chrome

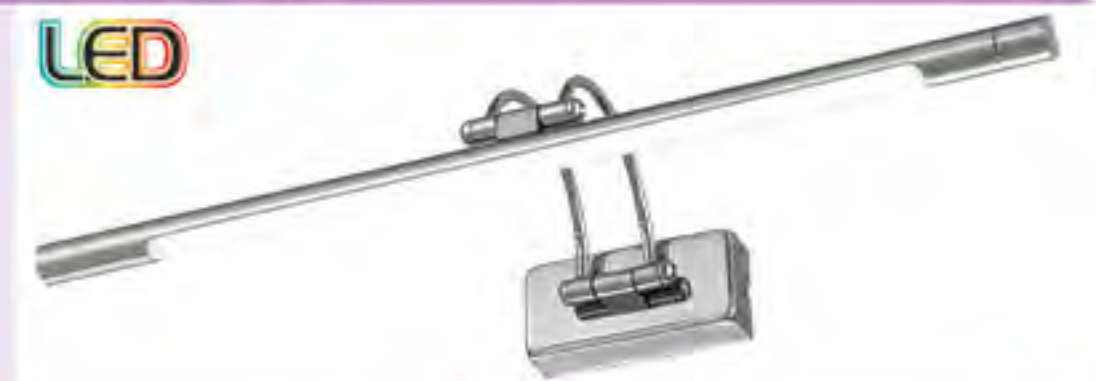

Code	MB-096-5W-*	MB-096-8W-*	MB-096-12W-*
Wattage	5W	8W	12W
Size (mm)	350 x 150 x 160	480 x 150 x 160	650 x 150 x 160
Material	Chrome	Chrome	Chrome

*Add colour to code: ○ **CW**(Cool White 4000k), ● **WW** (Warm White 3000k)

LINEAR CEILING LIGHTS

Input Voltage: 230VAC | LED Lamp Included



Code	MB-116-12W	MB-116-18W	MB116-2-12W	MB116-2-18W
Lamp Holder	LED	LED	LED	LED
Power	1 x 8W	1 x 13W	2 x 8W	2 x 13W
Size (mm)	665 x 60 x 100	965 x 50 x 75	665 x 140 x 100	965 x 60 x 100

Input Voltage: 230VAC | Material: Steel | Body Colour: Satin Nickel | LED Lamps included



Code	LED-401-2X9	LED-401-2X13	LED-403-2X9
Lamp	LED Tube	LED Tube	LED Tube
Power	2 x 9W	2 x 13W	2 x 9W
Size (mm)	665 x 105	1000 x 150	880 x 160

Input Voltage: 230VAC | Material: Steel | Body Colour: Satin Nickel | LED Lamps included



Code	LED-403-2X18	LED-404-2X9	LED-404-2X18
Lamp	LED Tube	LED Tube	LED Tube
Power	2 x 18W	2 x 9W	2 x 18W
Size (mm)	1480 x 160	790 x 210	1400 x 210

2-year warranty on all LED products & 1-year warranty on battery-operated products, unless specified.
LED warranty void without surge protection. Refer to page 128.

DECORATIVE CORD

Code	WLIT-C-* BL	WLIT-C-* BR	WLIT-C-* GN	WLIT-C-* GR
Description	Blue Cord	Brown Cord	Green Cord	Grey Cord
Code	WLIT-C-* R	WLIT-C-* BK	WLIT-C-* WH	WLIT-C-* Y
Description	Red Cord	Black Cord	White Cord	Yellow Cord

*Add length of cable to code: **2M, 5M, 10M, 100M** Material: Cotton | Size: 2 x 0.75 (6.2mm)

DECORATIVE ACCESSORIES

Code	TPLH-E27	LH-E27-WH	LH-E27-BK	LH-E27-CH
Description	E27 Lamp Holder	White E27 Lamp Holder Kit	Black E27 Lamp Holder Kit	Chrome E27 Lamp Holder Kit
Material	Black Thermo Plastic	Metal	Metal	Metal
Size	Ø40 x 60	Ø42 x 62	Ø42 x 62	Ø42 x 62
Code	LH-E27-VC	LH-E27-VB	LH-E27-VCH	LH-E27-VBK
Description	Vintage Copper Lamp Holder	Vintage Brass Lamp Holder	Vintage Chrome Lamp Holder	Vintage Black Lamp Holder
Material	Aluminium	Aluminium	Aluminium	Aluminium
Size	Ø50 x 72	Ø50 x 72	Ø50 x 72	Ø50 x 72



Code	CR-1-120-*	CR-2-120-*	CR-3-120-*	SHA-PL-5
Description	1 Way Rose	2-Way Rose	3-Way Rose	5-Way Shadow Plate
Material	Metal	Metal	Metal	Metal
Size (mm)	Ø120 x 25(L)	Ø120 x 25(L)	Ø120 x 25	Ø800 x 30

*Add body colour to code: **WH** (White), **BK** (Black), **CH** (Chrome), **BR** (Brass)



Code	BCR-1-100-E27*
Description	Ceiling Rose Kit
Material	Metal
Size (mm)	Ø100 x 25

*Add body colour to code: **VC** (Vintage Copper), **B** (Bronze), **VBK** (Vintage Black)

10 Per Pack						
Code	THT-25/10	THT-120/10	LNUT-M10/10	LWASH-M10/10	CG-13/10-*	NWCg-13/10
Description	Threaded Tube	Threaded Tube	Nut	Washer	Cable Grip	Cable Grip
Material	Metal	Metal	Metal	Metal	Plastic	Plastic
Size (mm)	M10 x 25	M10 x 120	M10	M10	Ø13 x 17	Ø13 x 17

*Add body colour to code: **WH** (White), **BK** (Black), **T** (Transparent)

LIGHTING ACCESSORIES

Rocker Switch  Black White R-303B R-303W 2 Amp 250V 2 Amp 250V		On/Off switch with 1.5m cable to 2 pin Euro Plug & 1m wire open ended for lamp  R-313W 2 Amp 250V		Foot Operated Switch  Black White ZE-127FB ZE-127FW 1 Amp 250V 1 Amp 250V		Latching Pushbutton Switch  Black White ZE-127B ZE-127W 6 Amp 250V 6 Amp 250V		
Hand Operated Table Lamp Dimmers c/w 2,5m cable  White Black White Clear KLD-227W KLD-227G RT101B RT101T			Touch control NEW  White Clear RT101SB RT101ST		Foot Dimmer NEW  RT81N	Breather NEW  M12-1.5/5	Luminaire Disconnect Connector - 2 Pole, Yellow  NEW 873-902	
Push-in Terminal Blocks NEW  LT-2P-LN LT-3P-LNE Push-in & Neutral Terminal Black Push-in Live, Earth & Neutral Terminal Black		Knife Switches  M29-3P-S M29-3P-L 3 Pin I Rated 400V I Class II 27 x 20 x 27 3 Pin I Rated 400V I Class II 40 x 30 x 40		Surge Protectors - Can be installed in fitting or junction box See pages 10.1 - 10.7 for surge protection for distribution boards U  NEW IP67 LP2-8 M995* GSPD1 GSPD1S Connection Vc Up I _{max} (8/20) Parallel 275VAC 710V 5kA Series 120-277VAC ≥1000V 10kA Parallel 120 - 277VAC ≥1500V 20kA Parallel 120 - 277VAC 850V 10kA				
* Max Load Current = 3A - NOTE: Load will be disconnected when SPD reaches end of life								

LAMP HOLDERS

Metal Lamp Holders

10mm  0142 Authorisation Certificate No. XE2377A CLH22-10B B22	 XE2377B CLH22-0B B22	10mm Entry  YE317A CLH22-10SW B22 (switched)	 CLH27-0B E27	 CLH27-10B E27	 CLH14-0B E14
--	--	--	---	--	---

Nylon Lamp Holders

Illumination Cable & Cable Piercing Lamp Holders

 W626 E27 Angle	 F505-E27 Base Mount E27 100W	 ALH40-0B E40 Batten Mount Aluminium	 CLH14-TH-* E14 2A 250V	 CLH27-TH-* E27 2A 250V	 393 B22 Cable Piercing Type	NEW  W100* BK 100m Black Illumination Cable *Add length to code 5m, 10m, 20m, 50m
Spare Locking Ring Code CLH14-THLR-* CLH27-THLR-* *Add colour to code: WH (White), BK (Black)						

LAMP HOLDERS

Nylon Lamp Holders		Porcelain Lamp Holder	Bakelite Lamp Holder	Ceramic Lamp Holders	
CLH200-*	CLH209A-*	CLH22-1P	CLH200T	CLH27-1P	CLH40-1P
B22	B22	B22	E27	E27	E40

*Add colour to code: ○ WH (White), ● BK (Black) CLH200,CLH209A Also available in pack of 5 Add /5 to code

Lamp Holders					Fluorescent Lamp Holders		
HL001	HL002	W602-B22	W617	W622	PT-C01 (set)	PT-C02	PT-C06
B22 / E27 Both Fitted	B22 / E27 Both Fitted	B22	B22 Angle	E27	G13	G13	G13

Fluorescent Lamp Holders

PT-C07	PT-C08	PT-C05	PT-C09 (set)	LH2-ST-L	LH2-ST	D-GUB
G13	G13	G5	Slimline	GU10 lamp holder L Bracket c/w ceramic lamp holder & terminals	GU lamp holder c/w terminals & bracket	GU lamp holder c/w terminals & bracket

Code	MR16-1U/10	MR16-3U/10	MR11-1U/10	D-CLIP1	D-CLIP2	D-CLIP2/10
	Spare clip for MR16	Spare clip for MR16	Spare clip for MR11	Spare mounting clip fits SL-076 & 250	Spare mounting clip fits SL-203	Spare mounting clip fits SL-203 Sold in Packs of 10

Dichroic Lamp Holders

Code	CLH202	CLH205	CLH206	CLH207	CLH208	CLH209
Type	MR16 (G5.3)	MR16 (G5.3)	MR16 (G5.3)	MR16 (G5.3)	GU10	GV10 (GZ10)

Rx7s Lamp Holders			
Code	Description	CLH210	CLH211
RX7S-78	To accept 78mm. Lamps up to 150W	G9	G12
RX7S-118	To accept 118mm. Lamps 150W-500W		
RX7S-189	To accept 189mm. Lamps 1000W		
RX7S-254	To accept 254mm. Lamps 1500W		

LAMP HOLDERS

Starter Holders

						
Code	PT-B09	PT-B03	A321	CLH22-BT	LH47-E27	LHA-E27-1.5m
Description	Starter / Fuse link base with mounting bracket	Starter / Fuse link base	Ceiling Mount Pull Switch 10A	B22 Batten-mount lamp holder with 4m cable, on/off switch and battery clamps 70W max	Pendant - 100W E27 Lamp Holder	E27 Lampholder Adaptor with 1.5m 2 x 0.75mm cable





Lamp Holder Adaptors - <500V

						
Code	LHA-01	LHA-02	LHA-03	LHA-04	LHA-10	LHA-05
Description	B22-E27	E27-B22	E27-E40	E27-GU10	B22-GU10	E40-E27
Size (mm)	52 x Ø34	50 x Ø33	80 x Ø47	44 x Ø29	52 x Ø35	52 x Ø44

Lamp Tester

				
Code	LHA-07	LHA-08	LHA-09	LT5020
Description	E14-E27	E27-E14	E40-E40	Buzzer & LED indication if lamp is in working condition. To test: G13, B15d, G5, G4, Gu5.3, GY6.35, E27, E14, E10
Size (mm)	Ø40 x 64	Ø29 x 44	Ø47 x 99	

SENSOR LAMP HOLDERS

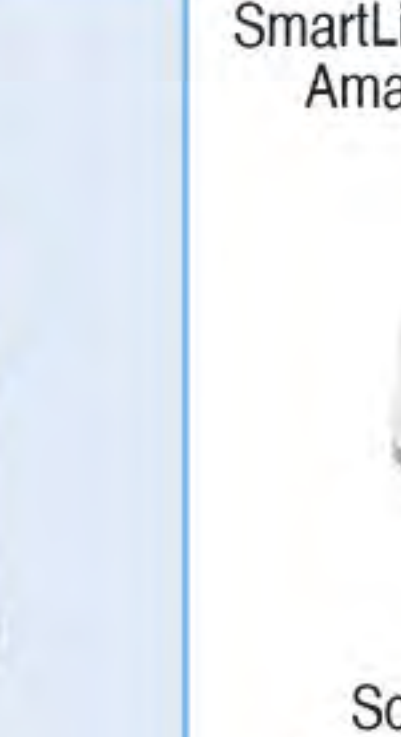
	Motion Sensor		Lamp Holders with Daylight Sensor		Sound Sensor
					
Code	RW-450	RW-451	RW-470	RW-471	RW-480
Volts	220-240VAC	220-240VAC	220-240VAC	220-240VAC	220-240VAC
Output	60W (max)	60W (max)	60W (max)	60W (max)	60W (max)
Range/ Angle	6m/120°	6m/360°	-	-	-
Size (mm)	Ø 64 x 127	Ø 56 x 132	Ø 55 x 98	Ø 38 x 75	Ø63 x 95
Light On Timer	120sec	120sec	-	-	60 sec
Ambient Lux	<10lux	<10lux	<10lux	<10lux	3-5lux

2-year warranty on all LED products & 1-year warranty on battery-operated products, unless specified. LED warranty void without surge protection. Refer to page 128.

HIGH FREQUENCY SENSOR MODULE



- 1) Time
- 2) Lux
- 3) Meter
- 4) Standby

2 Level Light Dimming Function

Code	HD-627DF	HD-627TF
Rated Voltage	220-240V ~ 50/60Hz	220-240V ~ 50/60Hz
Switching Capacity:	Max. 100W	10 - 100W
Incandescent	Max. 60/80/100W (electronic) / Max. 80W	10 - 100W / 10 - 100W
AC Halogen / LV Halogen	Max. 100VA/60W	5 - 80W (LED Lamp Dimmable)
Flourescent / LED Lamp	Max. 30mA Sink Current	10-100VA (Dimmable)
Energy Saving Lamp	Max. 15pcs Dimmable	-
1-10VDC Interface	Ballast or LED Driver	-
Range/Angle	Approx. Ø 8m	Approx. Ø 8m
Size (mm)	75.5 x 49.5 x 32.5H	75.5 x 49.5 x 32.5H
Light ON Timer	5sec - 30min & Test	5sec - 30min & Test
Lux	5Lux - "☀️" ∞	5Lux - "☀️" ∞
	<ul style="list-style-type: none"> • Auto Dimming - No movement dims to set level on unit - With movement full power 	

PIR SENSORS IP20



Low Profile

Zero Point Relay Switching



Long Range - 12m

Zero Point Relay Switching



Optional remote controller Code: **MANDOCR**

Code	CIRCUMAT +	CIRCUMAT PRO CR
Voltage	230VAC	230VAC
Output	1200W Incandescent 400VA Fluorescent 1000VA Low Voltage (12VAC) Halogen Lamps 1200W Halogen (230VAC) 500VA Low Consumption Lamps 500VA Downlight Lamps 500VA LED	2200W Incandescent 1200VA Fluorescent 2000VA Low Voltage (12VAC) Halogen Lamps 2200W Halogen (230VAC) 1000VA Low Consumption Lamps 900VA Downlight Lamps 500VA LED
Range Angle	9m / 360° at 3m(H)	30m / 360° at 12m(H)
Size (mm)	Ø120 x 25	Ø140 x 68
Light on Timer	3s - 30min	1-10min
Lux	5 - 2000Lux	10-1000Lux

DALI - Presence Detection Equipped with DALI Two-Way Communication



1-10V - Analog Output for Dimmable Lighting Control | Adjust Indoor Lighting Based on Natural Outdoor Light | Suitable for 1-10V Dimmable Lamps



1-10V - Presence Detection with Analog Output 1 -10V for Dimmable Lighting Control



Code	CIRCUMAT-DALI	DICROMAT1-10V	CIRCUMAT PRO 1-10V
Voltage	230VAC	230VAC	230VAC
Output	-	1200W Incandescent 500VA Fluorescent 1000VA Low Voltage (12VAC) Halogen Lamps 1200W Halogen (230VAC) 500VA Low Consumption Lamps 500VA Downlight Lamps 500VA LED	2200W Incandescent 1200VA Fluorescent 2000VA Low Voltage (12VAC) Halogen Lamps 2200W Halogen (230VAC) 900VA Low Consumption Lamps 900VA Downlight Lamps 500VA LED
Range Angle	30m / 360° at 3.5m(H)	10m / 360° at 2.5m(H)	30m / 360° at 12m(H)
Size (mm)	Ø140 x 68	Ø76 x 68.5	Ø140 x 68
Light on Timer	10s - 30min	10s-30min Twilight mode (On<60 lux, Off>400 lux)	10s-30min
Lux	10 - 2000 lux	100 lux - 2000 lux	10-1000 lux

MICROWAVE MOTION SENSORS



Small size allows unit to be mounted inside the light fitting.



Can be surface mounted or hidden in ceiling. Very sensitive.

Fixed 5.8GHz



Code	JQ-25	ECOMAT	ES-M12
Volts	220-240VAC	230VAC	230VAC
Output	1200W Incandescent 500W Fluorescent 500W LV Halogen	1000W Incandescent 500W Fluorescent 500W LV Halogen	1200W Max
Range/ angle	1-8m/ 360°, 160°	6m/270° at 1.7m(H)	10m / 360°
Size (mm)	75 x 41 x 43	116 x 78 x 42	Ø98 x 56mm / cutout Ø76mm
Light On Timer	8sec-10min	3s - 30min	10s - 1, 5, 10, 15, 20, 25, 30min
Lux	< 5 Lux - 2000lux	0.5 - 2000lux	10, 20, 50, 100, 200, 300, 500lux

RECESSED PIR & MICROWAVE SENSORS IP20

Input Voltage:
220-240VAC

Fixed PIR Sensor

Tiltable



Code	ES-P14	ES-P17A	ES-P17B	ES-P17C	ES-P27B
Detection Angle	360°	360°	360°	360°	360°
Detection Distance	6m Max	6m Max	6m Max	2-20m	6m +
Load	500W Max	1200W Max	1200W Max	2000W (Incandescent) 1000W (Energy Saving)	1200W Max
Time Min/Max	10sec-7min	10sec-7min	10sec-7min	10sec-7min Adjustable	10sec-7min
Lux Min/Max	<10lux - 2000lux	<10lux - 2000lux	<10lux - 2000lux	<10lux - 2000lux Adjustable	<10lux - 2000lux
Dimensions	Ø50 x 66mm	Ø76 x 76mm	Ø100 x 76mm	Ø110 x 90mm	Ø85 x 59mm
Cutout	Ø40mm	Ø61.5mm	Ø76mm	Ø76mm	Ø68mm

PIR MOTION & LIGHT SENSORS

Ceiling

Ceiling IP20

Flush

Wall IP44



Fits standard 4x2 boxes



Code	ST24	OS-460	OS-472B	OS-472B-A	F4000
Volts	220-240VAC	220-240VAC	220-240VAC		220-240VAC
Output	800W Incandescent Lamp 200W Low Voltage or Fluorescent Lamp	1200W Incandescent	800W Incandescent	200W Incandescent	1300W Incandescent Lights 300W Fluorescent Lights
Range/Angle	360°	11m/360°	Detection Angle 8m/180°		Detection Angle 12m/180°
Size (mm)	Ø18	110 Ø x 32H	115H x 73W		75 x 100 x 115
Light On Timer	5s to 8min	10s to 7min	10s - 7min	10s - 7min	10s to 7min
LUX	10/2000lux	Adj. 3 - 2000 lux	<10-2000lux	Adj. <10-2000lux	Adj. 3 - 2000lux
	Passive Infra-Red sensor for automated control • Tiny sensor ball of 35mm Ø • Cut-out hole size 33mm Ø	Built-in photocell allows automatic operation at night and disable during daylight	• No blind spots • Can replace existing 1 way or 2 way switch • No neutral required for OS-472B-A		• Complete with wall bracket

2-year warranty on all LED products & 1-year warranty on battery-operated products, unless specified. LED warranty void without surge protection. Refer to page 128.

PIR MOTION & LIGHT SENSORS

	Flush	Surface - Flush	Surface
Code	OS-465	FL380	OS-462
Volts	220-240VAC	220-240VAC	220-240VAC
Output	Two loads: L' = 10A for incandescent T1-T2=10A max voltage free contact	2000W Incandescent 1000W ESL	Two loads: L' = 10A max T1-T2=10A max voltage free contact
Range/Angle	6m/360° at 2.4m (H)	12m/360° at 4m (H)	6m/360° at 2.4m (H)
Size (mm)	80Ø x 51 / 110 x 53 x 30	124Ø x 82	113Ø x 39
Light On Timer	L': 6s - 12min, T1-T2:10s - 30min	10s-7min	L': 6s - 12min, T1-T2:10s - 30min
LUX	Fully adjustable Flush mount in ceiling. Dual load for light & ventilation. One additional sensor extendable. Code: OS-465S	<10 - 2000lux 3 x Detector for High sensitivity	Fully adjustable Plug in terminal block for easy installation. Dual load switching 4 element sensor for high sensitivity.

	Ceiling or wall IP45	Ceiling or wall IP44			
Code	OS-181C	JQ26 230VAC	JQ26 12VDC	JQ701	JQ43
Volts	230VAC	220-240VAC	12VDC	220-240VAC	220-240VAC
Output	1840W Incandescent 1000W HV Halogen 300VA LV Halogen 400VA Fluorescent	1100W Incandescent Load	120W Incandescent Load	600W Incandescent load	150W Incandescent load
Range/Angle	10m/270° at 2.5m(H)	12m/180° at 2m(H)		6m ± 2m/ 360°	6m ± 2m/ 360°
Size (mm)	129 x 80 x 63	220 x 86 x 55		85L x Ø73	64L x Ø45
Light On Timer	6s - 10min	8s - 6min		8s - 6min	5s - 8min
LUX	5lux-2000lux Can be fitted to wall or ceiling or a corner. Waterproof. Test function.	2 lux - Daylight Fully weather proof and easy to install.		3 lux - Daylight Easy to mount. Cut-out: Ø56.5mm	10 lux - 2000 lux Easy to mount. Cut-out: Ø40mm

AIR CONDITONER OCCUPANCY SENSOR

Reduce Energy Costs by up to 80%

EcoSense copies the "off" signal from the A/C remote controller, thereby ensuring the A/C goes through its correct shut down procedure

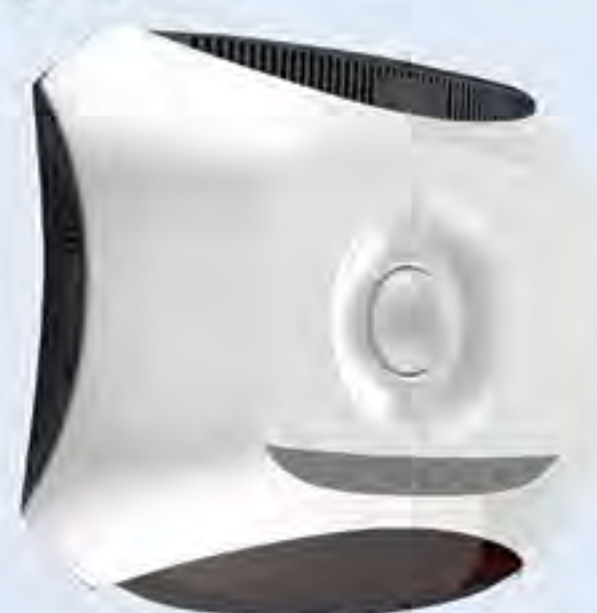

ECO 2000/4001



ECO-RC



ECO-WD



ECO-PS

Eco 2000

Code	ECOS-2000
Supply Voltage	5x AAA battery (no mains required)
Description	EcoSense 2000 will scan the room for occupancy, when no occupancy has been detected after a pre-set time delay. A signal will be transmitted to the A/C to switch off

Eco 4001

Code	ECOS-4001
Supply Voltage	110-230VAC
Description	Universally compatible with any A/C that can be operated by remote controller. This model is mains powered and can be fitted directly adjacent to your A/C unit, therefore no connecting cables will be visible. Compatible with wireless accessories to further increase efficiency.

Accessories for ECOS-4001

Code	Description
ECO-RC-PLUS	Intelligent remote control to limit temperature range
ECO-WD	Wireless door and window sensor - switch off the air conditioner if a door/window is open
ECO-PS	Wireless PIR sensor - for extending detection range

REMOTE CONTROL MICROWAVE SENSOR / DIMMING FUNCTION IP65



MC054V-RC-A



MH01



MS01

Microwave Sensor - Parameters can be conveniently set by remote control or via dip settings | Automatic dimming when used in combination with 1-10V dimmable control gear | 1-10V interface can match up stand-alone daylight sensor **MS01** and achieve daylight harvesting

Code	MC054V-RC-A
Rated Load	400W @ 120VAC, 800W @ 220-277VAC (Inductive), 800W @ 120VAC, 1200W @ 220-277VAC (Resistive)
Detection Area	5-7m @ 8m Mounting Height
Hold Time	5s / 30s / 1min / 3min / 5min / 10min / 20min / 30min
Daylight Sensor	Dip Switch & Remote Control 5lux / 15lux / 30lux / 50lux / 100lux / 150lux / disable
Stand-by Period	0s / 10s / 1min / 3min / 5min / 10min / 30min / + ∞
Stand-by Dim Level	10% / 20% / 30% / 50%
Mounting Height	15m Max.
Motion Detection	0.5 ~ 3m/s
Detection Angle	150° (Wall Installation) 360° (Ceiling Installation)
Size	Ø72 x 59mm

Remote Control - Works in conjunction with **MC054V-RC-A**

Code	MH01
Description	Remote Set-up Control

Daylight Sensor / Photocell (for Daylight Harvesting) - Works in conjunction with **MC054V-RC-A**

Code	MS01
Operating Voltage	1 - 10VDC
Dimming Range	10% - 100%
Mounting Height	3 - 4m
Daylight Sensor	100 - 1000lux
Size	Ø21.5 x 60mm

DAYLIGHT SWITCHES



Code	CA-22015	CA-22006	LA10	LA16	LA16-VDC	LC-10	LC-11	CDS-15A
Light Off Delay Timer	-	-	30sec		30sec	-	-	60sec
Load	15A	6A	10A	16A	16A @ 12-30VDC 1.5A @ 31-48VDC	10A	-	200W fluorescent 1000W incandescent
Lux	Fixed On 31.5 / Off 12.5 Lux		Fixed On 60 Lux / Off 40 Lux			On ≤ 20Lux / Off ≥ 80 Lux		Adj. 5-300 Lux with LED Lux adj. indication

Panel Fitted Daylight Switch

WITH BLUE TOOTH

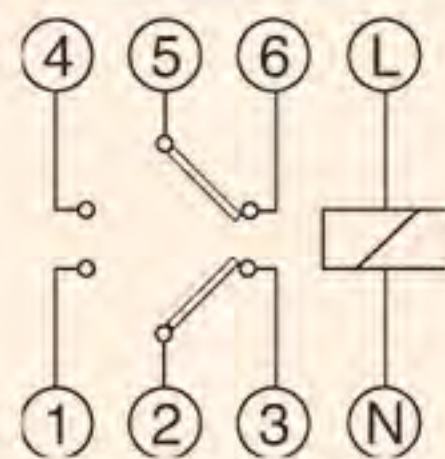

Astro Nova fits inside your distribution board. Enter in your co-ordinate or city & it will control your lights perfectly!

Code	ASTRO NOVA
Accessory (Bluetooth Dongle)	OB709971
Power Supply	230VAC (6VA)
Switching Capacity	16(10)A/250V AC 2C/O
Operating Accuracy	±1sec/day at 23°C
Switching Accuracy	Better than 1 second
Battery Back-up	10 years (Lithium battery)
Memory Spaces	22
Auto change summer/winter	Yes
Max Recommended Load	
Incandescent	3000W
Non-compensated Fluorescent	1200W

OR1

Daylight Switch IP65



Size 95(D) x 32(W) x 46(H) mm

Code	MS15
Timer	20sec
Load	16A
Lux	Fixed On 60Lux / Off 40Lux

Mini Daylight Switch



Code	JQ45	JQGM01
Timer	-	-
Load	100W	32W
Lux	< 10 Lux	< 10 Lux

DC Daylight Switch



Code	LR5 12VDC
Timer	-
Load	6A
Lux	Fixed On 60Lux / Off 40Lux

CONTROLLERS FOR LED STRIPS

Code	MINI-RGB	MINI-RGBW	MINI-SINGLE	MINI-AMP	MINI-WIRELESS-RGB	MINI-WIRELESS-RGBW	RGB-LINK/5
Description	12VDC Colour Controller	12VDC Single Colour Controller Dimmer	12VDC Single Colour Controller Dimmer	RGB LED Amplifier to be used every 5 meters	RF Wireless RGB LED Controller	RF Wireless RGBW LED Controller	4 Pin RGB Link
Watts	Max 144W	Max 144W	Max 144W	-	Max 144W	Max 144W	-

Code	SP106F	RGBW-AMP	GT-2601	WD95-DC12	WLD95-DC12	DC-PWM-96W-LED
Supply Volts	12VDC	12 - 24VDC	12VDC	12VDC	12-24VDC	9VDC-48VDC
Description	RGB Amplifier 48W (4A)	RGBW Amplifier 4 Channel, 6A per Channel	RGB Controller 6A per Channel	Wired dimmer 96W (8A)	Wireless dimmer 48W (4A)	No minimum load Suitable for 12VDC and 24VDC strip LED's Digital control provides accurate and flicker free dimming to very low intensity
Size (mm)	104 x 65 x 24	115 x 72 x 42	105 x 75 x 29	89 x 59 x 35	65 x 39 x 22	36 x 36 x 12

DC PWM Bell Press Dimmer - Ideal for LED Strip Light I for zone controlling see dimmer section in accessories.

NEW

Code	SP107F	FUT-005N	FUT-022	FUT-025	RGBW-CON
Supply Volts	12/24VDC	12/ 24VDC	12-24VDC	12-24VDC	12-24VDC
Description	RGB Controller with remote for preloaded programs (Fading & Flashing effects) 45 Watts (4A) per channel. 9 Changing Patterns.	LED RGB Controller with remote control. Dimming function & 15 colour changing patterns set via remote. 6A per channel. Direct colour selection via colour wheel.	Colour temperature adjustable and dimmable. 6A per Channel.	RGB Colour changing and dimmable. 6A per Channel.	RGB+W Colour changing and dimmable. 6A per Channel.

Accessories

LIGHTING

NEW

STAIRWAY LIGHTING CONTROLLERS



MLU300-IR-WR

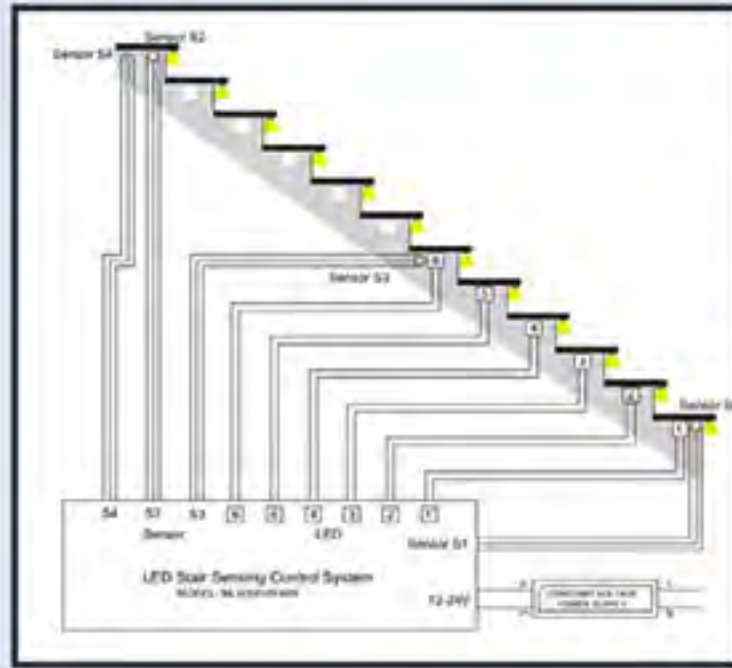

ELU300-D1-IR

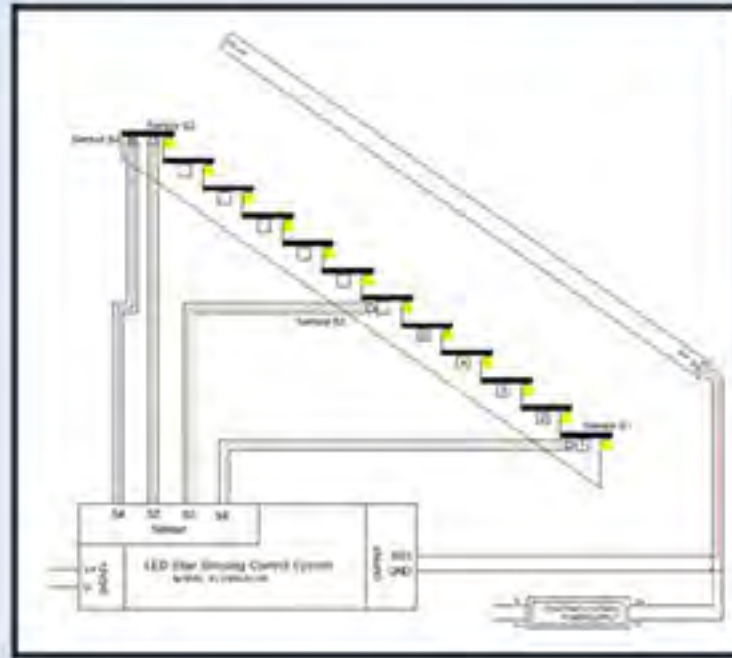

DMX Stair Case Lighting - The DMX controller is used for Dynamic Lighting of the stairs. The back light is switched on with the subsequent step, depending on motion direction: ascending or descending

Controller

Code	Input/Output Voltage	Input Signal Channels	Output Channels	Size
MLU300-IR-WR	12-24VDC	4	50 Max	168 x 39 x 30

Decoder

Code	Input/Output Voltage	Input Signal Channels	Output Channels	Size
MLU500-3-8A	12-24VDC	4	3	168 x 39 x 30
MLU500-4-8A	12-24VDC	4	4	168 x 39 x 30
MLU500-5-8A	12-24VDC	4	5	168 x 39 x 30

Pixel Handrail Lighting - The LED Handrail controller is used to create a meteor effect on the handrail. The effect will depend on motion direction: ascending or descending. Only Compatible with WS2811 IC LED Strip

Controller

Code	Input/Output Voltage	Input Signal Channels	Output Channels	Size
ELU300-D1-IR	12VDC	4	1	168 x 39 x 30

Accessories

Code	Description
MLS008-PIR	Motion Sensor - Used to trigger direction
MLS008-BRC	Day light sensor
IR-K2	IR Remote Control - Program Scenes

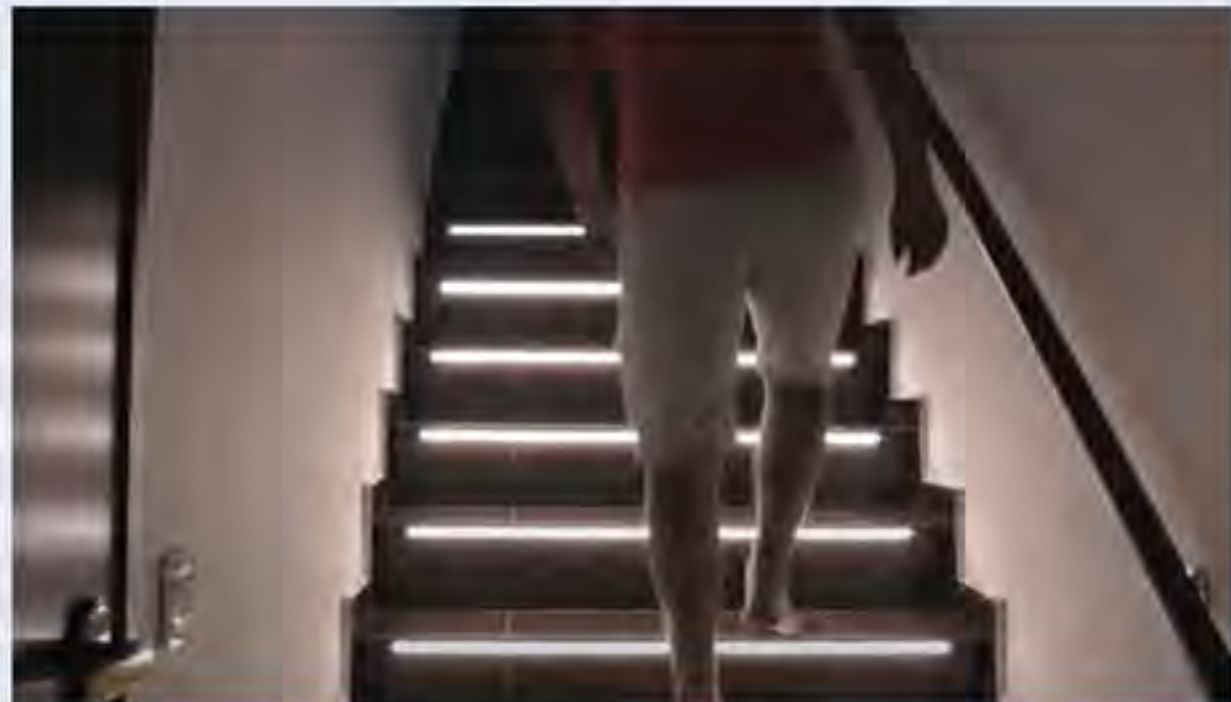

SMART LED STRIP LIGHT DIMMER & CONTROLLERS IP20



ES-TDS01



ES-WDS01



Touch (On / Off & Dimming) - Metal body | Touch time < 2 seconds, on / off function | Touch time > 2 seconds, dimming will gradually rise to full brightness, alternatively lower brightness

Wave (On / Off & Dimming) - Wave your hand in front of dimmer | Waving time < 2 seconds, on / off function | Touch time > 2 seconds, dimming will gradually rise to full brightness, alternatively lower brightness

Code Touch	Code Wave	Input Voltage	Function	Max. Power
ES-TDS01	ES-WDS01	DC12V / DC24V	Single Colour	36W at DC12V 72W at DC24V



IR Sensor

IR Sensor Switch - Normally mounted in wardrobe and drawer | Open door, light ON | Close door, light OFF

Code	Input Voltage	Function	Max. Power
ES-IRS03	DC12V / DC24V	Single Colour	36W at DC12V 72W at DC24V



ES-BDS01



ES-BDS02



ES-BDS03



Bluetooth Controller - Bluetooth 4.1 | Support IOS & Android | Download "Wilight" from Apple Store or Google Play | Search the connected light | Control the light by "Wilight" App

Wi-Fi Controller - Remote control LED lamps by App | Support 16 million colour selection and brightness control | Timing function, set schedule to switch on/off lights | Colour change with rhythm of music on smart device | Works with Amazon Alexa & Google home, control lights by voice



ES-WFD01



ES-WFD02



ES-WFD03



Code Bluetooth	Code Wi-fi	Input Voltage	Function	Max. Power
ES-BDS01	ES-WFD01	DC12V / DC24V	Single Colour	36W at DC12V 72W at DC24V
ES-BDS02	ES-WFD02	DC12V / DC24V	RGB	36W at DC12V 72W at DC24V
ES-BDS03	ES-WFD03	DC12V / DC24V	RGBW	36W at DC12V 72W at DC24V

Accessories

LIGHTING

DIMMERS



Shuttle Dimmers & Controllers - LED Dimmers with no Minimum Load/Under Voltage, High Frequency AC Transient & Surge Protection | Fits in Standard 4 x 2 Boxes | Create your own Dimmer with your choice of Plates | Trailing or leading Edge Dimming Method

Dimming Method		Universal Dimming (Leading & Trailing) Default Trailing			NEW PWM 0-10V / 1-10V	NEW DC PWM 9-48VDC
Watts	Amps	Tactile Code	Rotary Code	Tactile Code	Rotary Code	Bell Press Code
96W	2-10A	-	-	-	-	DC-PWM-96W-LED
125W	0.55A	DM-125W-LED	-	-	-	-
225W	1A	-	DMR-225W-LED	-	-	-
500W	2.2A	DM-500W-LED	DMR-500W-LED	LDM-500W-LED	-	-
800W	3.6A	DM-800W-LED	DMR-800W-LED	-	-	-
1800VA	10A	-	-	-	SDIMR-1-10V-1800VA	-

Note: Please refer to Shuttle Compatibility list to confirm max number of lamps per dimmer | www.shuttlelighting.com

Code	Description
DM-MZC	Allows co-ordinated or independant control of multiple tactile dimmers

UNI-
VERSAL



Universal Dimmer - Compatible with all types of lamps except constant power lamps | Dimmer control bell press & digital control

Code	DIM-CG-100
Input Voltage	230VAC
Dimming Range	100%
Max. Load	5-100W
Load Type	Fluorescent / LED / Halogen / CFL / Incandescent
Size (mm)	50 x 50



Compact Universal Dimmer Easy to turn a traditional switch into a intelligent LED dimmer | Bell Press or Rocker Switch

Code	890300
Input Voltage	230VAC
Dimming Range	100% (6% Steps)
Max. Load	1-100W
Load Type	LED
Size (mm)	36 x 36 x 12



- CE Approved
- EMC Low Noise
- 470kΩ Pot supplied
- Incandescent or Halogen Lamps

Industrial Dimmer

Code	Rating	Size (mm)
RTS38	230V 1400W	115 x 105 x 65

ORBIS DIMMER & TIMERS

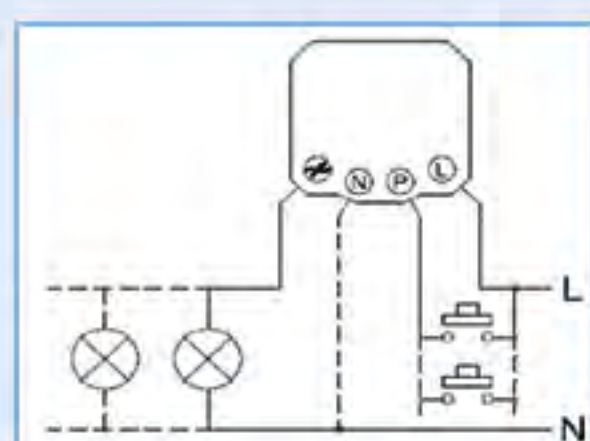

Orbis LED Dimmer - All Dimmable lamps except 12VDC LEDs operating with electromagnetic transformers | Suitable for Leading and Trailing Edge lamps | Neutral connection not required, only required for LED lamps that flicker or do not turn off | Suitable for 2-way switching

Code	DIM-LED
Input Voltage	230VAC
Adjustment Type	Lamp 1 (Trailing Edge), Lamp 2 (Leading Edge)
Installation	Optional Neutral Connection (based on lamp characteristics)
Minimum Load	3W
Maximum Load	100VA (LED)

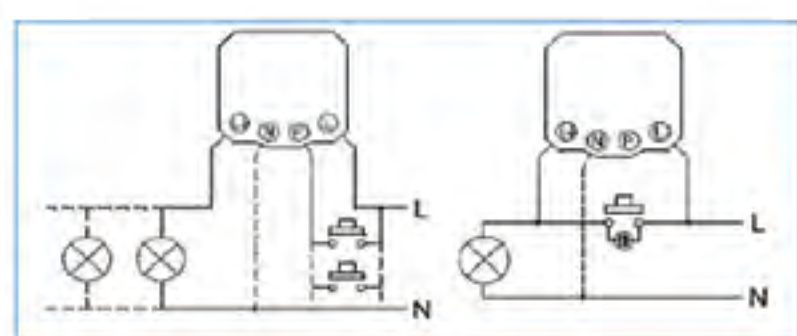

Orbis LED Timer - All lamp types, except LEDs operating with electromagnetic transformers or any type of fluorescent lights | Adjustable timing | Resettable | Additional push buttons can be fitted | Provides for fans and extractor control.

Code	TEMPO-LED
Input Voltage	230VAC
Timing Range	15s - 15min
Installation	Optional Neutral Connection (based on lamp characteristics)
Minimum Load	3W
Maximum Load	100VA (LED), 50VA (Extractor Fan)

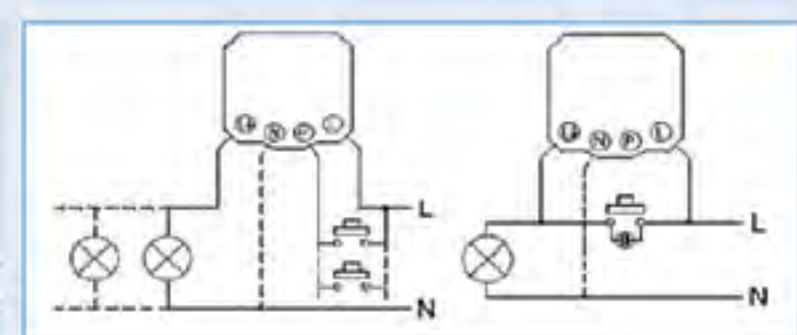

Orbis LED Timer & Dim - Initial 100% Lighting intensity during set time. Adjustable from 15s - 15min | After the set time has expired, light intensity is reduced to 25% maintaining a courtesy or safety level of light, either permanently or for a limited period of time (between 7min and 5min). Suitable for all dimmable lamps, except LEDs 12VDC operating with electromagnetic transformers.

Code	TEMPO-LED-2N
Input Voltage	230VAC
Timing Range	15s - 15min
Standby Lighting Timer	1-5min / ∞
Installation	Optional Neutral Connection (based on lamp characteristics)
Minimum Load	3W
Maximum Load	100VA (LED)

DMX CONTROLLERS



Code	DMX-512-12V	SRC-174	SRC-144
Description	<ul style="list-style-type: none"> • 5 Channels, each channel 8A, 480W@12V, 960W@24V. • RJ45, 5 Pin XLR or 3 Pin XLR screen terminal selectable. • 1ch to 5 ch selectable • PWM Output resolution ratio 8 bits, 16 bits selectable. • PWM Frequency selectable from 500Hz - 9KHz. • Dimming curve gamma value selectable from 0.1 - 9.9 	<ul style="list-style-type: none"> • Allows you to program 12 scanners with 16DMX channels each, • 30 banks of 8 programmable scenes, 6 chases of 240 scenes using 8 channel sliders, a joystick, and other buttons. • With the ease of the joystick, you can accurately control the movement of a fixture. • In addition, two units can set up communication so that they can send or receive a complete file dump. • Fog machine output and activation button. 	<ul style="list-style-type: none"> • 230VAC 52 Channel DMX Controller • Easy-to-use DMX controller for programming up to 9 intelligent lights • 52 Channels with 9 projector banks of 4 channels each • Scene, program and projector LED displays • 9 programs with up to 50 steps per program • Fade and Speed Control • Built-in microphone for sound-active mode • DC 9V power supply included

DMX DECODERS

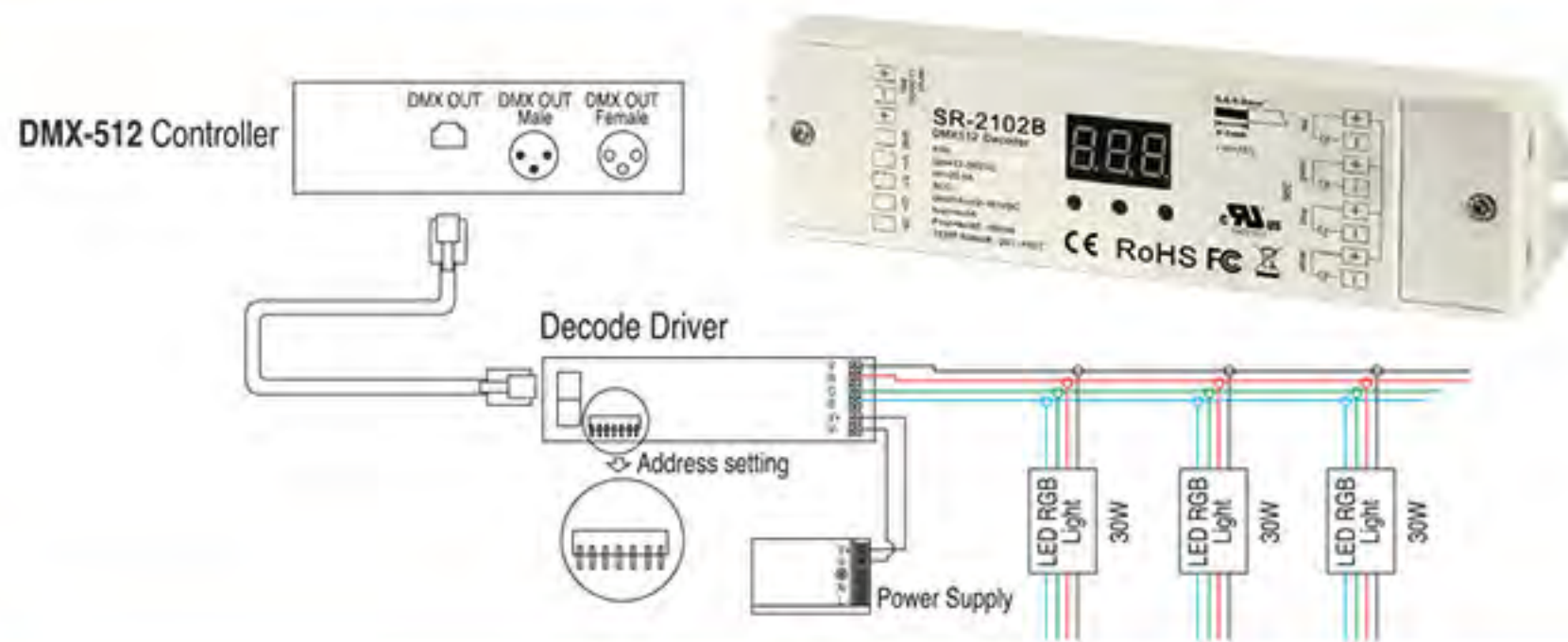

DMX 512 Decoder

Code	IMG-DV512
Input Voltage	12-36VDC
Load Current	4ch, 5A
Load Power	240W@12V, 480W@24V, 720W@36V
Output Signal	PWM
Decoding Signal	DMX512
RGB Changes	1
Size (mm)	130 x 40 x 35

BOX TYPE SWITCH MODE POWER SUPPLIES

Chassis Mount Supply Volts: 170 - 260VAC

- Output Accuracy: $\pm 2\%$
- Load Regulation: $\pm 2\%$
- Overload Protection
- Short Circuit Protection



BC1

Watts	Code 5VDC	Amps	Code 12VDC	Amps	Code 24VDC	Amps	Code 48VDC	Amps	Size (mm) W x L x H
15W	SNP-15W/5	3A	SNP-15W/12	1.3A	—	—	—	—	70 x 39 x 31
25W	SNP-25W/5	5A	SNP-25W/12	1.7A	SNP-25W/24	1.1A	—	—	80 x 48 x 22
40W	—	—	SNP-40W/12	3.5A	SNP-40W/24	1.8A	—	—	110 x 79 x 35
60W	SNP-60W/5	10A	SNP-60W/12	5A	SNP-60W/24	2.5A	SNP-60W/48	1.25A	110 x 79 x 35
100W	SNP-100W/5	20A	SNP-100W/12	8.5A	SNP-100W/24	4.5A	—	—	129 x 98 x 38
120W	—	—	SNP-120W/12	10A	SNP-120W/24	5A	SNP-120W/48	2.5A	129 x 98 x 38
150W	—	—	SNP-150W/12	12.5A	SNP-150W/24	6.2A	—	—	160 x 98 x 50
200W	—	—	SNP-200W/12	16.5A	SNP-200W/24	8.3A	SNP-200W/48	4.2A	160 x 98 x 50
250W	—	—	SNP-250W/12	20A	SNP-250W/24	10A	SNP-250W/48	5A	160 x 98 x 50
350W	—	—	SNP-350W/12	30A	SNP-350W/24	15A	SNP-350W/48	7.5A	199 x 98 x 50
480W	—	—	—	—	SNP-480W/24	20A	—	—	240 x 125 x 65

2-year warranty on all LED products & 1-year warranty on battery-operated products, unless specified. LED warranty void without surge protection. Refer to page 128.

MEANWELL POWER SUPPLIES & DRIVERS

3 Year Warranty



Code	Output			Input Voltage	Size (mm)
	Power	DC Voltage	Current		
Power Supplies - LRS Series IP30					
LRS-35-12	35W	12V	3A	AC85-264V	99 x 82 x 30
LRS-35-24		24V	1.5A		
LRS-50-12	50W	12V	4.2A	AC85-264V	99 x 82 x 30
LRS-50-24		24V	2.2A		
LRS-75-12	75W	12V	6A	AC85-264V	99 x 97 x 30
LRS-75-24		24V	3.2A		
LRS-100-12	100W	12V	8.5A	AC85-264V	129 x 97 x 30
LRS-100-24		24V	4.5A		
LRS-150-12	150W	12V	12.5A	85-132VAC/ 170-264VAC	159 x 97 x 30
LRS-150-24		24V	6.5A		
LRS-200-12	200W	12V	17A	AC180-264V	215 x 115 x 30
LRS-200-24		24V	8.8A		
LRS-350-12	350W	12V	29A	AC180-264V	215 x 115 x 30
LRS-350-24		24V	14.6A		

- Can be used in Class 1, Division 2 hazardous luminaires
- 1 - 10V or PWM Signal or resistance dimming
- Output Volts: 30 - 40V
- Output Volts Regulation: 0.5%

5 Year Warranty



Power Supplies - HLG Series - Built-in Active PFC Function IP67

HLG-40H-36A	40W	36V	1.12A	AC90-305V	171 x 61.5 x 368
HLG-60H-36A	60W	36V	1.7A	AC90-305V	171 x 61.5 x 368
HLG-80H-36A	80W	36V	2.3A	AC90-305V	195 x 61.5 x 368
HLG-100H-36A	100W	36V	2.65A	AC90-305V	220 x 68 x 38.8
HLG-120H-36A	120W	36V	3.4A	AC90-305V	220 x 68 x 38.8
HLG-150H-36A	150W	36V	4.2A	AC90-305V	228 x 68 x 38.8
HLG-185H-36A	185W	36V	5.2A	AC90-305V	228 x 68 x 38.8
HLG-200H-36A	200W	36V	5.5A	AC90-305V	244 x 68 x 39
HLG-240H-36A	240W	36V	6.7A	AC90-305V	244.2 x 68 x 38.8
HLG-320H-36A	320W	36V	8.9A	AC90-305V	252 x 90 x 43.8

2 Year Warranty



Power Supplies - APV Series IP30

APV-12-12	12W	12V	1A	AC90-264V	77 x 40 x 29
APV-12-24		24V	0.5A		
APV-16-12	16W	12V	1.25A	AC90-264V	77 x 40 x 29
APV-16-24		24V	0.67A		
APV-25-12	25W	12V	2.1A	AC90-264V	84 x 57 x 295
APV-25-24		24V	1.05A		
APV-35-12	35W	12V	3A	AC90-264V	84 x 57 x 295
APV-35-24		24V	1.5A		

2 Year Warranty



Power Supplies - LPV Series IP67

LPV-20-12	20W	12V	1.67A	AC90-264V	118 x 35 x 26
LPV-20-24		24V	0.84A		
LPV-35-24	35W	24V	1.5A	AC90-264V	148 x 40 x 30
LPV-60-12	60W	12V	5A	AC90-264V	162.5 x 42.5 x 32
LPV-60-24		24V	2.5A		
LPV-100-12	100W	12V	8.5A	AC90-264V	190 x 52 x 37
LPV-100-24		24V	4.2A		
LPV-150-12	150W	12V	10A	AC180-305V	191 x 63 x 37.5
LPV-150-24		24V	6.3A		

LED CONSTANT VOLTAGE DRIVERS - VS

VS LIGHTING SOLUTIONS



Easyline - 12V - IP20 | Electronic short circuit protection | Overload protection | Protection against "No-Load" operation | Protection class II

Code	Watts	Current (A)	Output Volts	Dimensions (mm)
186621	60W	5	12V	180 x 45 x 19
186623	100W	8.40	12V	300 x 40 x 30

Comfort Line - 24V - IP20 | Electronic short circuit protection | Overload protection | Protection against "No-Load" operation | Protection class II

Code	Watts	Current (A)	Output Volts	Dimensions (mm)
186625	60W	2.5	24V	153 x 41 x 32
186627	120W	5	24V	300 x 40 x 30

Easyline - 12V - IP67 | Electronic short circuit protection | Overload protection | Protection against "No-Load" operation | Protection class II

Code	Watts	Current (A)	Output Volts	Dimensions (mm)
186629	75W	6.25	12V	155 x 50 x 32
186630	100W	8.34	12V	206 x 69 x 37
186631	150W	12.5	12V	206 x 69 x 37



Comfort Line - 24V - IP67 | Electronic short circuit protection | Overload protection | Protection against "No-Load" operation | Protection class II

Code	Watts	Current (A)	Output Volts	Dimensions (mm)
186432	75W	3.125	24V	180 x 42 x 34
186433	100W	4.2	24V	206 x 68 x 37
186434	150W	6.25	24V	206 x 68 x 37

LED DRIVERS

IP68 - Supply Volts 170 - 250VAC | Short Circuit protection | Overload protection



PSU-2.5/12

Code	Watts	Current (A)	Output Volts	Dimensions (mm)
PSU-1.5/12	20W	1.5	12VDC	162 x 27 x 21
PSU-2.5/12	30W	2.5	12VDC	177 x 31 x 21
PSU-5/12	60W	5	12VDC	133 x 62 x 38
PSU-8.3/12	100W	8.3	12VDC	205 x 132 x 65
PSU-12.5/12	150W	12.5	12VDC	205 x 117 x 58

LED Drivers - Constant Voltage



APT-MR16-12V



APT-AR111-15V



LHV100W24

Code	Volts In	Volts Out	Current Out	Power	Size (mm)	For use with
APT-MR16-12V	90-264VAC	12VDC	500mA	6W	51 x 42 x 23	-
APT-AR111-15V	90-264VAC	15VDC	800mA	12W	60 x 20 x 32	LEDAR111
LHV100W24	220-240VAC	24VDC	4.2A	100W	180 x 88 x 36	-

LED DIMMABLE DRIVER IP65

Constant Voltage



Code	LEA-103C	LEA-105A	LEA-108A	LEA-112-A	LEA-115A
Input Voltage	100-277VAC				
Constant Voltage	12VDC				
Output Power	36W	60W	96W	150W	200W
Protection	Short Circuit, Overload, Over Heat				
External Dimming Control	0-100% (1-10V)				
Size (mm)	260 x 29 x 20	178 x 68 x 53	240 x 68 x 53	256 x 80 x 53	256 x 80 x 53

2-year warranty on all LED products & 1-year warranty on battery-operated products, unless specified. LED warranty void without surge protection. Refer to page 128.

NEW

CONSTANT CURRENT DRIVERS - TCI IP20



Professional Dali 38 with Programmable Current (Dimmable) - Multi-power driver with dip switch for the selection of the output current | Dali 2 dimming (Compatible with standard Dali interfaces) and push switch dimming, 0/1% - 100%

Code	Max Output	Current Output DC	Voltage Output DC	Dimensions
127490	16-38W	300-1050mA	10-54V	146.5 x 44 x 30mm

LED CONSTANT CURRENT DRIVERS - VS IP20



Easy Line LED Driver - Electronic Short-Circuit Protection | Over-Load Protection | Protection Against "No Load" Operation | Protection Class II | Secondary Side Switching of LED Modules is not allowed

Code	Max Output	Current Output DC	Voltage Output DC	Dimensions (mm)
VS186341	12.6W	350mA	8.4 - 36V	123 x 45 x 19
VS186431	20W	350mA	18 - 57V	123 x 45 x 19
VS186350	20.3W	700mA	8 - 29V	123 x 45 x 19
VS186502	47W	1050mA	27 - 45V	171 x 41 x 32



Easy Line LED Driver - Dimmable - Dimmable with Phase Cutting Trailing Edge Dimmer | Minimum dimmer load has to be observed (150mA - 700mA / Max 6 - 36W) | Electronic Short-Circuit Protection | Over-Load Protection | Protection Against "No Load" Operation | Protection Class II

Code	Max Output	Current Output DC	Voltage Output DC	Dimensions (mm)
186710	10W	250mA	20-40V	115 x 45 x 25
186449	12W	250mA	27 - 48V	123 x 45 x 19
186416	25W	700mA	22 - 36V	153 x 41 x 32
186451	36W	700mA	32 - 52V	171 x 41 x 32



Easy Line LED Driver - With Selectable Current - The required current output can be chosen by selecting the respective pin at the output terminal | Temporary Electronic Short-Circuit Protection | Protection Against "No Load" Operation | Protection Class II | Secondary Side Switching of LED Modules is not allowed

Code	Max Output	Current Output DC	Voltage Output DC	Dimensions (mm)
186463	10W	250mA	17 -40V	103 x 67 x 31
	14W	350mA		
	20W	500mA		

NEW



Easy Line LED Driver - DIP Switch - Selectable current output by Dip Switch | Over load protection | Typical Applications: Shop Lighting, Office Lighting, Residential Lighting and Downlights

Code	Max Output	Current Output DC	Voltage Output DC	Dimensions (mm)
187116	6.3W	150mA	10-42V	97 x 43 x 30
	8.4W	200mA		
	10.5W	250mA		
	12.6W	300mA		
	14.7W	350mA		
	16.8W	400mA		
	18.9W	450mA		
187117	21W	500mA	28-40V	97 x 43 x 26
	24W	600mA		
	26W	650mA		
	28W	700mA		
187119	32W	800mA	28-40V	97 x 43 x 26
	34W	850mA		
	36W	900mA		
	38W	950mA		
	42W	1050mA		

Comfort Line LED Driver - With Selectable Current - The required current output can be chosen by selecting the respective pin at the output terminal | Electronic Short-Circuit Protection | Over-Load Protection | Protection Against "No Load" Operation | Protection Class II.



Code	Max Output	Current Output DC	Voltage Output DC	Dimensions (mm)
186444	40W	350mA	57 - 114V	359 x 30 x 21
		500mA	40 - 80V	
		700mA	28 - 57V	
186443	79W	350mA	120 - 225V	359 x 30 x 21
		500mA	80 - 170V	
		700mA	60 - 120V	

LED CONSTANT CURRENT DRIVERS - VS IP20

Primeline LED Driver - With Programmable Current (Dimmable) - The output current can be freely adjusted in 1mA steps between 350mA and 700mA (Factory Setting 350mA) | Dimming function is achieved by applying a pwm signal to the nominal current. Dimming Range: 1 to 100%. If no dimming interface is connected, brightness will stay at 100% | Dali and push button dimming is possible | Secondary side switching of LED modules is allowed (Hot wiring).



Code	Max Output	Current Output DC Programmable	Voltage Output DC	Dimensions
186465	24W	350 - 700mA	14 - 34V	104 x 67 x 31
186572	37W	350 - 700mA	30 - 53V	125 x 79 x 33
NEW 186578	84W	350 - 700mA	60 - 220V	359 x 30 x 21

LED Set - The Output Current can be Freely Adjusted Between 275mA and 700mA by Using a Resistor | Dimming function is achieved by applying a pwm signal to the nominal current. Dimming Range: 1 to 100%. | Dali and push button dimming is possible.



186565	42W	275 - 700mA (350mA Factory Set)	30 - 153V	359 x 30 x 21
--------	-----	------------------------------------	-----------	---------------

10W VOLTAGE ELECTRONIC TRANSFORMERS

Electronic Transformers for Low Voltage Lamps - Dimmable



T-35ET



GF-60/105/150

Code	Lamp Watts	V-in	V-out	Size (mm)	Ta	Tc	Hz-in	Hz-out
T-35ET	35W	230-240V	11.2	90 x 40 x 18	-25 – +50°C	50°C	50-60	34kHz
GF-105*	35-105W	230-240V	11.4	146 x 44 x 23	-25 – +40°C	75°C	50-60	34kHz
GF-150*	35-150W	230-240V	11.4	166 x 41 x 31	-25 – +40°C	75°C	50-60	34kHz
ET210	50-210W	230-240V	11.5	200 x 43 x 39	-20 – +50°C	70°C	50-60	34kHz

*Conformity: EN61046; EN55015; EN61547; EN61000 & EN50082-1. Surge withstanding capability is 3.75kV.

DIMMABLE ELECTRONIC TRANSFORMERS

Zero Minimum Load

Indoor IP20

Outdoor IP56



Code	ETZ-60	ETZ-105	ETZ-210	ETW-60	ETW-105	ETW-210
Input Voltage	230VAC±10%					
Nominal Input Current	0.27A	0.46A	0.93A	0.23A	0.46A	0.93A
Voltage Output	11.5VAC					
Power Range	0-60W	0-105W	0-210W	0-60W	0-105W	0-210W
Current Output	5.2A	9.1A	18.2A	5.2A	9.1A	18.2A
Size (mm)	95 x 41 x 27H	108 x 44 x 33H	167 x 52 x 38H	73 x 41 x 27H	81 x 44 x 33H	167 x 52 x 38H

LOW VOLTAGE ELECTRONIC TRANSFORMERS IP20



VS186173



VS186077



VS186098



Independant Electronic Converters - Liteline - For low voltage halogen incandescent lamps 12V | Protection against "no load" operation | protection against short-circuit: Electronic switch-off with automatic restart | Suitable for installation in furniture and on combustible surfaces | Dimming: Optional with phase-cutting leading-edge or phase-cutting trailing-edge dimmer

Code	Wattage	Primary	Output	Size (mm)
VS186173	10-60W	220-240V	12VAC	22 x 36 x 103
VS186077	20-105W	230-240V	12VAC	28 x 37 x 128

LOW VOLTAGE TRANSFORMERS

Iron Core Transformers 230V/12VAC complete with fuse. For Halogen Lamps.



Code	Amps @12V	No of Lamps per Transformer		
		50W	35W	20W
L-50VA	4.16A	1	1	2
L-100VA	8.33A	2	2	5
L-150VA	12.5A	3	4	7
L-200VA	16.6A	4	5	10
L-250VA	20.8A	5	7	12
L-300VA	25A	6	8	15
L-350VA	29.16A	7	10	17
L-400VA	33.33A	8	11	20
L-500VA	41.66A	10	14	25

Iron Core Transformers - 230/12VAC | Slim type



Code	VA	Amps	Size (mm) L x W x H
TRF-105	105	8.75A	239 x 43 x 35

Approved to EN61558-1-7 certified by TÜV

ELECTRONIC BALLASTS

Standard Ballasts

T8 Rapid Start



Single Tube Code T8	Lamp Watts	Size (mm) L x H x W	Double Tube Code T8	Lamp Watts	Size (mm) L x H x W
---------------------	------------	------------------------	---------------------	------------	------------------------

220-240V Electronic Ballast for T8 lamp rapid start non-dimmable. EEI - A2.

*L-18E	18W	225 x 28 x 30	*L2-18E	2 x 18W	225 x 28 x 30
*L-30E	30W	225 x 28 x 30	*L2-30E	2 x 30W	225 x 28 x 30
*L-36E	36W	225 x 28 x 30	*L2-36E	2 x 36W	225 x 28 x 30
*L-58E	58W	225 x 28 x 30	*EBT-265	2 x 58W	225 x 28 x 30

* For 110V add voltage to end of code eg: L-18E/110VAC

T8 Pre-Heat

T8 3 Lamp			T8 3 or 4 Lamp		
EBT-336	3 x 36W	365 x 28 x 38	L4-18E	4 x 18W	305 x 28 x 38

180-264V Compact Ballast for T8 Lamp Pre-heat Start Non-Dimmable

IC-36E	36W	365 x 28 x 30	IC2-18E	2 x 18W	365 x 28 x 30
IC-58E	58W	365 x 28 x 30	IC2-36E	2 x 36W	425 x 28 x 36

VS COMPONENTS

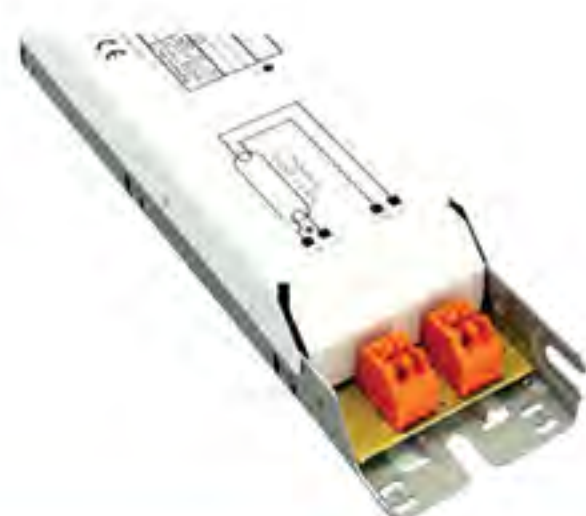

Electronic T8 Ballast - Warm Start - 220-240VAC

Code	Wattage	Type	Base	Size (mm)
188704	18W / 36W	T8	G13	230 x 41 x 28
188705	2 x 18W / 36W	T8	G13	230 x 41 x 28
188706	1 x 58W	T8	G13	230 x 41 x 28
188707	2 x 58W	T8	G13	230 x 41 x 28
188744	3 x 18W / 4 x 18W	T8	G13	230 x 41 x 28



Electronic T5 Ballast - Warm Start - 220-240VAC

188921	1 x 14W / 1 x 21W / 1 x 28W / 1 x 35W	T5	G5	230 x 30 x 21
188921	2 x 14W / 2 x 21W / 2 x 28W / 2 x 35W	T5	G5	230 x 30 x 21
188438	3 x 14W / 4 x 14W	T5	G5	230 x 41 x 28
188142	1 x 54W	T5	G5	359 x 30 x 21
188618	2 x 54W	T5	G5	359 x 30 x 21
188144	1 x 80W	T5	G5	359 x 30 x 21
188619	2 x 80W	T5	G5	359 x 30 x 21

VS COMPONENTS



Electronic Ballast for multiple wattage CFL Lamps - 220 / 240VAC

Code	Wattage	Type	Base	Size (mm)
188700	18-40W	TC-DEL/TEL	2G10/2G11 2G x 13 G24q-3/Gx24q-3	103 x 67 x 31

HPS / Metal Halide ballasts - 230 / 240VAC



Code	Wattage	Amps	Size LxBxH	Capacitor Required	Lamp Type
161367	35W	0.53A	108 x 66 x 53	6µF	HPS / MH
161379	50W	0.76A	108 x 66 x 53	8µF	HPS
571022	70W	0.98A	108 x 66 x 53	12µF	HPS / MH
570964	100W	1.20A	112 x 86 x 36	12µF	HPS / MH
571013	150W	1.8A	145 x 69 x 53	20µF	HPS / MH
504109	250W	3.00A	108 x 66 x 53	32µF	HPS / MH
178771	250W	3.00A	133 x 102 x 93	32µF	HPS / MH
571054	400W	4.45A	148 x 135 x 62	45µF	HPS / MH
533484	600W	6.20A	173 x 102 x 93	55µF	HPS
528548	1000W	10.3 / 9.5A	203 x 102 x 92	100 / 85µF	HPS / MH
NEW 571046	1000W	10.3 / 9.5A	248 x 235 x 160	100 / 85µF	HPS / MH
554304	2000W	8.8A	160 x 150 x 128	37µF	MH
554306	2000W	10.3A	160 x 150 x 128	60µF	MH

Mercury Vapour / Metal Halide Ballast - 230VAC



Code	Wattage	Amps	Size LxBxH	Capacitor Required	Lamp Type
167304	80W	0.80A	108 x 66 x 53	8µF	MV
570968	80W	0.80A	112 x 69 x 53	8µF	MV
570969	125W	1.15A	112 x 86 x 36	10µF	MV
167367	250W	2.13A	145 x 66 x 53	18µF	MV / MH
570972	250W	2.13A	145 x 120 x 64	18µF	MV / MH
570971	400W	3.25A	180 x 69 x 53	25µF	MV / MH
528761	1000W	7.50A	173 x 102 x 92	60µF	MV
NEW 571255	1000W	7.50A	173 x 104 x 91	60µF	MV / MH

Ignitors



35-400W



1000-2000W

Code	Wattage	Size LxBxH	Type	Pick V
140597	35-400W	78 x 34 x 27mm	Superimposed 3 Wire	4-5kV
140430	250-1000W	Ø50 x 80mm	Superimposed 3 Wire	4-5kV
140497	2000W	Ø50 x 98mm	Superimposed 3 Wire	4-5kV

Standard Magnetic Ballast - 230VAC



Code	Output Wattage	Type	Base	Size (mm)
530941	18W	TC-F / TC-L	2G10 / 2G11 / 2G13	150 x 41 x 28
508183	18W / 20W	T8 / T12	G13	
529029	36W	TC-F / TC-L	2G10 / 2G11	150 x 41 x 28
	36W / 40W	T8 / T12	G13	
508186	58W	T-U	2G13	190 x 41 x 28
	58W / 65W	T8 / T12	G13	

NEW

TCI COMPONENTS



Electronic T8 Ballast - Preheat - 220-240VAC / EEI = A2

Code	Wattage	Type	Base	Size (mm)
TCIBLT8118	1 x 18W	T8	G13	280 x 30 x 29
TCIBLT8136	1 x 36W	T8	G13	280 x 30 x 29
TCIBLT8158	1 x 58W	T8	G13	280 x 30 x 29
TCIBLT8218	2 x 18W	T8	G13	280 x 30 x 29
TCIBLT8236	2 x 36W	T8	G13	280 x 30 x 29
TCIBLT8258	2 x 58W	T8	G13	280 x 30 x 29



Electronic T5 - Preheat - 220-240VAC / EEI = A2

TCIBLT51X14	1 x 14W	T5	G5	280 x 265 x 29
TCIBLT52X14	2 x 14W	T5	G5	285 x 265 x 29



Electronic CFL Ballast - Preheat - 220-240VAC / EEI = A2

Code	Wattage	Type	Base	Size (mm)
BLC-116	1 x 5-7-9-11	TC-S/E	2G7	80 x 41 x 18
	1 x 10	TC-D/E	G24q-1	
	1 x 10-16	TC-DD	Gr10q	
BLC-121	1 x 13-18	TC-D/E	G24q-1/2	80 x 41 x 18
	1 x 13-18	TC-T/E	Gx24q-1/2	
BLC-124	1 x 18-24	TC-L	2G11	80 x 41 x 18
	1 x 18-24	TC-F	2G10	
	1 x 22	T-R5	2Gx13	
BLC-126	1 x 24	TC-L	2G11	80 x 41 x 18
	1 x 24	TC-F	2G10	
	1 x 26	TC-D/E	G24q-3	
	1 x 26	TC-T/E	Gx24q-3	
	1 x 22	T-R5	2Gx13	

MAGNETIC BALLASTS



Ballast for Mercury Vapour Lamps 230V 50Hz

Code	Watts	Amps	Size (mm) L x W x H	Capacitor Required
Q80-612.2	80W	0.8A	112 x 66 x 53	8 μ F
Q125-613.2	125W	1.15A	112 x 66 x 53	12 μ F

For 250W & 400W, See **M250.2** and **M400.2** below.



High Pressure Sodium (HPS) and Metal Halide (MH) Lamps 230V 50Hz

Code	Watts	Amps	Size (mm) L x W x H	*Capacitor Required	For Lamp Type
SM70.2	70	1A	112 x 66 x 53	12 μ F	HPS/MH
SM100.2	100	1.2A	144 x 66 x 53	12 μ F	HPS
SM250.2	250	3.0A	180 x 66 x 53	32 μ F	HPS/MH
SM400.2	400	4.6A	185 x 75 x 65	50 μ F	HPS/MH

For Metal Halide and Mercury Vapour Lamps

M250.2	250	2.13A	144 x 66 x 53	18 μ F	MH/MV
M400.2	400	3.4A/3.25A	180 x 66 x 53	30 μ F	MH/MV
B1000S	1000	10.3A	203 x 102 x 92	100 μ F	HPS

2-year warranty on all LED products & 1-year warranty on battery-operated products, unless specified.
LED warranty void without surge protection. Refer to page 128.

MAGNETIC BALLASTS

Ballast for Tubular or Compact Fluorescent Lamps 230V 50Hz.



DEB-G182



CLB318



CBP

Code	Lamp	Watts	Size (mm) L x W x H
FL20	T8	18-26W	155 x 41 x 28
FL40	T8	1x36W or 2x18W	155 x 41 x 28
FL65	T8	58-65W	195 x 41 x 28
FC9	PL	7/9/11W	100 x 41 x 26
CB-508	PL	13/18W	95 x 41 x 28
CB800-26	PL	26W	155 x 41 x 28
CB800-42	PL	42W	155 x 41 x 28

Electronic Ballast Lamp Holder

DEB-G182	PLC, PLCE (G24q, GX24q)	9-18W	φ40 x 50
----------	-------------------------	-------	----------

Ballast for PL-Lamp c/w Holder

CLB318	PLC		155 x 41 x 18
--------	-----	--	---------------

Control (Plastic) Box for PL-Lamp

Code Magnetic	Watts	Size (mm)	Code Electronic
CBP-213	2 x 13W c/w 3.25MF cap	254 x 52 x 100	EBP-214
CBP-218	2 x 18W c/w 4MF cap	254 x 52 x 100	EBP-218
CBP-226	2 x 26W c/w 8MF cap	254 x 52 x 100	EBP-226

IGNITOR / STARTERS

Ignitors for High Pressure Sodium and Metal Halide Lamps 220-240V 50/60Hz

Code	Type	Watts	Pick V.	Amps	°C	Size (mm) L x Ø
CD-7	Superimposed 3 Wire	35-400	3-4.5kV	1.8	105	90 x 35
CD-10	Superimposed 3 Wire	600-1000	3-4.5kV	1.8	105	90 x 35



CD-7

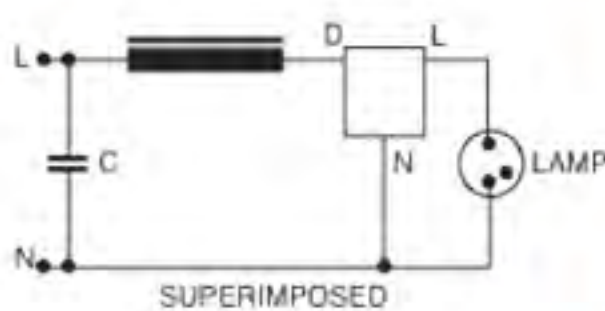

UR150.20

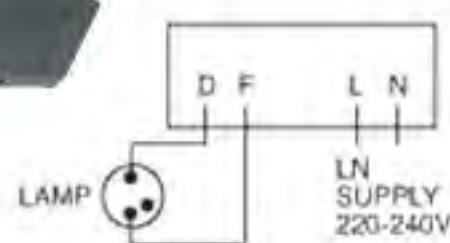

Enclosed Control Gear C/W Ignitor, Capacitor and Ballast for HPS & MH

Code	Watts	Amps	Size (mm)
UR70.20	70	1	245 x 120 x 70
UR100.20	100	1.2	245 x 120 x 70
UR150.20	150	1.8	245 x 120 x 70
NB150GB (for metal halide only)	150	1.8	245 x 120 x 70

Report No.

EMI/2316/Y1022A & B

2330/YE1457A & B

FST2 & 4



Linear Fluorescent Lamp Starters

Code	Wattage	Voltage	Description
FST2	4-25W	220-240V	To be used with 2 x 18W Tube, single 40W ballast luminaire
FST4	4-85W	220-240V	For use with 3ft, 4ft and 5ft tubes

EMERGENCY KIT WITH STANDBY FEATURE

Input Voltage: 230VAC



The Emergency Control unit has a standby inhibit function to conserve battery power during power failure I Maintained and Non-Maintained

Emergency Kit with Standby Power - Battery to be Ordered Separately

Code	Fluorecent Lamp Wattage	Emergency Duration	Dimensions (mm)
TLX-STBY	6 - 80W	20% 1hr	247 x 45 x 35

Battery - Nickle-Cadmium

Code	Battery Capacity	Voltage	Dimensions (mm)
TLX-BATT	5 x 2Ah	6V	110 x 46 x 26

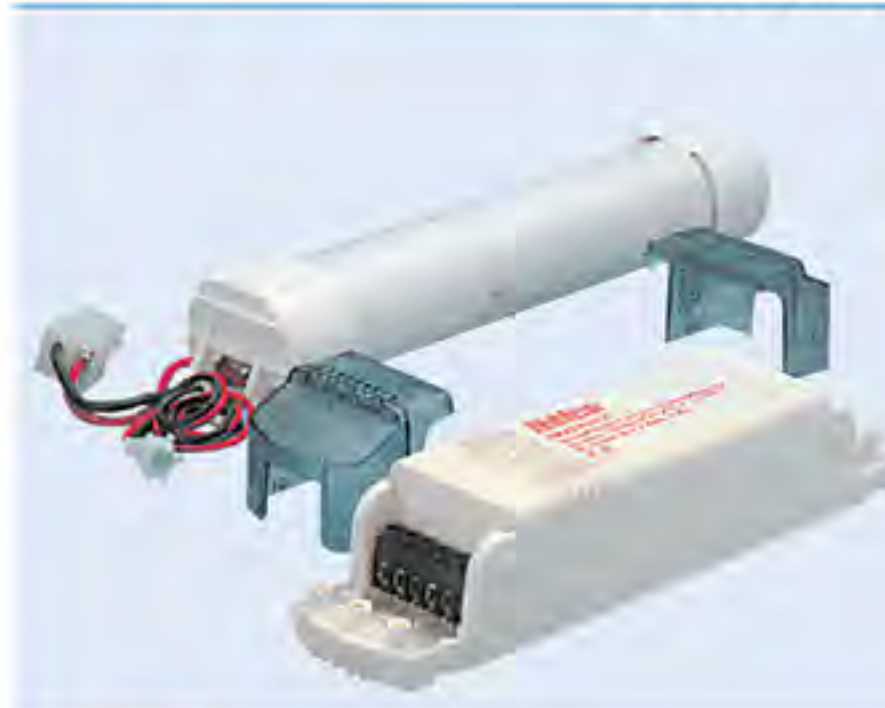

220-240V Electronic Emergency Inverters for use with Electromagnetic and Electronic Ballasts

Code		Lamp		Size L x W x H	Spare Battery	Battery		Output Lumen
1H	3H	Type	Watts			Volts	Ah	
1A186018	-	T8/T5/G23	18-65W	190x40x35	5KRH23/43	6V	4	38%-10%
-	RP0701	G24/Gx24/2G11	18-65W	175x41x35	802027	3.6V	4	38%-10%

*Automatically cycles the battery every 4 weeks. Includes battery and LED battery indicator. Provides power to all fluorescent lamps during power failure to provide a suitable level of illumination for evacuation. Can be used for maintained and non-maintained illumination conversions.



Emergency Lighting Modules for TC and T Lamps - 6 to 80W with Self-Diagnosis function I

Battery charging Time 24h

Code		Lamp		Size L x W	NiCd Battery	Battery		Output Lumens
1H	3H	TYPE	Watts			Volts	Ah	
188792	-	TC&T	6-80W	210 x 31 x 21	188823	4.8V	1.8Ah	3.7-43%
-	188793	TC&T	6-80W	210 x 31 x 21	188824	4.8V	4.5Ah	3.7-43%

Accessories

Code	Description
188827	Holder for 1H Rechargeable Batteries (order 2pcs for a set)
188828	Holder for 3H Rechargeable Batteries (order 2pcs for a set)



220-240V Combined Electronic Ballast and Emergency Inverter

Code		Lamp		Output Lumen	Size L x W x H	Spare Battery					
1H	3H	Type	Watts			1H	V	Ah	3H	V	Ah
DT-18E-1H	DT-18E-3H	T8	18W	38%	288x30x40	3KRH23/43	3.6	1.8	3KRH33/62	3.6	4
IT-36E-1H	IT-36E-3H	T8	36W	18%	425x30x38	4KRH23/43	4.8	1.8	4KRH33/62	4.8	4
IT-58E-1H	IT-58E-3H	T8	58W	10%	425x30x38	5KRH23/43	6	1.8	5KRH33/62	6	4
IT-54E-1H	IT-54E-3H	T5	54W	10%	425x30x38	5KRH23/43	6	1.8	5KRH33/62	6	4



220-240V Emergency Inverters for PL 26W Lamps

Code	Description
HT-PL26W	3 hour emergency duration kit for PL26W lamp (single lamp)

LED EMERGENCY DRIVER



Universal LED Driver

Input Voltage: 85-265V I Battery Cycle Times ≥ 500 I To be used with External LED Driver

Code	Emergency Luminous Flux	LED Lamp Power	Output	Battery	Emergency	Size (mm)
FAT-LED-F1D	2-4W	3-20W	To driver	18650 Li-ion 3.7V; 2200mAh	3 hours	68 x 38 x 20
FAT-LED-F1A	4W Fixed	3-40W	To driver	18650 Li-ion 3.7V; 2400mAh	≥ 2 hours	110 x 55 x 21
FAT-LED-E50W	100%	3-50W	230VAC	18650 Li-ion 18.5V; 5200mAh	≥ 90 min	230 x 105 x 50
FAT-LED-E100W	100%	50-100W	230VAC	18650 Li-ion 18.5V; 7200mAh	≥ 90 min	310 x 105 x 50

Emergency Inverter

Input Voltage: 230VAC I Maintained & Non-Maintained I Not limited to a specific number of cells for a given inverter I Battery not included I Compatible with **IBG-LED-60W** & **IBG-LED-100W** (page 41)

Code	Nominal Voltage	Nominal Current	Lamp Power	Battery	Emergency Time	Size (mm)
ECLAT-39410	24VDC	2950mA	60-70W	18V (3x6V 4.5Ah)	1hr 100%	31 x 40 x 280
ECLAT-39482	24VDC	2500mA	90-120W	24V (4x6V 4.5Ah)	1hr 100%	31 x 40 x 280

2-year warranty on all LED products & 1-year warranty on battery-operated products, unless specified. LED warranty void without surge protection. Refer to page 128.

EMERGENCY ILLUMINATION



LED Slim Light - Maintained / Non-Maintained (Jumper Selectable) - **IP20** | 230 VAC

Codes	Consumption	Battery Ni-Cd	Duration	Lamp	Light Output	Weight
GR-8/12LED	3VA	3.6V / 0.6Ah	1.5hrs	12 LED's	35lm / 85lm	430g
GR-9/12LED	3.5VA	3.6V / 1Ah	3hrs	12 LED's	32lm / 85lm	460g

• Size (mm): 246(L) x 76(W) x 45(D)

Additional Self-Adhesive Legends - To be ordered separately

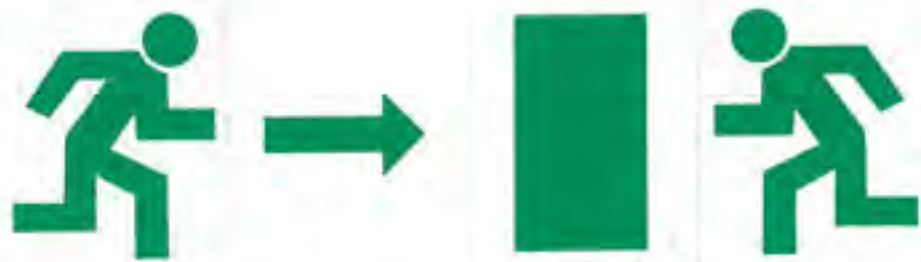

Self-adhesive legends included in pack. Suitable for each direction.

S-00800/S65L

S-00800/S65R

S-00800/S65D



Professional Light

Professional Light - Emergency Luminaires 230V IP20

Code	Consumption	Battery Ni-Cd	Duration	Lamp	Light Output	Weight
Fluorescent - Non-Maintained						
GR-110	3VA	2.4V / 1.5Ah	90min	8W	85lm	770g
GR-112	3VA	2.4V / 3Ah	3hrs	8W	85lm	870g
GR112-2	3VA	2.4V / 3Ah	3hrs	2 x 8W	85lm	870g

Fluorescent - Maintained

GR-115	23VA	2.4V / 1.5Ah	90min	8W	315 / 85lm	810g
GR-116	24VA	2.4V / 3Ah	3hrs	8W	315 / 85lm	920g

LED - Maintained & Non-Maintained (Jumper Selectable)

GR-110-LED	3VA	3.6V / 600mAh	90min	3W LED	105lm	590g
GR-112-LED	3VA	3.6V / 1.5Ah	3hrs	3W LED	105lm	670g

- c/w Easy Base - for easy installation
- Spare Lamp **FLT5-8**

Accessories

Code	Description
A-1013	Recess mounting base for wall or suspended ceiling installation



LED



A-1013

Additional Self-Adhesive Legends - To be ordered separately



Self-adhesive legends included in pack. Suitable for each direction.

S-11100/S65L

S-11100/S65R

S-11100/S65D



Double Easy Light - Emergency Luminaires 230V IP42

Code	Consumption	Battery Ni-Cd	Duration	Lamp	Light Output	Weight
Fluorescent - Non-Maintained						
GR-380	3VA	2.4V / 1.5Ah	90min	8W	85lm	900g
GR-382	4VA	2.4V / 3Ah	3hrs	8W	85lm	1000g

LED - Non-Maintained

GR-391/L	3VA	3.6V / 1.5Ah	1.5hrs	3W	220lm	900g
GR-393/L	3VA	3.6V / 3Ah	3hrs	4.3W	220lm	1000g

- Dimensions: 350(L) x 134(W) x 60(H)mm
- Can be mounted onto the ceiling or wall, using special mounting accessories, which are included.
- Spare Lamp **FLT5-8**

Additional Self-Adhesive Legends - To be ordered separately

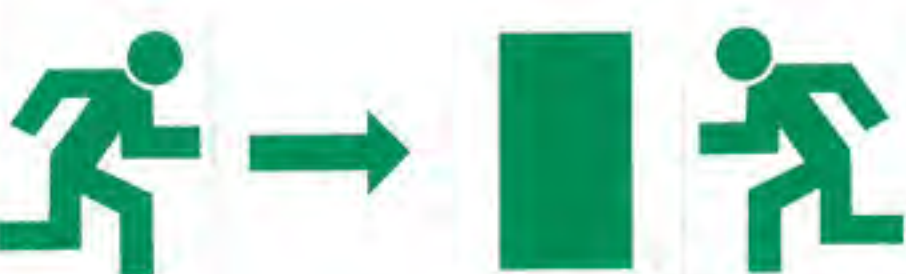

Self-adhesive legends included in pack. Suitable for each direction.

S-31100/S65L

S-31100/S65R

S-31100/S65D

EMERGENCY ILLUMINATION



LED Weather Light - Emergency Luminaires - Non-Maintained - IP65 | 230V

Codes	Consumption	Battery Ni-Cd	Duration	Lamp	Light Output	Weight
GR-1935/15L	3VA	3.6V / 600mAh	1.5hrs	2.5W	105lm	1010g
GR-1936/15L	4VA	3.6V / 1.5Ah	3hrs	2.5W	105lm	1080g

• Dimensions: 363(L) x 145(W) x 73(H)mm

Additional Self-Adhesive Legends - To be ordered separately



S-93593/S65L



S-93593/S65R



S-93593/S65D

Eco Light - Emergency Luminaires - 230V IP42

Codes	Consumption	Battery Ni-Cd	Duration	Lamp	Light Output	Weight
LED - Maintained Edge Illumination with Green LEDs & Transparent Background						
MLD28/G	7.5VA	3.6/1Ah	3hrs	8 LEDs	18/18lm	500g
MLD34/G	8VA	3.6/1Ah	3hrs	11 LEDs	18/22lm	800g
MLD44/G	8VA	3.6/1Ah	3hrs	13 LEDs	18/22lm	1200g

Codes	Consumption	Battery Ni-Cd	Duration	Lamp	Light Output	Weight
LED - Maintained Edge Illumination with White LEDs & Green Background						
MLD28/W	7.5VA	3.6/1Ah	3hrs	8 LEDs	45/45lm	520g
MLD34/W	8VA	3.6/1Ah	3hrs	11 LEDs	45/55lm	860g
MLD44/W	8VA	3.6/1Ah	3hrs	13 LEDs	45/55lm	1250g

Dimensions

MLD28	280(L) x 100(H) x 75(W)mm
MLD34	340(L) x 170(H) x 75(W)mm
MLD44	440(L) x 220(H) x 75(W)mm

Accessories included:



• Includes 2 pairs of special PVC Overlays



Accessories

A-1022	Rigid arms for ceiling installation; 20cm distance
A-1025	Rigid arms for ceiling installation; 40cm distance
A-1026	Rigid arms for ceiling installation; 60cm distance
A-1027	Chains for ceiling installation; 50cm
A-1018	Recessed mounting base for MLD28
A-1020	Recessed mounting base for MLD34
A-1021	Recessed mounting base for MLD44



Hanging Installation using the special mounting sets.

- A-1022 - suitable for 20cm distance
- A-1025 - suitable for 40cm distance
- A-1026 - suitable for 60cm distance



Recessed Mounted Installation on suspended ceiling using the base type A-1018, A-1020, A-1021

HIGHBAY EMERGENCY BACKUP KIT

Input Voltage: 100-277VAC | Compatible with highbay: 0-200W | Highbay must have 0/1-10V Input | Highbay will reduce power to 30% when emergency is active | Protection: Over Voltage, Short Circuit, Overload & Open Circuit | Self-diagnostics: The unit will automatically conduct monthly 30 minute and manual 90 minute test

Code	Output Voltage	Output Power	Highbay	Emergency Time	Dimensions
HB-EMG-40-90M	170VDC	40W	0-150W	90min	Ø142 x 239
HB-EMG-60-90M	170VDC	60W	200W	90min	Ø142 x 239

Accessories

Code	Description
HB-EMG-REMOTE	Wireless Remote Control for Emergency Test Control

NEW



Highbay to be ordered separately

EMERGENCY ILLUMINATION



LED Non Maintained - Ceiling Mounted IP42 - Input Voltage: 230VAC | Deep Discharge and Overcharge Protection | 24hrs Charge Time | Each device must be permanently connected to mains power supply. In normal operation the battery is charging. In case of a mains power failure the device will light the illumination LED automatically in emergency mode. When power is restored the device turns to normal operation

Codes	Wattage	Battery Ni-CD	Duration	Lamp	Lumens	Weight	Size (mm)
GR-471	24W	36V/1.2Ah	1.5h	2W	160lm	470g	195 x 195 x 60



LED Recessed Emergency Downlight IP20 - Input Voltage 230VAC | Battery: 3.7V 3Ah 18650 | Charge Time 12h | Built-in Test Function | 160° Beam Angle | Non-Maintained | Applications: Hotels, Restaurants, Shopping Malls, Offices, & Public Places to provide Illumination for Evacuation

Code	Wattage	Lumens	Duration	Size (mm)
JH-396B-3W-*	3W	180lm	≥3hrs	Ø60 x 26.5mm

*Add colour temp. to code: ○ WW (3000K), ○ CW (4200K)



LED Downlight Emergency Kit - 230V

Codes	Consumption		Battery Ni-Cd	Duration		Lumen
	1 Spot	4 Spot		1 Spot	4 Spot	
Non-Maintained Converter with battery						
GR-76	4VA	28VA	3.6V / 1Ah	3hrs	45min	100 / 50lm
LED Downlight						
GR-83 LED	1.5VA	-	-	-	-	40lm

Emergency

- Dimensions: 82 x 82 x 29mm
- To fit standard 3" x 3" box (75 x 75mm)



LED "Weatherproof Spotlight" - Emergency Luminaires IP65

Codes	Voltage	Consumption	Light Source	Light Output
LED - Non-Maintained				
GR-80	230VAC	6VA	9 LEDs	30lm

• Flush mounting in junction box or plaster board.

STEEL LED EMERGENCY EXIT SIGNS

Steel LED Emergency Exit Signs - Input Voltage: 230VAC | Self Contained | Surface Mount | Certificate No. 159443/001



LED-EXIT-1



LED-EXIT-2



LED-EXIT-3

Codes	LED Wattage	Emergency Time	Battery Type	Size (mm)
LED-EXIT-1	2W	2hrs	Ni-Cad	375 x 25 x 147
LED-EXIT-2	2W	2hrs	Ni-Cad	375 x 25 x 147
LED-EXIT-3	3W	3hrs	Ni-Cad	430 x 45 x 215

2-year warranty on all LED products & 1-year warranty on battery-operated products, unless specified. LED warranty void without surge protection. Refer to page 128.

©ACDC Dynamics

EMERGENCY ILLUMINATION

	Wall Mount	Double Sided c/w 25cm chains	Legends
			 - RIGHT
Code Non-Maintained	LED808NM	LED308SNM	-
Code Maintained	LED808M	LED308SM	KE328
Lamp	0.9W	0.9W	0.7W
Mounting	Recessed ceiling mount	Wall Mount	Ceiling Mount
Material	Sheet Steel & Polycarbonate	Sheet Steel & Polycarbonate	Aluminium & Acrylate Plastic
Battery	3.6V 900mAh > 3hrs	3.6V 900mAh > 3hrs	Ni-Cd 3.6V 350mAh > 3hrs
Size (mm)	410 x 140 x 240	392 x 190 x 61	370 x 52 x 500
Legends			 - LEFT
Exit	KEX808-EXIT	KE308S-EXIT	-
Down	KEX808-DOWN	-	KE328-DOWN
Left	-	KE308S-LEFT	KE328-L/R
Right	-	KE308S-RIGHT	KE328-L/R
			 - DOWN
Code Non-Maintained	-	-	IP65
Code Maintained	KES112LED	KE338	KE108/LED/M
Lamp	0.7W	0.9W	16W
Mounting	Recessed Ceiling Mount	Ceiling Mount	Wall or Ceiling Mount
Material	Aluminium & Acrylate Plastic	Aluminium & Acrylate Plastic	Polycarbonate Plastic
Battery	3.6V 900mAh > 3hrs	3.6V 900mAh > 3hrs	3.6V 4.5Ah > 3 hrs
Size (mm)	65 x 340 x 470	400 x 52 x 530	Ø320 x 115
Legends			 - EXIT
Exit	KES112LED-EXIT	KE338-EXIT	-
Down	-	KE338-DOWN	-
Left	KES112LED-L/R	KE338-L/R	-
Right	KES112LED-L/R	KE338-L/R	-

Maintained: When mains power is on the light is on. When mains fails the light stays on Non-Maintained: When mains power is on the light is off. When mains fails the light comes on.



LED Emergency Twin Spot IP65 - Automatic operation | Built-in charger |

Back-up time: > 3hrs

Code	Supply	Battery	Lamps	Size (mm)
KE448LED-NM	230VAC	3.6V 6Ah	2 x 6W	305 x 305 x 76

Ceiling Mount Exit Emergency Light IP20 - 230V Both side indicator

Codes	Power	Battery Ni-Cd	Duration	Size (mm)	Auto Switch On Power Failure
DL-758S	1 x 8W	6V/1.2AH	1.5hrs	410 x 90 x 160	Yes

*1st Tube for permanent light, 2nd Tube for emergency light. Include battery c/w internal charger



RECHARGEABLE EMERGENCY LED LIGHTS



EMG-A60
5W, 9W



EMG-A60-12W



EMG-DIM-A60



EMG-GU10-3W
EMG-GU10-5W
EMG-GU10-7W

LED A60 Emergency Lamp - Working Time: 4 - 5 Hours

Code	Wattage	Lumens	EMG Lumens	Size (mm)	Base
EMG-A60-5W-*	5W	375lm	250lm	60 x 108	E27 with B22
EMG-A60-9W-*	9W	675lm	300lm		Adaptor
EMG-A60-12W-*	12W	900lm	350lm	80 x 170	

Dimmable A60 Emergency Lamp - 3 Step dimming on DC Mode | 300lm - 2hrs, 120lm - 4hrs, 50lm - 7hrs | c/w Shorting Cap and Hook | Overcharge & Discharge Protection

Code	Wattage	Lumens	EMG Lumens	Size (mm)	Base
EMG-DIM-A60-7W-*	7W	650lm	50lm	Ø60 x 120	E27 with B22
EMG-DIM-A60-9W-*	9W	880lm	120lm	Ø65 x 133	Adaptor
EMG-DIM-A60-11W-*	11W	1100lm	300lm	Ø70 x 145	

*Add colour to code: ○ CW (Cool White), ○ DL (Daylight)

LED GU10 Emergency Lamp - Working Time: 2-3 Hours

Code	Wattage	Lumens	EMG Lumens	Size (mm)	Base
EMG-GU10-3W-*	3W	190lm	85lm	Ø50 x 55	GU10
EMG-GU10-5W-*	5W	350lm	120lm	Ø50 x 55	GU10

*Add colour to code: ○ WW (Warm White), ○ CW (Cool White), ○ DL (Daylight)

Dimmable GU10 Emergency Downlight - 3 Step dimming on DC Mode | 135lm - 2.5hrs, 60lm - 5hrs, 24lm - 7hrs | c/w Shorting Cap and Hook | Overcharge & Discharge Protection

Code	Wattage	Lumens	Size (mm)	Base
EMG-DIM-GU10-6W-*	7W	450lm	Ø50 x 80	GU10

*Add colour to code: ○ CW (Cool White), ○ DL (Daylight)



LED Floodlights with Emergency Backup Power IP65 - Input Voltage: 230VAC | 110° Beam Angle | Colour Temp. 6000K | 3 Hour Backup Time | Lithium Ion Battery

Code	Wattage	Emg. Watts	Lumens	Size (mm)
EMG-FL-20W-DL	20W	6W	100lm/W	170 x 168 x 36
EMG-FL-50W-DL	50W	10W	120lm/W	214 x 188 x 41
EMG-FL-100W-DL	100W	10W	120lm/W	253 x 231 x 52

Standard LED Emergency Lamps for Domestic Use - Supply Volts 230VAC | Complete with battery charger | Charging Time: 24 hours | Perfect for use as a portable work lamp

Code	Lumen	Battery	Discharge Time	Size (mm)
RWELEDJ-2	Low - 40lm High - 80lm	3.7V 1200mAh	Low - 6hrs High - 3hrs	270 x 65 x 52
NS350LX	300-350lm	3.7V 1200mAh	4hrs	220 x 65 x 40
NS650LX	270lm	4VDC	4hrs	395 x 60 x 44
LED008	98+220lm	3.7V 2200 mAh	8hrs single LED 4hrs multiple LEDs	220 x 77 x 120
AL-2166	360lm	3.7V 1.8Ah Li-ion	Max Power up to 1.5hrs Low Power up to 10hrs	325 x 55 x 30
AL-3600	360lm	3.7V 1.8Ah Li-ion	Low - 4hrs High - 2hrs	392 x 58 x 43
AL-2060	400/200lm	3.7V 3.0Ah Li-ion	Low - 8hrs High - 4hrs	360 x 75 x 50
JCL-T5-901-4W	400lm	3.7V 1.8Ah Li-ion	6hrs	300 x 40 x 23
JCL-T5-901-6W	600lm	3.7V 1.8Ah Li-ion	6hrs	600 x 40 x 23



RWELEDJ-2

NS350LX

NS650LX

LED008

AL-2166

AL-3600

AL-2060



JCL-T5-901



AS-8221



AS-8222

Rechargeable LED Lamps - Lamp can be operated from the mains or from the built in battery | Charge time: 4hrs | Battery life: 4hrs when fully charged | Automatic emergency illumination function | Supplied with a lampholder adaptor so that the lamp can be used in Bayonet or screw-in fittings

Code	Description
AS-8221	LED emergency lamp c/w E27 lamp holder adaptor and ON/OFF remote
AS-8222	LED emergency lamp c/w E27 lamp holder adaptor

CHICKEN FARM LIGHTING SYSTEM



AMB-IDS

Programmable Dimmer & Timer IP66 - Input Voltage: 230VAC | Support DIY Programming | Master / Slave Function, supports both Triac & 0-10V Dimming. "Master Function" - Control dimming from the unit, "Slave Function" - Use central 0-10V control system dimming. | Leading Edge & Trailing Edge | 0%-100% Dimmable, dimming precision 1% | 7 inch LCD | Easy replacement for traditional lamps, no need to rewire the existing cable installation.

Code	Output Current	Max Watts
AMB-IDS-2000W	1 x 10A	2000W
AMB-IDS-4000W	2 x 10A	4000W



WP4A

A Series - T8 Triac Dimmable IP66 - Input Voltage: 230VAC | Double V-Shape 150° Viewing Angle | CRI > 80 | L80B50 70 000hrs | **Full spectrum** | Dimming from 0.2% - 100% without flicker to simulate sunrise to sunset | 300mm male and female connector for series connection | Anti-ammonic and acid for poultry industrial lighting | To be used with **AMB-IDS** controller

Code Triac	Wattage	Lumens	Length (mm)
WP4A-T8-20W-D-*	20W	2000lm	1200 x 28

* Add Colour Temperature to Code: ○WW (3000K), ○CW (4200K), ○DL (5000K)



AMB-PE

AMB-TC

AMB-ME

A Series - T8 0-10V Dimmable IP66 - Input Voltage: 230VAC | V-Shape 150° Viewing Angle | CRI > 80 | L80B50 70 000hrs | **Full spectrum** | Dimming from 3% - 100% without flicker to simulate sunrise to sunset | 300mm male and female connector | Anti-ammonic and acid for poultry industrial lighting | Compatible with any 0-10V Control System

Code 0-10V	Wattage	Lumens	Length (mm)
WP4E-T8-20WH-D-*	20W	2000lm	1200 x 28

* Add Colour Temperature to Code: ○WW (3000K), ○CW (4200K), ○DL (5000K)

Accessories

Code Triac	Description	Code 0-10V	Description
AMB-PE	1m Power Extension	WP4E-PE	1m Power Extension
AMB-ME	4m Middle Extension	WP4E-ME	4m Middle Extension
AMB-TC	"T" Connector	WP4E-TC	"T" Connector
AMB-M15	15m Extension from Controller	WP4E-M15	15m Extension from Controller
AMB-EC	End Cap	AMB-EC	End Cap

Mounting Accessories

Code	Description
AMB-SK	Suspended Mounting Kit (Complete for 1 Tube)
AMB-CM	Ceiling Mounting Kit (Complete for 1 Tube)
AMB-RM	Ring Mounting kit (Complete for 1 Tube)



AMB-SK

AMB-CM

AMB-RM



BE27

Poultry Farm LED Lamp IP65 - Input Voltage: 230VAC | 4200K | Dimmable 0 - 100% | Beam Angle: 220° | Working Temperature: -20° to 50° | Alumite treated to protect against corrosion.

Code	Wattage	Lumens	Size (mm)
BE27-7W	7W	700lm	Ø43 x 158
BE27-12W	12W	1200lm	Ø49 x 179

UV DISINFECTION SYSTEMS



360° UV Disinfection Lamp - Input Voltage: 230VAC | Irradiation Area 50m² | UV Startup Delay 10s | Quartz Ultraviolet Lamp | Rated 10000hrs | U-Tube 340mm | All metal Lamp Holder | c/w Remote | Wavelength UV 253.7nm, Ozone 185nm

Code	Wattage	Spectrum	Size (mm)
PTX-003-WH	38W	UVC+Ozone	210 x 210 x 470

Accessories

Code	Description
PTX-003-LAMP	Spare Lamp UN-C 253.7nm

LED PLANT GROW LIGHTS

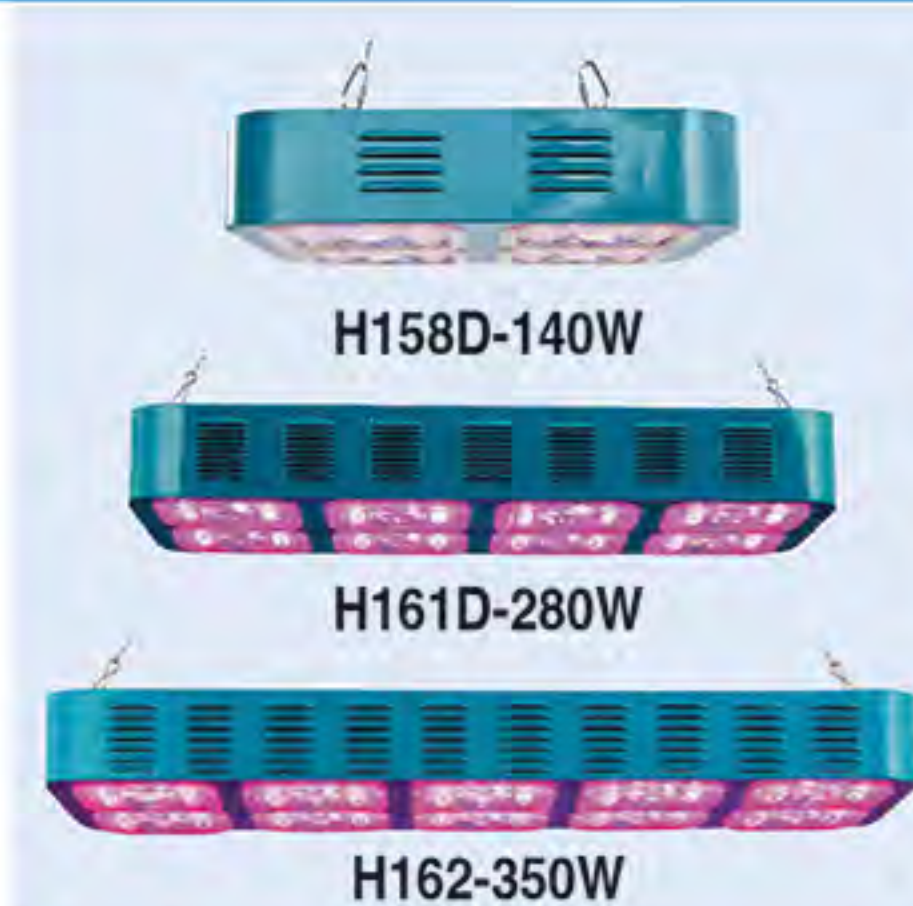

LED Plant Grow Lights - Easy maintenance: Modular system • Air circulation system design - to obtain the ideal CO_2/O_2 ratio considerably improving plant growth | Self testing function - when indicator light is on, the light module is faulty and needs to be changed.

Code	Input Voltage	Output Power	Lumens	Size (mm)
H158D-140W	100-240VAC	140W	6180lm	280 x 280 x 70H
H161D-280W	100-240VAC	280W	10563lm	540 x 280 x 70H
H162-350W	100-240VAC	350W	13204lm	670 x 280 x 70H

Accessories

Code	Description
H4-MOD-35W	Spare light module 35W
H4-DRV-70W	Spare LED Driver (one driver drives 2 light modules)

LED PLANT GROW LIGHTS



T8 Plant Growing SMD LED Tubes - Input Voltage: 85-265VAC | Plant grow lamps have LED's that produce light in Blue (450nm) and Red (660nm) wavelengths that are ideal for promoting photo-biological processes in plants. These lamps can be used wherever plants do not receive enough natural light or in agricultural applications.

Code	Length	Power	Replaces T8 Lamp
LEDT8PG-A2FR	600mm	9W	18W (2FT)
LEDT8PG-A3FR	900mm	15W	30W (3FT)
LEDT8PG-A4FR	1200mm	18W	36W (4FT)
LEDT8PG-A5FR	1500mm	22W	58W (5FT)



LED PAR38 Plant Grow Lamp - IP65

Code	Base	Watts	Lumen
LED-PAR38-12W-PG	E27	12W	171lm

- 75% Red, 25% Blue
- The wave length for red is 662nm, for blue is 447nm



A60 LED Filament Plant Grow Lamp E27 - Input Voltage: 220 - 240VAC | Dimensions: Ø60 x 108mm | Full Colour Spectrum for general use | Ideal for greenhouse glass or plastic, Planting factory, Hydroponic shelves, Home Planting.

Code	Wattage	Colour Spectrum	PPF (400-700nm)	PAR Watt (/W) (400-700nm)	PPF (400-700nm)
XGY-A60-8-E27	8W	Full Spectrum	>12 μ mol	0.3 - 0.5mW	>1.5 μ mol/s/W



LED Plant Grow Strips IP65 - Supplied with 230VAC Power Adaptor | LED Strip 24VDC Lumens: 10-22lm | Viewing Angle: 120° | Blue (Wave Length: 455-465nm) - Good for Photosynthesis | Red (Wave Length: 660-665nm) - Peak Wavelength for Photosynthesis & Photoperiodism - Good for Blooming & Fruits | Red/Blue in one Chip: Red:Blue = 5:1 (Suitable for most Plant Growing)

Code	Description	No. LEDs	Max Power/m	Length
HH-SRB60W	Red/Blue 5:1	60lm	14W/m	10m
HH-SRB120W	Red/Blue 5:1	120lm	28W/m	10m
HH-SR-60W	Red	60lm	14W/m	10m
HH-SB-60W	Blue	60lm	14W/m	10m



LED Plant Grow Floodlight IP65 - Input Voltage: 230VAC | Beam Angle 120° | Red¹⁶ & Blue⁴ | Wavelength: Red 630-660nm, Blue 400-470nm

Code	Wattage	Lumens	Size (mm)
PG-GY225TG-20W	20W	1300lm	200 x 180 x 45



Clamp Grow Lights IP44 - Input Voltage: 85-265VAC | Lamp Life 50 000hrs | 360° Adjustable Head | Easy Mounting System

Code	No. of Heads	Wattage	Red : Blue : White	Goose Neck Size (mm)
CGL-15	1	1 x 12W	5 : 4 : 3	Ø95 x 495
CGL-30	2	2 x 12W	5 : 4 : 3	Ø95 x 495

PPFD per Head: 579 μ mol @ 200mm / 434 μ mol @ 300mm
Coverage per Head: 400 x 400 @ 300mm / 500 x 500 @ 400mm

TORCHES

	HardCase Pivot	Impact Light	Basic Plastic Led	Water proof light	Tactical
Code	EL-HC-PIVOT	EL-IMPACT-2AA	EL-PLASTIC-2D	EL-WPROOF-2AA	EL-TAC700-RC
Lumens	300lm(high)/30lm Low	60lm	25lm	55lm	700lm
Batteries	2xAA included	2xAA included	2xD not included	2xAA included	Rechargeable
Working Time	5h(high)/30h(Low)	30h	120h	35h	Up to 2h
Effective distance	Up to 30M	65m	35m	50m	Up to 100m
IP rating	IPX4	-	-	IPX7	IPX4
Features	<ul style="list-style-type: none"> Pivoting Head Magnetic foot Drop tested: 7m 	<ul style="list-style-type: none"> Durable Rubber construction Built in stand for hands free use Non-slip grip 	<ul style="list-style-type: none"> Easy to operate Long runtime Lanyard included 	<ul style="list-style-type: none"> Floats With reflective panels Durable construction 	<ul style="list-style-type: none"> Durable aircraft grade aluminium Strike bezel head Multiple lighting modes
Code	SP-F08	SP-FL32	SP-FL3WC	SP-402-7C	SP-018
Wattage	8W	1W	3W	0,5W	0.5W
Lumens	800lm	100lm	150lm	1200 - 1400 MCD	60lm
Batteries	3 x C (not incl)	3 x AAA (not Incl)	3 x AAA (Not Incl.)	3 x AAA (Not Incl)	-
Rechargeable	No	No	No	No	Yes (Shake to Recharge)
Size (mm)	Ø43 x 255	Ø25 x 91	Ø45 x 123	87 x 77 x 66	Ø27 x 170
	<p>Comes in case with charger & car adaptor Spare Battery: SP-T1000-BAT</p>				
Code	SP-T1000	SP-BLH015	5JG-9915	5JG-A370	
Wattage	1W	3W	3W (CREE)	3W (CREE)	
Lumens	100lm	120lm	330lm	330lm	
Batteries	3.7V Li-ion (Incl)	450mAh	3 x AAA (Incl)	2 x 18650 Lithium Battery (Incl)	
Rechargeable	Yes	USB	Yes	Yes	
Size (mm)	Ø32 x 155	Ø26 x 92	Ø55 x 195	Ø70 x 190	
	<p>5-in-1 Mini LED Pocket Lamp</p> <p>1 x USB 5VDC Charging Cable Colour Temp: 6000K c/w Magnet and Swivel Hook</p>	<p>Pen Light</p> <p>Magnetic Base & Hook</p>	<p>Aluminium Torch</p>	<p>360° Rotatable Head</p> <p>Magnetic base Detachable head</p>	<p>360° Rotatable Head</p> <p>Magnetic base Detachable head c/w Motion Sensor</p>
Code	SPWL-44AR	SP-WL32C	SP-SNL14D	HL-TC6145-1	HL-TC6145-2
Wattage	20SMD + 3PCS	3W	3W	3W	5W
Lumens	400lm	200lm	120lm	100lm	300lm
Batteries	3.7V 1200mAh Lithium Battery	3 x AAA (Not Incl.)	4 x AAA (Not Incl.)	3 x AAA (Not Incl.)	3 x AAA (Not Incl.)
Rechargeable	Yes	No	No	No	No
Size (mm)	97 x 68 x 25	40 x 18 x 160	20 x 75 x 14	Ø76 x 75	Ø76 x 75

Portable

LIGHTING

HEAD LAMPS

	Rechargeable c/w Adaptor & Batteries				
Code	SJ-2469	SP22-B058B	SP-WL606	SP2022	EL-V-HL-200LM
Lumens	1300 MCD	12000-14000MCD	120lm	300lm	200lm(high)/45lm(low)
Batteries	3 x AAA (Not Incl)	3 x AAA (Not Incl)	3.7V 1200mAh	800mAh	3 x AAA (Not Incl)
Work Time	-	-	-	3hrs Charge / 2hrs Discharge	7h(High)/20h(Low)
Effective Distance	-	-	-	-	Up to 50m
IP Rating	-	-	-	-	IPX4
Features	• 2,4,8 LED On • LED flashing • OFF	• Mode 1: 1 LED ON • Mode 2: 7 LED ON • Mode 3: Flashing	• On/Off Wave Sensing	• Steady on • Flashing • On/Off Wave Sensor	• Pivoting head • 2 modes

WATERPROOF BICYCLE HEAD LIGHTS

			
Code	DY-H001	DY-H010	DY-H013
Wattage	3W	6W	9W
Lumens	250lm	500lm	700lm
Light Modes	High / Low / Flash	Low / Medium / High / Flash	Low / Medium / High / Flash
Batteries	4.2V 2000mAh	8.4V 440mAh	8.4V 440mAh
Rechargeable	Yes	Yes	Yes

Kit Includes: Charger, Battery Pack, Battery Case, Headband, Mounting Ring

BICYCLE LIGHTS

	c/w Charging Kit			With rear light		
Code	SJ-2657	JF404-1W	SJ-2750	SJ-2659	HL-BK4090	
Wattage	1.5W	1W	1.5W	0.3W	0.4W	
Lumens	8400MCD	40000MCD	60000MCD	Head light: 2lm, Tail light: 3lm	4lm	
Batteries	4xAA (not incl.)	3 x AA (36V 600mA) Incl	3 x AAA (not incl.)	Head 4 x AAA (not incl.) Rear 2 x AAA (not incl.)	3.7 280mAh Lithium Battery	
Rechargeable	No	Yes	No	No	Yes	
Size (mm)	52 x 80 x 112	85 x 72 x 100	32 x 54 x 80	95 x 30 x 50	43 x 27 x 40	

CAMPING LIGHTS

						
Code	YDC-5W-DL	CJ-2703	SJ-3040*	RW-DL-2	CS2008GR	EL-V-LANTERN-RC
Wattage	5W	2W	1W	3W	3W	-
Lumens	500lm	120lm	90lm	130lm	300lm	1000lm High
Batteries	3,7V 4400mAh Li-ion	2 x AA (Not Incl.)	3 x AAA (Not Incl.)	3000-4000-5000K (Adjustable)	400mAh	-
Rechargeable	Yes 4-5hrs working time	No	No	Yes Run time on full charge 8-10hr	Yes Run time on full charge 8-10hr	Yes
Size (mm)	Ø80 x 117	Ø135	Ø135	120 x 220	Ø105 x 160	305 x 200 x 75



*Add colour to code: ● S(Silver), ○ WH (White)

2-year warranty on all LED products & 1-year warranty on battery-operated products, unless specified.
LED warranty void without surge protection. Refer to page 128.

WORK LIGHTS

<p>IP67 with magnet</p>	 <p>LED</p>	<p>Magnet & 360° Flexible Hook</p>  <p>LED</p>	<p>NEW</p> <p>360° Rotation Hook Magnetic Base</p>  <p>LED</p>
------------------------------------	---	--	---

Code	SP-W814	SP-WL47B	SP-WL14ARC
Lamp	1 LED Top + 3W COB Inside	3W	1W + 3W COB
Lumen	300lm	300lm	70lm - 120lm
Power Supply	3.7V 1800mAh Rechargeable 18650 Li-ion Battery	3 x AA (Incl)	3.7V 1800mAh Li-ion USB
Battery Life	3hrs	-	-

 <p>165mmØ</p>	 <p>125mmØ</p>	
---	---	---

Code	HL-13	AWL-009	JLM8933
Power	1 million/0.5 million Candle Power		2 million Candle Power
Lamp	12V 55W		12V 100W
Spare Lamp	H3-55-12VDC		H3-100W-12VDC
Description	6" Spotlight c/w car lighter plug		6" Spotlight c/w car lighter plug

<p>NEW LED</p> 	<p>230VAC</p> 	<p>230VAC</p> 	<p>12VDC</p> 	<p>230VAC</p> 
--	---	---	--	---

Code	SP-001	AWL-006	LK608007	AWL-006-DC	SP-JK1115
Power	20W LED (2000lm)	60W max (E27)	60W max (E27)	60W max (E27)	100W max (E27)
Lamp	-	-	-	-	-
Spare Lamp	-	-	-	-	-
Description	Material: PC + ABS, 5m Lead, Top Hook & Handle Hook	Auto Lamp c/w 3m cable	Metal frame with rubber protection c/w 3m cable	Connects into car lighter	Auto Lamp c/w 3m Cable

Portable LIGHTING

WORK LIGHTS

	3-in-1 Torch / Lantern / Powerbank		2-in-1 Torch / Lantern		LED Working Floodlight	
	c/w Charging Adaptor 1 x USB 5VDC/500mA 2 x 4VDC for Lamps LED Side View Back View 	c/w Charging Adaptor 1 x USB 5VDC/500mA c/w USB Charger LED 	c/w Built in Charger LED Side view 	3 Working Mods: 100% - 60% - 20% - EMG Full Charge - 10hrs Work Time NEW 		
Code	YJ-2886	SPHL8916	YJ-2829	TG01-30W	TG01-50W	
Wattage	1 x 5W + 22 SMD	Front 5W Side 1.5W	1 x 5W + 25 SMD	30W	50W	
Lumens	550lm	450lm	550lm	6000lm	10000lm	
Batteries	2 x 2200mAh	2 x 3600mAh	6000mAh	3.7V / 5Ah	3.7V / 10Ah	
Rechargeable	Yes	Yes	Yes	USB / Car Charger / Adaptor		
Size (mm)	Ø100 x 140 x 190	95 x 170 x 135	Ø120 x 220	218 x 280 x 57	245 x 324 x 60	
	Floodlight / Spotlight Mode Emergency Flash IP44 LED 	Rotatable 90° Swivel Tripod Stand LED 	Detachable Side Light-Flashing Amber Retractable Tripod Stand LED 	Swivel Stand Two Brightness Settings LED 		
Code	KB8201	KB8933CP	KB2601A	KB2146-20W		
Wattage	10W	10W	10W + 3W	20W		
Lumens	700lm	650lm	850lm	1600lm		
Batteries	3.7V 2400mAh	Direct	7.4V 2400mAh	7.4V 2400mAh		
Rechargeable	ACDC or 12VDC Car Adaptor / USB	No 12VDC Car Plug	ACDC Adaptor / 12VDC Car Charger / USB	ACDC Adaptor / 12VDC Car Charger / USB		
Size (mm)	220 x 147 x 166	280 x 290 x 320	208 x 122 x 240	226 x 165 x 179		
PORTABLE	NEW 6000K 180° Adjustable LED Head LED 	NEW 6000K LED 	NEW 6000K LED 			
	Code	SP-016	SP-019	SP-010A		
Wattage	2 x 10W	2 x 10W	2 x 10W			
Lumens	2 x 700lm	2 x 1000lm	2 x 1000lm			
Batteries	4000mAh	3.7V 2 x 2000mAh	3.7V 2 x 2200mAh			
Rechargeable	USB	Yes	Yes			
	Charge Time 4 hrs 3-6hours Run Time	Charge Time: 5hrs Working Time: 2hrs 100%	Charge Time: 4-5hrs Working Time: 2-4hrs			
Size (mm)	205 x 245 x 50	Ø41 x 416	Ø65 x 650			
Features	Magnetic Base Battery Indicator Dimmable 100-50%	Back to Back Work Light Can join two single sides Modes: 100% on / 50% on c/w Hook & Magnetic Vase	Double sided Work Light 360° c/w Tripod Hook Magnetic Bottom Modes: one side - two sides - off			

2-year warranty on all LED products & 1-year warranty on battery-operated products, unless specified.
LED warranty void without surge protection. Refer to page 128.

DECORATIVE LED LAMPS

Shade Material:
White glass
Base Material:
Painted
Aluminium
c/w Remote
Control



Code	TAM-RGB/WW	YAM-RGB/WW	GLAM-RGB/WW	LUCIA-RGB/WW	LUNA-RGB/WW
Wattage	5.5W	5.5W	5.5W	6.5W	5.5W
Lamp Colour	RGB & Warm White	RGB & Warm White	RGB & Warm White	RGB & Warm White	RGB & Warm White
Size (mm)	Ø137 x 258	Ø137 x 258	Ø200 x 198	Ø200 x 200	Ø250 x 200
Spare Remote	RGB/WW-REMOTE	RGB/WW-REMOTE	RGB/WW-REMOTE	RGB/WW-REMOTE	RGB/WW-REMOTE

Material: Plastic



Code	OVORG-02	IM880-*	IM887	IM891	LV-2015
Wattage	0.7W	0.55W	3W	0.5W	5W Speaker / 3.5W Light
Lamp Colour	RGB	White	RGB	Warm White	White
Feature	Colour Changing & Dimming	Glowing Mushroom Cap	Built in MP3 Player	Dimmable	Bluetooth
Size (mm)	Ø110 x 180	75 x 75 x 190	Ø109 x 241	80 x 80 x 120	Ø120 x 130

* Add mushroom cap colour to code: ● BL (Blue), ● GN (Green), ● O (Orange), ● Y (Yellow), ● P (Purple)

LED VENUE DECORATION LIGHTING

Rechargeable Light Modules - Working Time: 8 - 12 hrs. Charge Time: ±4hrs



Code	SL-L117	SL-L117D	SL-L120DS	SL-L120D
Power Output	2W	2W	1W	2W
Size (mm)	Ø117	Ø117	Ø120	Ø120
Charging Type	Induction Charging	Direct Charging	Induction Charging	Induction Charging
Kit Includes	LED light, remote control, battery, adaptor, waterproofing ring			

LED DECORATIONS



Charger



Colour Changing

LED Colour Changing Light Ball (Indoor) - Rechargeable Batteries & 230VAC Battery Charger included | Colours include: Red, Green, Yellow, Blue, White, Cyan, Purple and Twinkle | Colour selectable or colour changeable by pressing switch | Batteries Included

Code	Volts	Core	Material	Size (mm)
LB-001	4.5V	Empty	Silica Gel	Ø81



Garden LED Egg Shaped Decorative Light Kit IP68 - 3 x Eggs with 1m cable from egg to egg | Colour: ● R, ● GN, ● BL | Single Colour or Colour Changing | Complete with Power Supply and 7m cable

Code	Volts	Core	Material	Size (mm)
SL333115	2.7W	Light 24VDC with controller 230VAC	Polyresin	165 x 95 x 85

BELT LIGHTS



Input Voltage: 240VAC | **IP54** | Illumination Cable c/w Lamp Holders at Set Spacing | Indoor & Outdoor Applications | c/w 2700K 2W LED filament lamps

Code E27	Length	Lamp Spacing	No of Lamps	Control Wires
DC-S14-10M-E27	10m	1m	10	2
DC-S14-10M-E27/0.5	10m	0.5m	20	2
DC-S14-15M-E27	15m	1m	15	2
DC-S14-15M-E27/0.5	15m	0.5m	30	2

Accessories

Code	Description
DC-E27-2W-CW	Plastic 2W Lamp / Cool White 4200K
DC-E27-2W-WW	Plastic 2W Lamp / Warm White 2700K



Input Voltage: 100-240VAC | Illumination Cable c/w Lamp Holders at Set Spacing | Indoor & Outdoor Applications | 2 Wire for Static

IP65 Code B22	IP54 Code B22	Length	Lamp Spacing	No of Lamps	Control Wires
BL-10-B22	-	10m	450mm	20	2
BL-15-B22	BL-ACDC-15-B22	15m	375mm	40	2
-	BL-ACDC-50-B22	50m	700mm	70	2
BL-100-B22	BL-ACDC-100-B22	100m	700mm	143	2



Input Voltage: 230VAC | **IP65** | Fixed RGBW Lamp | Lamp Type: G45 | c/w Controller | 8 Modes | Ideal for Indoor and Outdoor Applications

Code E27	Length	Lamp Spacing	No of Lamps	Control Wires
BLS-10M-RGBW	10.4m	800mm	12 (1W)	5



Coloured LED Belt Light IP44 - Input Voltage: 230VAC | Low Voltage Outdoor Party & Festive Lights | c/w Transformer | Power Cable Length: 5m | Connectable | Filament LED | Plastic Bulb with Mounting Hooks

Code	Length	Lamp Spacing	No. of Lamps
LED Golf Ball Multi-Colour			
BL-LV-5M-M	5m	500mm	10
LED A60 Multi-Colour			
BL-LV-A60-5M-M	5m	500mm	10
LED G45 RGB (Auto Colour Changing)			
BL-LV-G45-5M-RGB	5m	500mm	10



BELT LIGHTS



Solar Powered LED Belt Light IP65 - c/w 6W, 6V Panel | 240 x 150mm | 1W LED Lamps | Charge Time: 8-10Hrs | Working Time: 13-15Hrs | LiPo 5200mAh Battery | Ideal for Indoor and Outdoor Applications | Colour Temp: 3000K

Code E27	Length	Lamp Spacing	No of Lamps	Control Wires
SOL-BL-7.3M-WW	7,3m	730mm	10	2
SOL-BL-10.4M-WW	10,4m	800mm	10	2

SMART BELT LIGHTS IP56



WiFi RGBIC String W+ Fairy Lights: Power Supply-DC5V | Digital RGB Function

Code	Type	Watts	No.Lamps (String light + Fairy Light)	Length	Lamp Spacing
HH-HM-SSFL15	String lights + Fairy lights	10W	15 + 50	15m	1m/0.3m

Note: Includes IR Remote controller, power adaptor, IP44 Smart controller and 15m belt light

ACDC SMART SWITCH

- App Control
- WiFi Control
- Remote Switching
- Set Timers & Schedules
- Count Down Timer
- Colour RGB Adjustable
- Dimmable
- Music
- Share Control with Others

● R (Red), ● GN (Green), ● BL (Blue), ○ W (White)

works with the Google Assistant

WORKS WITH amazon alexa

2-year warranty on all LED products & 1-year warranty on battery-operated products, unless specified. LED warranty void without surge protection. Refer to page 128.

LED ROPE LIGHTS IP44

10 000 Hours life	⊙ 2-Wire Round	⊙ 3-Wire Round	⊙ 3-Wire Rectangular
	13mm	13mm	11 x 18
● Red	RL-LED2-*R	RL-LED3-*R	RE-L3-*R
● Green	RL-LED2-*G	RL-LED3-*G	RE-L3-*G
● Blue	RL-LED2-*B	RL-LED3-*B	RE-L3-*B
● Yellow	RL-LED2-*Y	RL-LED3-*Y	RE-L3-*Y
○ White	-	-	RE-L3-*W
○ Warm White 2700K	RL-LED2-*WW	RL-LED3-*WW	-
○ Day Light 6000K	RL-LED2-*DL	RL-LED3-*DL	-
Mixed (R, G, Y, B)	RL-LED2-*M	RL-LED3-*M	RE-L3-*M

*Add Length to code: 10m or 50m



Controller To be ordered separately

Accessories supplied All 10 meter Flexi Lights are supplied with: Power Cord, End Cap and 6 piece Mounting Clips
All 50 meter Flexi Lights are supplied with: Power Cord, 3 Middle Joint Connectors, 3 End Caps and 30 piece Mounting Clips

Accessories for:	2-Wire Round	3-Wire Round	11 x 18 3-Wire
Controller for 10m	WK-220	WI-310B	-
8 Function Controller	DK-05-2	DK-06-4	DK-06-4-RE
Power Cord c/w Connector 50m	F-1-LED	RL-1-LED	SF3-1
End Caps	F-4	F-4	SF2-3
Coupling (Splice Connector)	F-5	RL-5	SF3-4
Mounting Clip, Plastic	F-6	F-6	SF2-5

Mounting rails for 5 x 8 LED rope light		
	Code	Description
	CH-1PVC	PVC mounting rail
	CH-2PVC	Step edge to carpet mounting rail
	CH-3PVC	Mounting rail for carpet both sides



Rope Length for MLF Series only			
Colour	Watts	Max. length with the following converters	
		1.6A	4A
White	2.6W	160m	400m
Red	1.56W	264m	660m
Blue	2.6W	160m	400m
Green	2.6W	160m	400m
Yellow	1.5W	264m	660m

Accessories 13mmØ

Description	⊙ Code 2 Wire	⊙ Code 3 Wire
Mains cord c/w connector	F-1	RL-1
Powercord connector	F-3	RL-3
End cap	F-4	F-4
Flexilight Coupling (splice connector)	F-5	RL-5
Mounting clip	F-6	F-6
Easy Splice connector with shrink tube	F-7	RL-7
Y Cord to join 3 lengths	F-9	RL-9
Suction Cups	F-10	F-10
T Connector	F-11	RL-11
PVC Channel – clear, 1 meter length	F-12	F-12
Waterproof Coupling (splicing kit) to be filled with Silicon Glue	F-14	RL-14
	F-28	F-28



Controllers 240VAC

Description	Speed Adj.	Function	Max Loading	Max Amps	Code 2 Wire	Code 3 Wire
Indoor IP44	Yes	Flashing	17m	1.2A	WL-220	-
Indoor IP44	Yes	Chasing	17m	1.2A	-	WL-310
Indoor IP44	Yes	Flashing	30m	2.2A	WL-210C	-
Indoor IP44	Yes	Chasing	30m	2.2A	-	WL-310C
Indoor IP44	No	8 Function w/mem	12m	1.2A	WL-310B-DI2C	WL-310B
Indoor IP44	Yes	Static, Flashing	100m	8A	WL-2C	-
Indoor IP44	Yes	Static, Flashing	100m	8A	WL-2C-2P*	-
Indoor IP44	Yes	6 Function chasing	100m	8A	WL-3C-DI2C	WL-3C
Indoor IP44	Yes	6 Function chasing	100m	8A	-	WL-3C-2P*
Outdoor IP55	Yes	8 Function	17m	1.2A	-	WL-310K
Outdoor IP55	No	8 Function	30m	2.2A	-	-
Outdoor IP55	No	16 Function	25m	1.8A	-	WL-318



* With 2 Output Connectors for controlling 2 Flexilight, max 100m total length.

2-year warranty on all LED products & 1-year warranty on battery-operated products, unless specified. LED warranty void without surge protection. Refer to page 128.

ROPE & FIREWORK FLEXILIGHTS



10mm Ø Flexilight (with fuse lamps) **IP65**

Colour	Symbol	2 Wire (Steady/Flashing) 10m
Green	●	RL2-10-10G
Red	●	RL2-10-10R
Yellow	●	RL2-10-10Y
Mini controller for 10m IP44		DN-2W-2C

Accessories

Code	Description
F10-4	Spare End Cap for 2-wire 10mm diameter Flexilight
F1-4	Mains Cable c/w Connector

Flexilights are supplied complete with mains cords, end cap and connector.

Controller to be ordered separately see page 162.



Rectangular Flexilight 11mm(H) x 18mm(W) with fuse lamps **IP65**

Colour	11mm 2 Wire Steady/Flashing	11mm 3 Wire Chasing
Clear	-	SF3M-10C
Red	SF2M-*R	SF3M-50R
Green	SF2M-10G	SF3M-*G
Aqua Blue	SF2M-50AB	SF3M-*AB
Yellow	SF2M-*Y	SF3M-*Y
Neon Green	-	SF3M-10NG
Neon Orange	-	SF3M-10NO
Mixed (R, G, B, Y)	SF2M-10M	SF3M-*M

Accessories

Description	Code 2 Wire	Code 3 Wire
Mains Cord and Connector	SF2-1	SF3-1
End Cap	SF2-3	SF2-3
Coupling (splice connector)	SF2-4	SF3-4
Mounting Clips (plastic)	SF2-5	SF2-5
*Controller for 10m Indoor	WL-220-R	WL-310-R
*Controller for 100m Indoor	WL-2C-R	WL-3C-R

*Add length to code: 10m or 50m Flexilights are supplied complete with mains cords, end cap and connector.

NEW

LED ROPE LIGHT WITH CONTROLLER



LED 13mm Ø Special Flexilight **IP65** - 230V. (Controller (**IP44**) to be mounted in weatherproof box)

Colour	Symbol	3 Wire (3 Colour Chasing) 10m c/w controller
Red, White, Yellow & Blue	● ○ ● ●	LED-RL-3W-10M
Clear / LED DL		LED-RL-3W-10C-DL (6000K) Daylight
Clear / LED WW		LED-RL-3W-10C-WW (3200K) Warm White

Above Flexilights are supplied complete with mains cords, end cap, connector and 8 function controller.

Colour	Symbol	2 Wire 3-Colour 10m c/w multi-function controller
Red, Green, & Blue	● ● ●	LED-RL-2W-10M

Above Flexilights are supplied complete with mains cords, end cap, connector and 8 function controller.

LASER PROJECTORS **IP44**



TOP-A1



Projected Images

Laser Shower - Input Voltage: 230VAC | c/w Remote, Ground Spike & Tri-Pod | Fairy Light Projection and various images

Code	Projection	Beam Distance	Coverage	Size
TOP-A1	Red/Green Laser	30m	3000ft ²	240 x 183 x 127

Landscape Projector - Input Voltage: 230VAC | c/w Remote, Ground Spike & Tri-Pod | Project Images using slides (Additional Slides to be ordered separately) | Supplied with Slides 3 & 4

Code	LED	Beam Distance	Coverage	Size
TOP-B1	4 x 3W LED	10m	600ft ²	Ø95 x 135 x 140

TOP-B1 Accessories

Code	Description	Code	Description
TOP-B1-SLIDE1	C3 & C4 Slide for TOP-B1	TOP-B1-SLIDE3	C1 & C2 Slide for TOP-B1
TOP-B1-SLIDE2	C5 & C6 Slide for TOP-B1	TOP-B1-SLIDE4	C7 & C8 Slide for TOP-B1



TOP-B1-SLIDE1

TOP-B1-SLIDE2

TOP-B1-SLIDE3
(Slides included with Light)

TOP-B1-SLIDE4
(Slides included with Light)

Festive

LIGHTING



TOP-B1

NEW

LED STRING LIGHT IP44

Voltage: 230VAC | Supplied with 1.5m Power Cord | Linkable | Moulded LED Lamps | No Controller required for multi-colour | Suitable for outdoor use

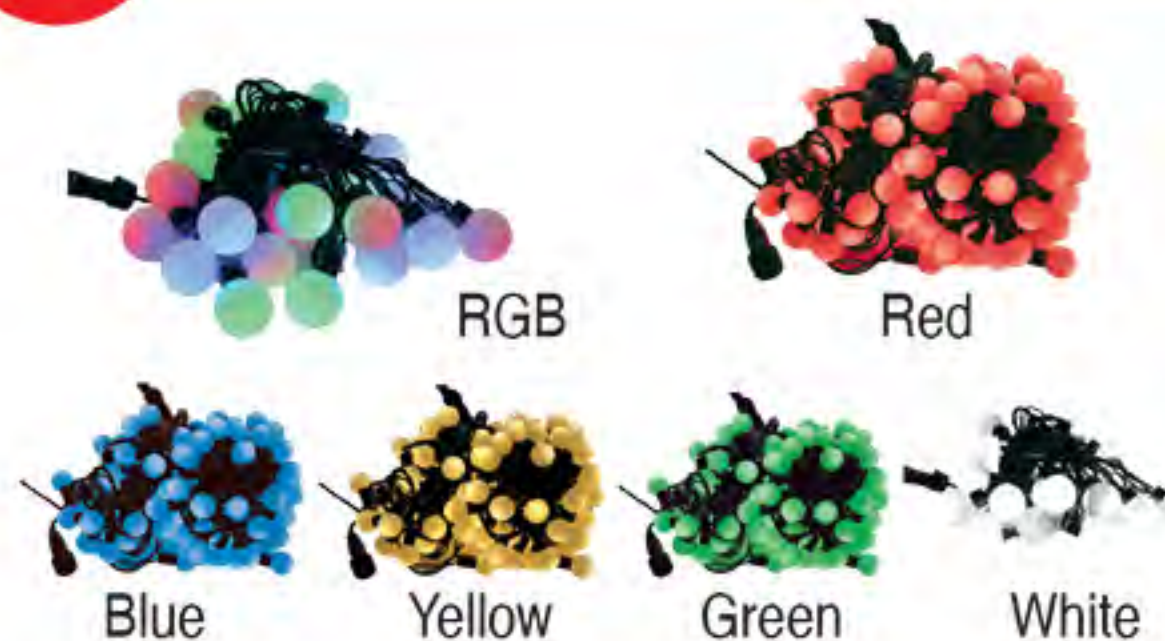

Code	Wattage	LED Bulbs	Length	Colour
ST-102T-5M-50-M	4.4W	50	5m	RGB (●●●)
ST-102T-10M-100-M	8.8W	100	10m	RGB (●●●)
ST-102T-5M-50-*	4.4W	50	5m	●●●●○

*Add colour to code: ● R (Red), ● Y (Yellow), ● BL (Blue), ● GN (Green), ○ W (White) 6000K

NEW

SMART FAIRY LIGHTS IP56

WiFi Fairy String Lights: Power Supply-DC5V | Digital RGB Function



Globe String Lights Fairy String Lights

Code	Watts	No. Lamps	Type	Colour
HH-HM-GFLT5	5W	33	Globe	●●● Digital RGB
HH-HM-FSLT5B	5W	50	Fairy String	●●● Digital RGB

Note: Kit includes Remote, Smart Controller, String Fairy Lights and Power Adaptor

● R (Red), ● GN (Green), ● BL (Blue), ○ W (White)

works with the Google Assistant

WORKS WITH amazon alexa

LED FESTIVE LIGHTS IP44

LED Flexi-Star - Indoor/Outdoor Tree Lights (100 000 hours) 240V



Code	Colour of Bulb	No. of Channel	Length	No. of Bulbs	Controller Included IP44	Watts Total
LS2-80WW-8-W	WW (2700K)	2	8m	80	8 Function	3.2W
LS2-100C-12-G	White (5500K)	1	12m	100	8 Function	9.6W
LS2-160C-5-*	White (5500K)	2	5m	160	8 Function	6.4W
LS4-160C-5-*	White (5500K)	4	5m	160	8 Function	6.4W
LS2-160R-5-*	Red	2	5m	160	8 Function	6.4W
LS2-160B-5-*	Blue	2	5m	160	8 Function	6.4W
LS2-160M-5-*	Multi	2	5m	160	8 Function	6.4W
LS2-320C-10-*	White (5500K)	2	10m	320	8 Function	12.8W
LS4-320C-10-*	White (5500K)	4	10m	320	8 Function	12.8W
LS2-320M-10-G	Multi	2	10m	320	8 Function	12.8W

*Add colour of wire to code: ● G (Green), ○ W (White), ○ T (Transparent)

LED Net Lights - (100 000 hours) 240V Indoor use only IP44 (extendable)

Code Black Wire	Code Clear Wire	Code White Wire	Colour of Bulbs	Size	Lamp		8 Function Controller
					No.	W (total)	
LFN-252-C-G	LFN-252-C-C	LFN-252-C-W	White (5500K)	1.5 x 2m	252	16,8W	Included
LFN-324-C-G	LFN-324-C-C	LFN-324-C-W	White (5500K)	1.5 x 3m	324	16,8W	Included
LFN-252-M-G	LFN-252-M-C	LFN-252-M-W	Multi	1.5 x 2m	252	19W	Included
LFN-324-M-G	LFN-324-M-C	-	Multi	1.5 x 3m	324	28W	Included
LFN-252-WW-G	LFN-252-WW-C	LFN-252-WW-W	Warm White	1.5 x 2m	252	19W	Included
-	-	LFN-324-WW-W	Warm White	1.5 x 3m	324	28W	Included

2-year warranty on all LED products & 1-year warranty on battery-operated products, unless specified. LED warranty void without surge protection. Refer to page 128.

LED FESTIVE LIGHTS IP44

Curtain Light - (100 000 Hours) Indoor use only. **IP44** (extendable)



Code White Bulb (5500K)	Code Warm White Bulb	Code Twinkle Daylight (5500K) NEW	Curtain Width x Drop	No of Strings	Lamps per String	Watts
LFC3C-20-2/1*	LFC3WW-20-2/1W	-	2 x 1.0m	20	36	16.8W
LFC3C-20-2/1.5*	LFC3WW-20-2/1.5*	LFC3C-T-20-2/1.5T	2 x 1.5m	20	36	16.8W
LFC3C-20-2/3*	LFC3WW-20-2/3*	LFC3C-T-20-2/3T	2 x 3m	20	36	33.6W
LFC3C-20-2/5*	LFC3WW-20-2/5*	LFC3C-T-20-2/5T	2 x 5m	20	72	67.2W
LFC3C-20-2/10*	LFC3WW-20-2/10*	-	2 x 10m	20	108	100.8W

* Add -W to code for White Wire. Standard items supplied with Black Wire. Controller to be ordered separately. Note IP rating of controller. **WL-310B-LFC3C** (1.2A) 288W **IP44**. **WL-310K-LFC3C** (1.2A) 288W **IP55**

Icicle Light - (100 000 Hours) 240V Indoor use only. **IP44** extendable

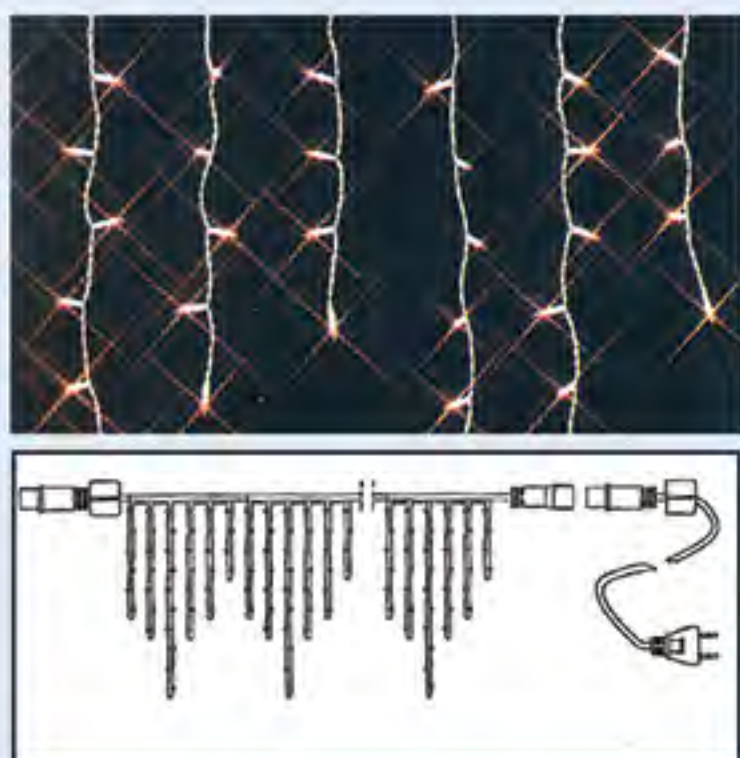

Code	Code Twinkle NEW	No. of Channel	Length		No. of Bulbs	Power Watts	Controller Included
			W	H			
LFI1-60*-1.7*	-	1	1.7m	0.5m	60	4.8W	Excluded
LFI1-90*-2.5*	-	1	2.5m	0.5m	90	4.8W	Excluded
LFI1-240*-5*	LFI1-T-240*-5T	1	5m	1m	240	9.6W	Excluded
LFI1-250-WW-W	-	1	3.5m	1m	250	9.6W	Excluded
LFI4-240*-5*	-	4	5m	1m	240	9.6W	8 Function

*Add colour to code: ○ C (Cool White 5500K), ○ WW (Warm White)

*Add colour of wire to code: ● GN (Green), ○ W (White), ○ T (Transparent)

Twinkle: *Add colour to code: ○ WW (Warm White), ○ C (Daylight 5500K), ○ WWC (Warm White Static, 5500 Flashing)

LED Round Sparkle Net Lights - (100 000 hours) 240V Indoor use only

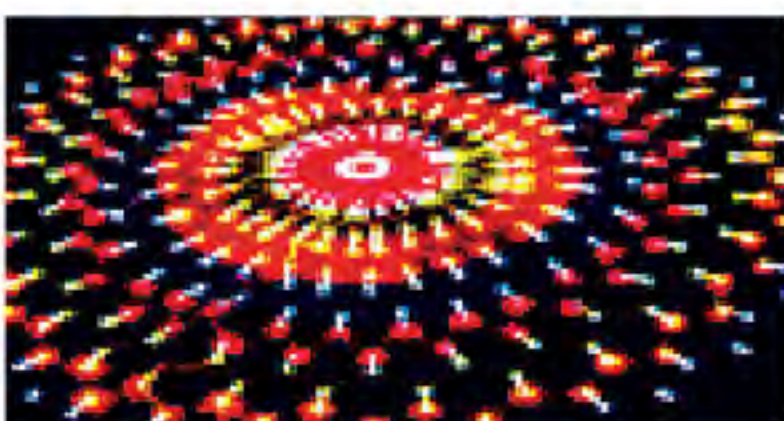

Code Green Wire	Colour of Bulbs	Type	Size	LED Quantity	Controller Included
CM-RNL-C	White	Chasing	1m Ø	80	2 Function
CM-RNL-M	Multi	Chasing	1m Ø	80	8 Function

LED Extendable Flexi-Star - (100 000 hours) Indoor/Outdoor use. PVC wire. **IP44**



Code Static	Code Twinkle Transparent Wire NEW	Colour of Bulb	No. of Bulb				Power Consumption				Max. Extendable Set			
			5m	10m	12m	50m	5m	10m	12m	50m	5m	10m	12m	50m
LRS2-100C-*	-	White (5500K)	-	-	100	500	-	-	7.6W	38.14W	-	-	20	4(sets)
LRS2-100M-*	-	Multi	-	-	100	500	-	-	7.6W	38.14W	-	-	20	4(sets)
LRS2-160C-12*	LRS2-T-160C-12-T	White (5500K)	160	-	160	800	9.6W	-	9.6W	48W	20	-	20	4(sets)
LRS2-160C-50-G	-	White (5500K)	160	-	160	800	9.6W	-	9.6W	48W	20	-	20	4(sets)
LRS2-160M-*	-	Multi	-	-	160	800	-	-	9.6W	48W	-	-	20	4(sets)

LED Flexi-Star - (100 000 hours) Indoor/Outdoor use. PVC wire. **IP44**

LRS2-160C-5-G	-	White (5500K)	160	-	-	-	9.6W	-	-	-	Not Extendable
LRS2-320C-10*	-	White (5500K)	-	320	-	-	-	19.2W	-	-	Not Extendable
LRS2-320M-10-G	-	Multi	-	320	-	-	-	19.2W	-	-	Not Extendable

*Add length to code: 5 (5m), 12 (12m) or 50 (50m) | *Add colour of wire to code: ● G (Green), ○ W (White)

*Add colour of wire to code: ● G (Green), ○ W (White), ○ T (Transparent)

BATTERY OPERATED LED FESTIVE LIGHTS

Battery Operated Starlight - Indoor use only | 2 Wire LED light string with white battery box | Wire colour: Silver | Length: 2 meter | 20 LEDs in a 2 meter Length | Approximate battery life: 72 HRS (Dependant on type of battery)

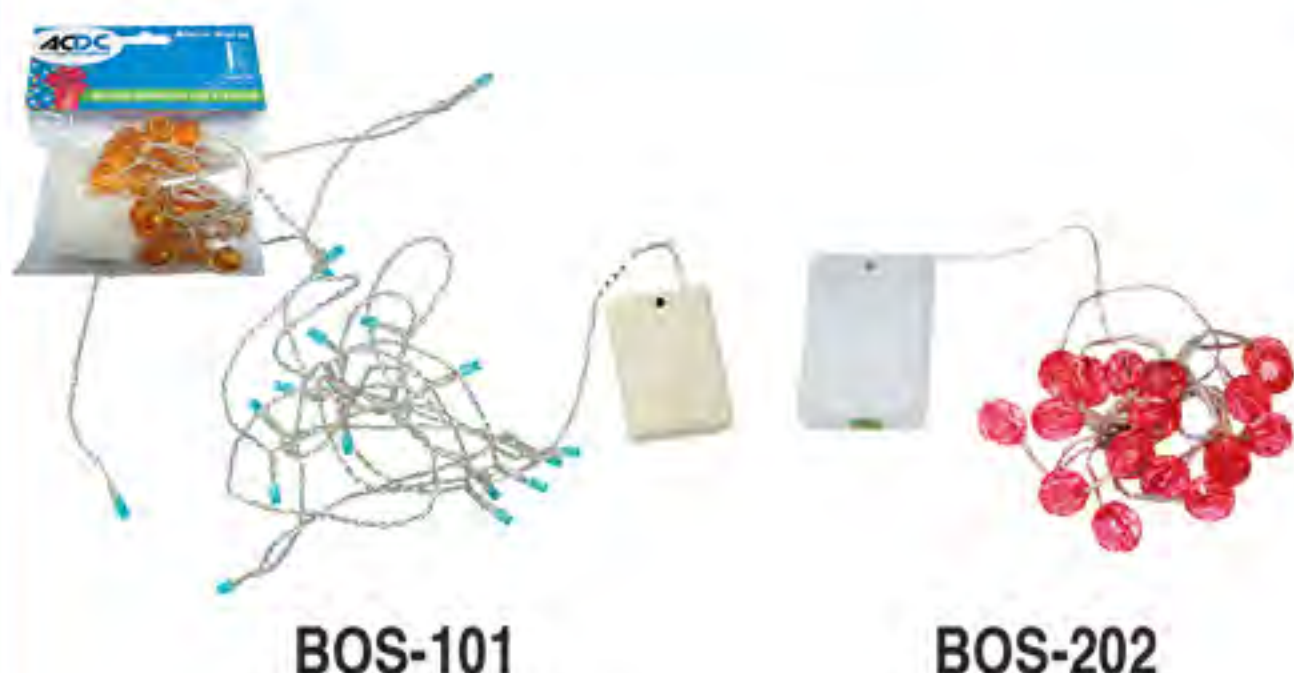

BOS-101

BOS-202

Code	Description	*Add Colour to Code
BOS-101*	Battery operated LED flexistar	○ WW (Warm White), ○ CW (Cool White), ● R (Red), ● BL (Blue), ● GN (Green), ● Y (Yellow), ● G (Gold)
BOS-202*	Battery operated LED flexistar with clear crystal balls	○ WW (Warm White), ○ CW (Cool White), ● R (Red), ● BL (Blue), ● GN (Green), ● Y (Yellow), ● OR (Orange)

2-year warranty on all LED products & 1-year warranty on battery-operated products, unless specified. LED warranty void without surge protection. Refer to page 128.

SOLAR FESTIVE LIGHTS IP44

3 Levels on timer: 6h, 8h and 10h adjustable | Working time after full charge: 20-40hrs (time for full charge: 8hrs in direct sunlight) | Charging period for one night (±8-16hrs): 4hrs in direct sunlight | On/Off: automatically turn on at 75±25lx, turn off at 350±50lx in one minute by photo sensor

Solar panel with integrated controller							
	Solar LED String Light	Solar Icicle Light	Solar Curtain Light	Solar Net Light			
Code	TEA-7D02-B05-*	TEA-7D02-B10-*	TEA-7D06-B10-*	TEA-7D06-B20-*	TEA-7D08-B10-*	TEA-7D08-B20-*	TEA-7D10-B20-*
Length (m)	5	10	1.6 x 0.6	2.0 x 1.0	1.6 x 0.6	2.0 x 1.4	1.6 x 0.6
No of LEDs	50Pcs	100Pcs	96Pcs	200Pcs	96Pcs	200Pcs	96Pcs

*Add colour to code: ○ CW (Cool White), ●●●M (RGB)

LED FESTIVE LIGHTS IP44

	LED Clip Light					LED Knitting Lights
	Code	LEDs	Watt	Colour	Description	 Code CM-STR-M 80 Red, 20 Green, 20 Yellow & 20 Blue LED's Complete with 8 function Controller Voltage: 240V Size: 910 x 910mm.
	LCLT-*G-RGB	160/10m	7W/10m	RGB	LED RGB Clip light colour changing; c/w 8 function controller; 4 wire	
	LCLT-*G-RGB-AUTO	160/10m	7W/10m	RGB	LED RGB clip light auto colour changing; with controller to control fading; 2 wire	
	LCLT-*G-WW	160/10m	7W/10m	White	LED warm white clip light c/w transformer; no controller; 2 wire	
LCLT-*G-PW	100/10m	7W/10m	White	LED pure white clip light c/w transformer; no controller; 2 wire		
*Add length to code: 10 (10m), 50 (50m), 100 (100m)						

LED TUBE EFFECT LIGHTING



LED Falling Star Effect Tubes - Input Voltage: 220VAC

Code	Effect	1 Kit	Size (mm)	LED's/Tube
RW-LK30-18-*	Chasing	8Pcs	Ø12 x 300(L)	18 LED's
RW-LK50-30-*			Ø12 x 500(L)	30 LED's
RW-LK60-33-*		5Pcs	Ø12 x 600(L)	33 LED's
RW-LK60-33-RGB			Ø12 x 600(L)	33 LED's

Kit includes connecting cables and mains adaptor | *Add colour to code: ● R (Red), ● GN (Green), ● Y (Yellow), ● BL (Blue), ○ WH (White)

LED BALL MOTIF

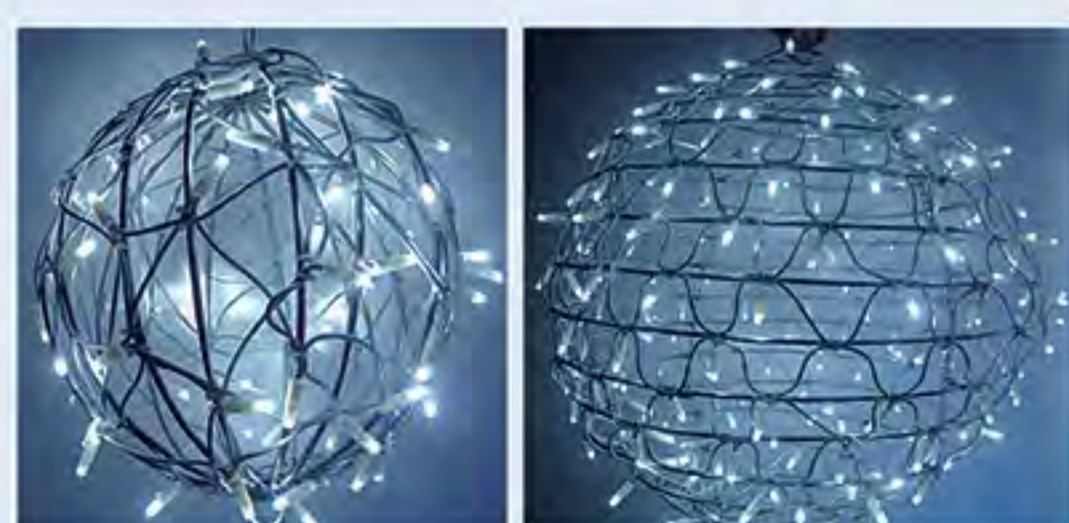

LED-LBL-220L-*

LED-LBL-80L-*

Smart LED Christmas Tree

Code	Description
LED-LBL-220L-*	Ø600mm Ball motif with 150 LEDs, black wire, Indoor
LED-LBL-80L-*	Ø300mm Ball with 55 LEDs, black wire, Indoor

*Add LED colour to code: ○ W (White), ● R (Red), ● GN (Green), ● Y (Yellow), ● BL (Blue)

SMART XMAS TREE



Smart string lights

Input Voltage: 100-240VAC
100+ Light Shows App Controlled | RGB, 16 million colours | 2.4G Wifi | c/w Controller

Code	FI-710
No. of Strings	7
No. of LEDs / String	10
String Length	140cm
Max Wattage	15W

FESTIVE LIGHTING

Flexi-Star Indoor/Outdoor TREE LIGHTS (28 000 hours) 240V



Code	Colour of Bulb	No. of Channel	Length	No. of Bulbs	Controller Included IP44	Watts
FS2-160C-5*	Clear	2	5m	160	8 Function	96W
FS4-160C-5*	Clear	4	5m	160	16 Function	96W
FS2-160R-5*	Red	2	5m	160	8 Function	96W
FS2-160B-5*	Blue	2	5m	160	8 Function	96W
FS2-160M-5*	Multi	2	5m	160	8 Function	96W
FS2-320C-10*	Clear	2	10m	320	8 Function	68W
FS4-320C-10*	Clear	4	10m	320	16 Function	68W
FS2-320M-10*	Multi	2	10m	320	8 Function	68W

*Add colour of wire to code: ● GN (Green), ○ W (White), ○ T (Transparent)

Controller WL-310B with memory. For outdoor use, controller to be mounted in weatherproof box

(25 000 Hours) 240V Indoor use only. Green Wire



Code Clear Bulbs	Length	No	W (total)	Controller Included IP44	Code Multicolour Bulbs
MTL-96B-6M-C	6m	96	37W	8 Function	MTL-96B-6M-M
MTL-144B-9M-C	9m	144	66W	8 Function	MTL-144B-9M-M
MTL-180B-10M-C	10m	180	104W	8 Function	MTL-180B-10M-M
MTL-C	Spare Controller . For outdoor use, controller to be mounted in weatherproof box				

Net Light IP44

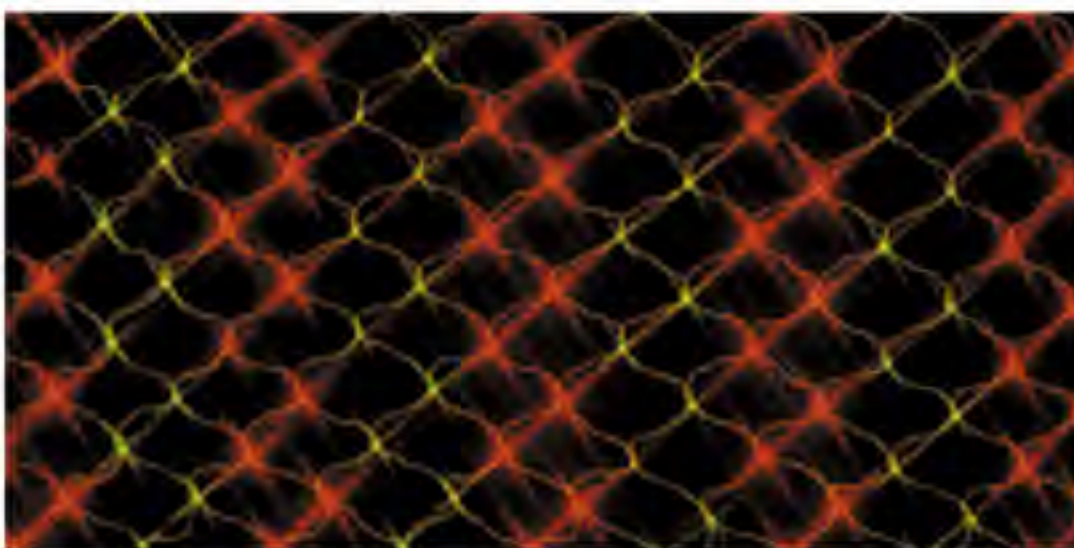

Code Green Wire	Colour of Bulbs	Size	No of Bulbs	Watts	Controller Included IP44	Code Clear Wire
NL-288-C-G	Clear	1.5 x 2m	288	96W	8 Function	NL-288-C-T
†NL-432-C-G	Clear	1.5 x 3m	432	115W	8 Function	NL-432-C-T
NL-288-M-G	Multi	1.5 x 2m	288	96W	8 Function	NL-288-M-T
NL-432-M-G	Multi	1.5 x 3m	432	115W	8 Function	NL-432-M-T

†For outdoor add 'OD' to code. eg ODNL-432-C-B (Black wire)

Icicle Light (30 000 Hours) 240V Indoor use only. IP44 extendable

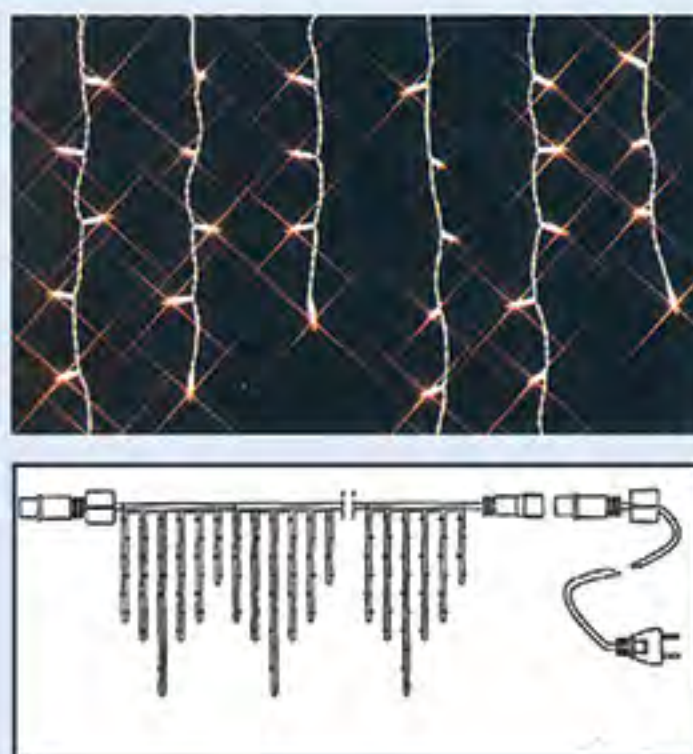

Code Green Wire	No. of Channel	Length W H	No. of Bulbs	Power Watts	Controller
FI1-60C-1.7*	1	1.7m 0.5m	60	24	Excluded
FI1-90C-2.5*	1	2.5m 0.5m	90	45	Excluded
FI1-240C-5*	1	5m 1m	240	62	Excluded
FI4-240C-5*	4	5m 1m	240	120	8 Function (IP44)

*Add colour of wire to code: ● GN (Green), ○ W (White), ○ T (Transparent)

Curtain Light (30 000 Hours) Indoor use only. IP44 black wire



Code Clear Bulbs	Curtain Width x Drop	No of Strings	Lamps per String	W (total)	Extendable Sets Max	Controller Excluded
FC3C-20-2/1	2 x 1.0m	20	36	332W	10	WL-310C-FC3C
FC3C-20-2/1.5	2 x 1.5m	20	36	332W	10	(2.2A) 506W IP44
FC3C-20-2/3	2 x 3m	20	36	332W	10	WL-310G-FC3C
FC3C-20-2/5	2 x 5m	20	36	332W	10	(2.2A) 506W IP55
FC3C-20-2/10	2 x 10m	20	36	332W	10	WL-3C-FC3C
CLS-2X6M	2 x 6m	24	74B	570W	-	(8A) 1840W IP44
CLS-2X9M	2 x 9m	24	111B	691W	-	

NEW

3D LED MOTIFS



Code	SM-I-001-220V	SM-I-002-220V	SM-I-003-220V	SM-I-065-220V	SM-I-066-220V
Size	1200 x 1000mm	2100 x 1300mm	1200 x 800mm	Ø300mm	Ø600mm
Wattage	77W	115W	77W	4W	8W



Code	SM-I-007-220V	SM-I-008-220V	SM-I-009-220V	SM-I-077A-220V
Size	1000 x 650mm	600 x 830mm	400 x 360mm	3500 x 1100mm
Wattage	35W	35W	8W	115W

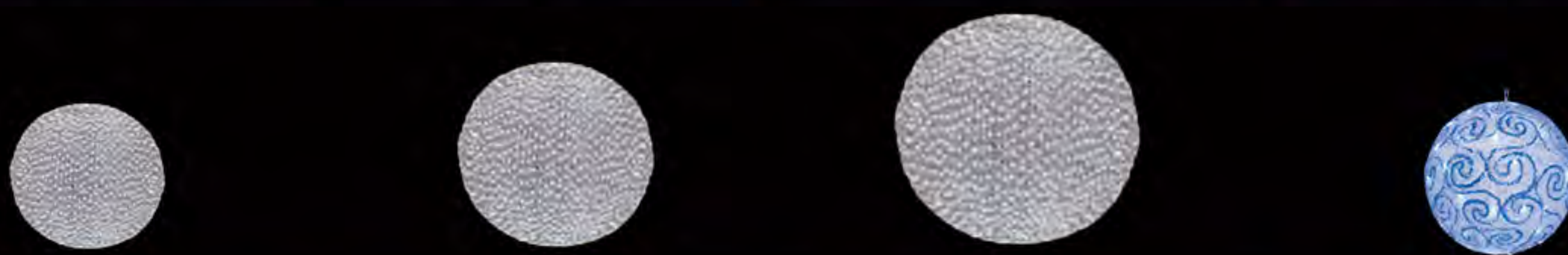

Code	SM-I-072A-220V	SM-I-072B-220V	SM-I-072C-220V	SM-I-057-220V
Size	Ø400mm	Ø600mm	Ø800mm	Ø400mm
Wattage	16W	23W	27W	8W



Code	SM-I-045A-220V	SM-I-045B-220V	SM-I-045C-220V	PHS-084-220V
Size	420 x 400 x 260mm	320 x 400 x 260mm	200 x 200 x 160mm	600 x 550 mm
Wattage	6W	3W	2.5W	60W

NEW

LASER ETCHED ACRYLIC MOTIF



Code	SM-C-002-220V-*	SM-C-001-220V-*	SM-C-003-220V-*
Size	330 x 310mm	330 x 310mm	450 x 430mm
Wattage	5W	5W	5W

*Add colour to code: ○ **CW** (Cool White), ● **R** (Red), ● **BL** (Blue), ● **GN** (Green)

2-year warranty on all LED products & 1-year warranty on battery-operated products, unless specified. LED warranty void without surge protection. Refer to page 128.

3D LIGHT MOTIF WITH STANDARD (28 000hr) LAMPS



Code	BLM-1103	BLM-1105	BLM-1106	BLM-1107	BLM-1111
Size	640 x 450mm	440 x 720mm	920 x 870mm	1120 x 690mm	400 x 1300mm
Wattage	98.28	10.2	212.94	180.18	37.4



Code	BLM-1113	BLM-1114	BLM-1115	BLM-1118
Size	780 x 2400mm	530 x 1300mm	530 x 1100mm	650 x 1400mm
Wattage	54.4W	196.8W	23.8W	213.2W

MINI ROPE LIGHT MOTIF WITH STANDARD (28 000hr) LAMPS



Code	DNM-003	DNM-007	DNM-009	DNM-012	DNM-013
Size	250 x 330mm	230 x 290mm	260 x 340mm	170 x 410mm	350 x 340mm
Wattage	1.7W	1.7W	1.7W	1.7W	1.7W

Festive

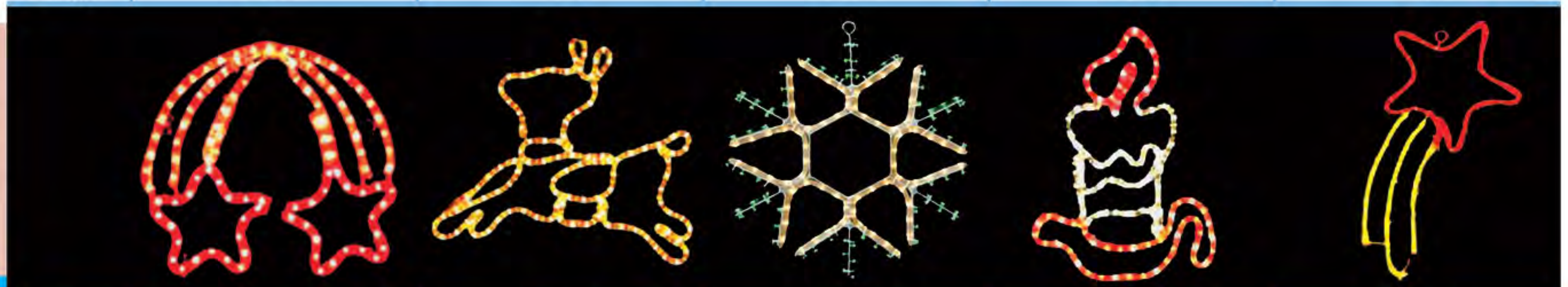

Code	NL-202	NL-105	NL-301	NL-201	NL-104
Size	360 x 420mm	400 x 500mm	Ø410mm	500 x 380mm	560 x 440mm
Wattage	8.5W	6.8W	6.8W	5.1W	6.8W

LIGHTING

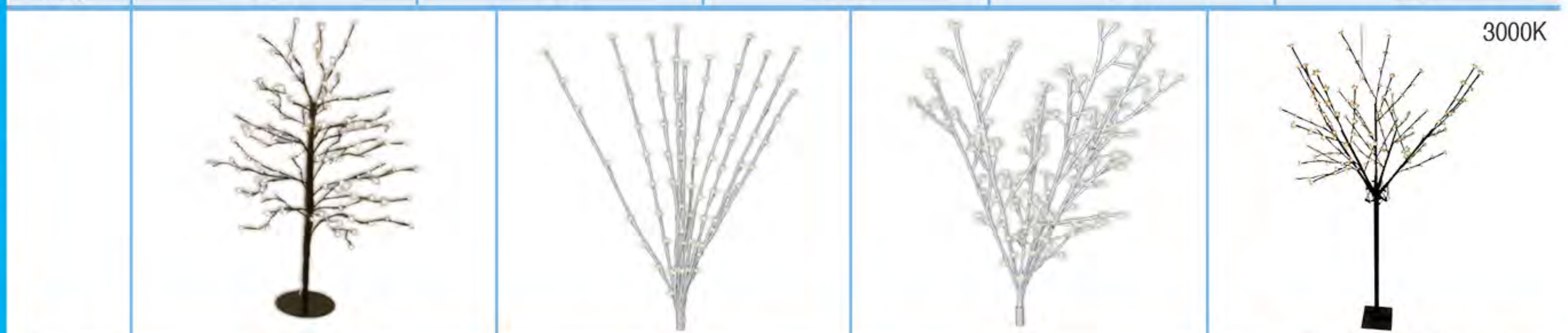

Code	BLM-1201*	BLM-1205	BLM-1206	LTL-CHERRY-1.8M-WW
Size	1200mm	800mm	1200mm	1800mm
Wattage	58W	8W	8W	6W
Colour	White/Black	White	White	Cherry

*add -BK to code for Black

2-year warranty on all LED products & 1-year warranty on battery-operated products, unless specified.
LED warranty void without surge protection. Refer to page 128.

MINI ROPE LIGHT MOTIF WITH STANDARD (28 000hr) LAMPS



Code	NL-205	NL-303	NL-204	NL-113	NL-112
Size	570 x 380mm	600 x 340mm	640 x 480mm	640 x 480mm	640 x 550mm
Wattage	5.1W	6.8W	8.5W	6.8W	8.5W



Code	NL-527	NL-116	NL-535	NL-504	NL-525
Size	650 x 850mm	680 x 480mm	750 x 580mm	750 x 750mm	730 x 930mm
Wattage	147.6W	8.5W	11.9W	15.3W	13.6W



Code	NL-503	NL-524	NL-306	NL-305	NL-307
Size	800 x 800mm	800 x 800mm	810 x 810mm	930 x 780mm	930 x 730mm
Wattage	11.9W	13.6W	10.2W	10.2W	212.94W



Code	NL-519	NL-312	NL-542	NL-543	NL-514
Size	1080 x 820mm	1100 x 750mm	1200 x 783mm	1200 x 870mm	1200 x 1200mm
Wattage	6.2W	327.6W	13.6W	18.7W	377.2W

• Indoor/Outdoor use • 2 Wire Connection • Supplied without controller, for controllers see page 162

MINI ROPE LIGHT MOTIF WITH STANDARD (28 000hr) LAMPS



Code	NL-528	NL-401	NL-604	NL-626	NL-630
Size	1230 x 1110mm	1330 x 1110mm	1500 x 700mm	1530 x 1000mm	1900 x 1300mm
Wattage	278.46W	393.6W	147.42W	18.7W	458.64W



Code	NL-605	NL-606	NL-614	NL-624
Size	2000 x 1000mm	2000 x 1100mm	2000 x 1100mm	2500 x 900mm
Wattage	13.6W	15.3W	15.3W	295.2W



Code	NL-622	NL-609	NL-545	NL-314	NL-636
Size	2500 x 1100mm	3400 x 1200mm	600 x 1400mm	730 x 1850mm	2000 x 1500mm
Wattage	278.8W	687.96W	164W	229.32W	606.8W



Code	NL-417	NL-638	NL-639	NL-660	NL-643
Size	1000 x 2000mm	1100 x 1500mm	1200 x 1500mm	1000 x 3500mm	1300 x 3500mm
Wattage	311.6W	30.6W	344.4W	492W	752W



Code	NL-648	NL-654	NL-655	NL-661
Size	1500 x 3320mm	1000 x 4000mm	1200 x 6200mm	1000 x 4000mm
Wattage	606.80W	557.6W	967.60W	820W

• Indoor/Outdoor use • 2 Wire Connection • Supplied without controller, for controllers see page 162

Festive

LIGHTING

LED DISPLAYS



c/w DIM-CG-100
universal dimmer

Code	LED-DISPLAY1	LED-DISPLAY2	LED-DISPLAY3	LED-DISPLAY3-DIM
Size (mm)	370(W) x 284(H) x 120(D)	370(W) x 284(H) x 120(D)	400(W) x 400(H) x 125(D)	
Lamp Holders	5 x 230V Sockets	4 x 230V Sockets + 1 x 12VAC Socket	5 x 230V (E27) Sockets	
Description	This Display is for 230V AC/DC Dynamics CFL and LED Lamps only.	This Display is for 230V/12V AC/DC Dynamics CFL and LED Lamps only.	This Display is for 230V AC/DC Dynamics CFL and LED Lamps only.	

LED SHOWER HEADS

No battery required 100% water driven			
	SHL003	SHL004	SHL005
Mode	Temperature Controlled	Temperature Controlled	Temperature Controlled
Features	Blue: Under 30°C, Pink: 31 - 40°C Red: 41 - 50°C, Red Flashing: Above 50°C	Blue: Under 30°C, Pink: 31 - 40°C Red: 41 - 50°C, Red Flashing: Above 50°C	Blue: Under 30°C, Pink: 31 - 40°C Red: 41 - 50°C, Red Flashing: Above 50°C
Size (mm)	Ø200 x 10	200 x 200 x 10	300 x 300 x 10
No battery required 100% water driven			
	LED SH-MC	LED SH-RGB	
Mode	Multi Colour	RGB Colour (Temperature Indicating)	
Features	When water flows the LED will light up and colour will change gradually	When water flows the LED will light up, Green when temperature is ≤ 25°C, Blue when temperature is between 26°C - 35°C, Red when temperature is between 36°C - 45°C. Red will flash when temperature exceeds 46°C	



STAGE LIGHTS

	LED 4-eyes Whirlwind Light	3-Output Laser Effect LED	LED Flowing Light	LED Moving Head Effect Light	LED Vertigo	4 x 55W Soft Light
Code	LDE-027	LDE-031	LDE-015	LDE-019	LDE-033	AVL37
Size (mm)	500 x 300 x 140	350 x 250 x 170	375 x 345 x 210	220 x 170 x 290	410 x 280 x 280	635 x 290 x 110
LED's	180 x Ø5 RGB (40W)	192 x Ø5 RGB (20W)	96 x Ø5mm (15W)	84 x 0.14 (12W)	224 x Ø5 (50W)	-
Description	11 DMX Channels, Master/Slave	Sound activated, Auto, 6 DMX channels	DMX512 signal, 4 channels including Auto, Strobe, Master/Slave, Synchronously running	DMX512 signal, 4 channels including Auto, Strobe, Master/Slave, Synchronously running	Sound activated, Auto, Master/ Slave	Fluorescent

	Firefly Laser	Green Intelligent Laser with ILDA Interface	LED Super Mini Strobe Light	LED PAR 46 - 5 Channel DMX Controller	LED PAR 56 - 5 Channel DMX Controller
Code	SML-011	AV-G100	LDE-022-*	LDP-005-*	LDP-006-*
Size (mm)	285 x 100 x 135mm	400 x 300 x 150mm	130 x 85 x 55mm	190 x 190 x 330	210 x 210 x 310
LED's	Green 532 nm: 100mW	Green 532nm: 100mW	24 x Ø5mm (5W)	94 x 0.16 (15W)	107 x 0.19 (20W)
Description	DMX512, Sound activated, Auto	DMX512, Sound activated, Auto	With speed adjustability *Add colour to code: ● R (Red), ● GN (Green), ● BL (Blue), ● Y (Yellow), ○ CW (Cool White)	Long Can Control Mode: DMX, Stand Alone, Master & Slave, Sound Activated and Auto For single colour, 2 channel DMX Strobe/ Dimmer	Control Mode: DMX, Stand Alone, Master & Slave, Sound Activated and Auto

*Add colour to code: ● R (Red), ● BL (Blue), ● Y (Yellow), ● GN (Green), ○ CW (Cool White), ○ WW (Warm White)

	LED PAR 64 - 4 Channel DMX Controller	High Power LED PAR 64	High Power LED PAR 64	PAR 64 Empty Can
Code	LDP-007-*	LDP-008-*	LDP-011-*	LDP-012-*
Size (mm)	230 x 230 x 320	230 x 230 x 400	230 x 230 x 360	230 x 230 x 360
LED's	177 x 0.17 (30W)	177 x 0.17 (30W)	36 x 1W(36W)	36 x 3W(108W)
Description	Short Can with Dip Switch DMX512 Signal, 4 Channels, including Auto, Strobe, Master-Slave and synchronously running	Long Can with Dip Switch DMX512 Signal, 4 Channels, including Auto, Strobe, Master-Slave and synchronously running	6 DMX Channels. Aluminium PAR Can. Auto, Strobe, Master Slave, Synchronously Running	6 DMX Channels Digital Display Waterproof
	*Add colour to code: ● R (Red), ● BL (Blue), ● Y (Yellow), ● GN (Green), ○ CW (Cool White), ○ WW (Warm White)		*Add colour to code: ● R (Red), ● BL (Blue), ● Y (Yellow), ● GN (Green), ○ CW (Cool white), ○ WW (Warm White), ●●● RGB	

Lamp for PAR 64 Can	
Code	PAR64-*
Size (mm)	Ø 8"
LED's	1000W (Halogen)
Description	Colour Gels to Ordered Separately

Colour Gels for PAR 64	
Code	PARGEL-*
Size (mm)	Sheet size: 100x80cm
Description	Red, Green, Blue and Yellow Available

*Add colour to code:
● R (Red), ● BL (Blue), ● Y (Yellow), ● GN (Green)

PAR LED LAMPS

- WW - 2700K
- CW - 4000K



PAR - Supply Voltage 220-240VAC | IP65

Code	Wattage	Lumens	Base	Beam Angle	*Add Colour to Code
PAR20-LED-9W-*	9W	720lm	E27	60°	WW / CW
PAR30 Non-Dimmable					
PAR30-LED-13W-*	13W	1000lm	E27	60°	WW / CW
PAR38 Non-Dimmable					
PAR38-LED-17W-*	17W	1360lm	E27	60°	WW / CW
PAR38-LED-22W-*	22W	1800lm	E27	60°	WW / CW



PAR LED Colour - Supply Voltage 220-240VAC | IP65

PAR20-4407-*	6W	450lm	E27	42°	●R / ●G / ●B / ●Y
PAR30 Colour					
PAR30-4206-*	10W	800lm	E27	42°	●R / ●G / ●B / ●Y
PAR38 Colour					
PAR38-4306-*	15W	1300lm	E27	30°	●R / ●G / ●B / ●Y

- WW - 2700K
- CW - 4000K



PAR Lamps - Supply Voltage 85-260VAC | IP65 | Same shape as original PAR

LEDPAR20-*	5W	425lm	E27	60°	WW / CW / ●R / ●GN / ●BL / ●Y
LEDPAR30-*	9W	765lm	E27	60°	●BL / ●Y
LEDPAR38-12W-*	12W	1170lm	E27	60°	●●●M (Colour Changing)

LED RETROFIT LAMPS

	LED 4 Pin Lamp	LED Circline Lamp	
LED 2D Type		- 4 Pin G10q Base - Internal Driver 	
Code	2D-LEDR-14W-*	TOP-C225-16W	TOP-C299-20W
Watts	14W	16W	20W
Voltage	100-240V	90-264V	90-264V
Lumen	1150lm	1280lm	1660lm
Size (mm)	Ø224 x 24H	Ø225 x 30H	Ø299 x 30H
Base Type	GR10q	G10q	G10q
Colour Temp.	-	6000K	6000K
*Add colour to code	WW / CW	-	-

LED AR111 LAMPS

	Non - Dimmable			Coloured	Dimmable	
Code	L058-AR111-12W-*	LEDAR111-12W-*	MDS-AR111-12W-*	LEDAR111-9W-*	KL-AR111-12W-*	KL-AR111-15W-*
Wattage	12W	12W	12W	9W	12W	15W
Base	GU10	G53	GU10	GU10	G53	GU10
Supply Voltage	230VAC	12-24VAC/DC	230VAC	230VAC	12VAC/DC	230VAC
Lumens	850 - 1100lm	1000lm	1000lm	800lm	850-1100lm	1275lm
Beam Angle	45°	45°	120°	45°	60°	40°
*Add colour to code	WW / CW	WW / CW	WW / CW	●R / ●GN / ●BL / ●Y	WW / CW	WW / CW

CARBON FILAMENT

Carbon Filament Lamps - 110-240V | Dimmable



Code	Power	Base	Filament Shape	Size (mm) Ø x H
Globe Type				
A21-25W-*	25W	E27/B22	Quadloop	68 x 125
A21-40W-*	40W			
A21-60W-*	60W			
Candle Flame Type				
FC35-25W-E14	25W	E14	Z-Style	35 x 120
FC35-40W-E14	40W			
Pear Shape Type				
ST58-40W-*	40W	E27/B22	Squirrel Cage	58 x 135
ST58-60W-*	60W			
Large Ball Type				
G125-40W-*	40W	E27/B22	Squirrel Cage	125 x 175
G125-60W-*	60W			

*Add base to code: **E27** or **B22**

STANDARD FILAMENT LAMPS

Halogen Classic A60 - 230VAC | Ø60 x 107



Code E27	Code B22	Code E14	Watts	Lumen
A60-28-E27	A60-28-B22	-	28W	672lm
A60-72-E27	A60-72-B22	-	72W	1728lm

Incandescent A60 - 230VAC or 110VAC

Code	Watts	Lumen
E27-25-*	25W	350lm

*Add voltage to code: **230V** or **115V**

Incandescent Golf Ball Lamps - 230VAC | Ø45 x 77

Code	Watts	Lumen
E27-15-Y	15W	210lm

*Add colour to code: ● **R** (Red), ● **GN** (Green), ● **Y** (Yellow)



Halogen Flame Lamps - 230VAC

Code	Watts	Lumen
FLM-E27-28W	28W	672lm
FLM-E27-42W	42W	1008lm

Incandescent Flicker Flame Lamps - 230VAC

Code	Watts	Lumen
FFL-E14-3W	3W	42lm

INCANDESCENT LAMPS

● **E14** ● **BA15D**

*Add Voltage



Incandescent Lamps

Type	E14	Watts	BA15D	Watts	BA15D	Watts	E14	Watts	BA15D	Watts
Size	16 x 45		16 x 45		35 x 56		45 x 75		16 x 54	
Volts: *12	ACL1*	5	ACL31*	5	-	45	-	-	-	7
24	ACL1	5	ACL31*	5	ACL42*	45	-	-	ACL61*	7
110/130	ACL1	7/10	ACL31*	10	-	-	ACL51*	40	ACL61*	7
230/240	ACL1/2	7/10	ACL31*	10	-	-	ACL51*	40	ACL61*	7



PAR56 - For swimming pools | 12V

Code	Watts	Base
ACL81	120W	Fast on

PAR46 - For swimming pools | 12V

Code	Watts	Base
ACLP46	100W	Fast on

PAR38 - 230/240V

Code	Watts	Base
ACL91	75W	E27

Frosted Reflective - 230/240V



Code	R	Watts	Base
ACL72	50	40W	E27
ACL74	80	75W	E27
ACL75	80	100W	E27

FLUORESCENT LAMP PROTECTION SLEEVES



Fluorescent Colour/ Lamp Protection - The coloured "Tubos" are a practical and economical solution for transforming a normal fluorescent lamp into a coloured one. AC/DC Tubos will give you protection, economy, UV-ray filters and coloured lamps. Suited for the Food & Beverage industry

Code	Exterior Ø	Interior Ø	Wattage	Length	*Add Colour to Code:
AKO-TUBO18-*	28.7mm	26mm	18W	590mm	T (Transparent), ●BL, ●G, ●R, ●A
AKO-TUBO36-*	28.7mm	26mm	36W	1200mm	T (Transparent), ●BL, ●G, ●R, ●A, ●O
AKO-TUBO58-*	28.7mm	26mm	58W	1500mm	T (Transparent), ●BL, ●G, ●R, ●Y, ●A, ●O
AKO-TUBO28-T	18.7mm	16mm	28W	1149mm	T (Transparent)
AKO-TUBO35-T	18.7mm	16mm	35W	1449mm	T (Transparent)

HIGH POWER CFL LAMPS



Watts	Lumen	D Type Code	Length	F Type Code	Length
30W	1530lm	-	-	F17-LH30-E27	168mm
40/45W	2040lm	-	-	F17-LH45-E27	220mm
50/55W	3000lm	-	-	F17-LH55-E40	260mm
65W	3315lm	ESL42-65-*-D	258mm	F17-LH65-E40	285mm
80W	4335lm	ESL42-80-E40-D	293mm	-	-
85W	4335lm	-	-	F17-LH85-E40	280mm
120W	4620lm	-	-	F17-LH120-E40	305mm
150W	5500lm	-	-	F17-LH150-E40	305mm
200W	9600lm	ESL42-200-E40-D	360mm	-	-
250W	14850lm	ESL42-250-E40-D	400mm	-	-

*Add to code: E27, E40

ENERGY SAVING LAMPS & HOLDERS

Energy Saving Compact Fluorescent Lamps • 8000 hrs



PL-7-CW

Code	Wattage	Base	Length	Base Code
2 Pin type Inline				
PL-7-*	7W	G23	137mm	BCF-G23
PL-9-*	9W	G23	167mm	BCF-G23
PL-9-CW 110V	9W	G23	167mm	BCF-G23
PL-11-*	11W	G23	237mm	BCF-G23
PL-13-*	13W	G23	188mm	BCF-G23



BCF-G23



PLC-26-CW

Code	Wattage	Base	Length	Base Code
2 Pin Type Off Centre				
PLC-13-*	13W	G24d1	130mm	BCF-G24d1
PLC-18-*	18W	G24d2	152mm	BCF-G24d2
PLC-26-*	26W	G24d3	167mm	BCF-G24d3

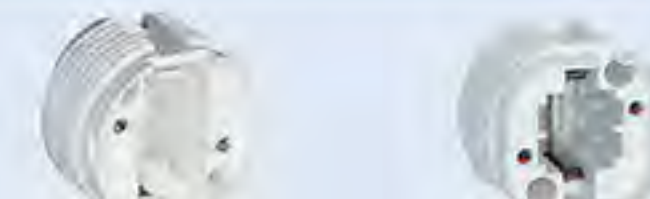

BCF-G24d



PLCE-13-CW

Code	Wattage	Base	Length	Base Code
4 Pin Type				
PLCE-13-*	13W	G24q1	132mm	BCF-G24q1
PLCE-18-*	18W	G24q2	144mm	BCF-G24q2
PLCE-26-*	26W	G24q3	165mm	BCF-G24q3
PLCE-42-*	42W	G24q4	168mm	BCF-G24q4



BCF-G24q

*Add to code: ○ WW (Warm White, 2700K), ○ CW (Cool White, 4000K)

ENERGY SAVING LAMPS - TUBULAR



Tubular - 15000 hours lifetime 220-240VAC

Code Warm White	L(mm)	Watts	Base	Colour	Code Cool White	Watts	Base	Colour
SU207-E14-WW	103	7W	E14	2700K	SU207-E14-CW	7W	E14	4000K

ENERGY SAVING LAMPS



CFL	→	GLS
9W	→	45W
11W	→	60W
15W	→	75W
20W	→	100W

Globe Compact Fluorescent Lamp - Replacement for Standard Incandescent Globe 230VAC

Code E27	Code B22	Watts	Length	Lumen
ES-A60-E27-11-*	ES-A60-B22-11-*	11W	110mm	500lm
ES-A60-E27-15-*	ES-A60-B22-15-*	15W	120mm	800lm
ES-A60-E27-20-WW	ES-A60-B22-20-*	20W	130mm	1000lm

*Add colour to code: ○ WW (Warm White), ○ CW (Cool White)



Candle Light Compact Fluorescent Lamps - 230VAC

Code E14	Code E27	Code B22	Watts	Length	Lumen
-	ES-CDL-E27-5-*	-	5W	98mm	200lm
-	ES-CDL-E27-7-*	ES-CDL-B22-7-*	7W	98mm	280lm
ES-CDL-E14-9-*	ES-CDL-E27-9-*	ES-CDL-B22-9-CW	9W	108mm	380lm
-	-	-	5W	125mm	180lm
FE38-7-E14-WW	-	-	7W	125mm	280lm
FE38-9-E14-WW	-	-	9W	135mm	380lm
FE40-5-E14-G	-	-	5W	125mm	180lm
FE40-7-E14-G	-	-	7W	127mm	300lm

*Add colour to code: ○ WW (Warm White), ○ CW (Cool White)

Large Size Candle Light Compact Fluorescent Lamps - 230VAC

-	FE36-5-E27-WW	-	5W	149mm	180lm
FE36-7-E14-WW	-	FE36-7-B22-WW	7W	149mm	280lm
FE36-9-E14-WW	FE36-9-E27-WW	-	9W	169mm	380lm
-	FE36-11-E27-WW	FE36-11-B22-WW	11W	169mm	500lm



Golf Ball Compact Fluorescent Lamp - 230VAC

GA607-E14-*	GA607-E27-*	GA607-B22-*	7W	89mm	-
-------------	-------------	-------------	----	------	---

*Add colour to code: ○ WW (Warm White), ○ CW (Cool White), ● R (Red), ● GN (Green), ● Y (Yellow)



Spiral Compact Fluorescent Lamp - 230VAC

-	FE35-15-E27-*	FE35-15-B22-*	15W	128mm	701lm
---	---------------	---------------	-----	-------	-------

*Add colour to code: ○ WW (Warm White), ● O (Orange)



Mosquito Repelling Lamp - 230VAC

Code	Description	Length
RDZ-15-25B-MOS	15W E27	135mm



Dimmable range 15 000 hours lifetime 220-240VAC

Dimmable to 4 preset levels

Code	Watts	Base	Colour Temp.	Length
GK715S	15W	E27	2700K	128mm

4-step dimming (100%-66%-33%-5%)

4-Step Dimming - Every Dimmable Compact Fluorescent switching OFF/ON will activate the dimming program of the lamp. The brightness of the lamp can be adjusted from 100% to 66%, 33% or 5% with consecutive switching OFF/ON action within 1 second.

ENERGY SAVING LAMPS

Energy Saving Compact Fluorescent Lamps 230VAC - Warm white - 2700K; Cool white - 4000K



Code E27	Code B22	Watts	Length	Lumen
FE1-7-E27-WW	-	7W	135mm	238lm
FE1-9-E27-WW	FE1-9-B22-WW	9W	136mm	367lm
-	FE1-11-B22-WW	11W	146mm	449lm
For E14 replace B22 with E14				
FE27-20-E27-WW	-	20W	155mm	935lm
FE27-20-E27-WW/10 (PACK OF 10)	-	20W	155mm	935lm
-	FE27-25-B22-WW	25W	172mm	1360lm
FE35-11-E27-WW	FE35-11-B22-WW	11W	122mm	449lm
FE35-20-E27-WW	FE35-20-B22-WW	20W	141mm	935lm
-	FE35-26-B22-WW	26W	165mm	1326lm
-	FE10-11-B22-WW	11W	Ø90mm	443lm
-	FE10-16-B22-WW	16W	Ø100mm	695lm
-	FE10-18-B22-WW	18W	Ø100mm	833lm
-	FE10-24-B22-WW	24W	Ø120mm	1105lm
FE29-9-E27-*	FE29-9-B22-*	9W	152mm	360lm
FE29-11-E27-*	FE29-11-B22-CW	11W	152mm	443lm
FE50-15-E27-*	FE50-15-B22-*	15W	164mm	695lm
-	FE32-22-B22-WW	22W	Ø210mm	1900lm
-	FE16-20-B22-WW	20W	170mm	895lm
-	FE18-S11-B22-WW	11W	109mm	550lm
-	FE18-S20-B22-*	20W	144mm	1080lm

*With daylight sensor. Supply Voltage 230VAC

Reflective Type



Code E27	Code B22	Watts	Type	Lumen
FE66-11-E27-WW	FE66-11-B22-WW	11W	R80	449lm
ERF-15-E27-CW	ERF-15-B22-CW	15W	R80	701lm
ERB-20-E27-CW	-	20W	PAR38	935lm
ERB-25-E27-CW	-	25W	PAR38	1265lm

PAR56

Code	Lamp Base	Watts	Type	Lumen
LUXPAR56-*	GU10	23W	PAR56	980lm

*Add colour to code: ○ CW (Cool White), ○ WW (Warm White)



GU10 CFL 12000hrs - Not Dimmable 220-240VAC

Watts	Warm White 2700K	Cool White 4000K	Daylight 6500K	Lens	Length
7W	SP2007-WW	SP2007-CW	-	Diffused	68mm
9W	SP2009-WW	SP2009-CW	SP2009-DL	Diffused	78mm
11W	SP20011-WW	SP20011-CW	SP20011-DL	Diffused	84mm
13W	SP20013-WW	SP20013-CW	SP20013-DL	Diffused	86mm



R50/E14 CFL 15000hrs

Watts	Warm White 2700K	Cool White 4000K	Lens	Length
7W	BR0107-WW	BR0107-CW	Clear	-

Accessory

Code	Description
MM166	Reflector for BR0107 Ø80 x 54H (mm)

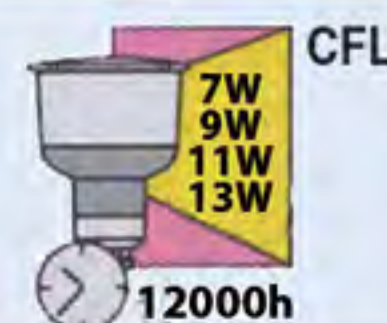

MR16/GU5.3 12000hrs - 220-240VAC

Watts	Warm White 2700K	Cool White 4000K
7W	LUX240-7-WW	LUX240-7-CW
9W	LUX240-9-WW	LUX240-9-CW
11W	LUX240-11-WW	LUX240-11-CW



MR16/GU5.3 8000hrs - 12VAC/DC

Watts	Warm White 2700K	Cool White 4000K
7W	KS-MR16-7-WW	KS-MR16-7-CW
9W	KS-MR16-9-WW	KS-MR16-9-CW
11W	KS-MR16-11-WW	KS-MR16-11-CW



Cat's Eye Glo-in-the-dark Lamps

Code	GSU11-IAG
Watts	11W
Base	E27

Lamp will glow in the dark for approximately 20 min after it has been switched off

DC ENERGY SAVING LAMPS



DC Lamps 8000 Hour Life

Code E27 	Code B22 	Watts	Lumen	Length (H)
FE1-7-E27**	FE1-7-B22**	7W	238lm	124mm
FE1-9-E27**	FE1-9-B22**	9W	367lm	136mm
FE1-11-E27**	FE1-11-B22**	11W	449lm	146mm
FE27-15-E27-WW*	FE27-15-B22**	15W	701lm	139mm
FE27-20-E27**	FE27-20-B22**	20W	935lm	164mm
-	FE36-5-B22-W*	5W	180lm	108mm
-	FE36-7-B22-W*	7W	270lm	108mm
-	FE36-9-B22-W*	9W	400lm	117mm
-	FE36-11-B22-W*	11W	500lm	136mm

*Supply Voltage: 12VDC, 24VDC | *Add "-CW" for Cool White or "-WW" for Warm White

DC Lamps 15000 Hour Life

CF1-9-E27-12VDC	-	9W	367lm	140mm
-----------------	---	----	-------	-------

ENERGY SAVING LAMPS & FITTINGS

Classic – 15000 hours lifetime 220-240VAC



Code Warm White	L (mm)	Watts	Base	Colour	Code Cool White	Watts	Base	Colour
-	-	-	-	-	GSU109-E27-CW	9W	E27	4000K
GSU520-E27-WW	140	20W	E27	2700K	GSU520-E27-CW	20W	E27	4000K
-	-	-	-	-	GSU109-B22-CW	9W	B22	4000K
GSU111-B22-WW	113	11W	B22	2700K	GSU111-B22-CW	11W	B22	4000K
GSU515-B22-WW	116	15W	B22	2700K	GSU515-B22-CW	15W	B22	4000K

PAR's

- CW (Cool White),
- WW (Warm White)
- W (Warm White),
- GN (Green)



AR111 CFL Aluminium Reflector - Replaced AR111 Halogen Lamps 12000hrs | Supply Voltage 220-240VAC



Code	BR0111-*	BR0620-*	Warm White 2700K	Cool White 4000K	Watts	Base	Type	Replaces Halogen
Size	E27/R63	E27/PAR38	LUXES111-WW	LUXES111-CW	11W	GU10	Spot (60°)	75W
Watts	11W	20W	EF-AR111-WW	EF-AR111-CW	20W	GU10	Flood (105°)	50W
*Add colour to code:	WW / CW	W / GN						

G9 Energy Saving Lamps 10 000 hours

Supply Voltage 220-240VAC

Code	Watts	Base	Lumen	Length
S-AE-7-*	7W	G9	445	69mm
S-AE-9-*	9W	G9	585	75mm

* Add 'CW' for Cool White or 'WW' for Warm White
Perfect replacement for hot G9 lamps
Diameter of lamp: 37mm
Produces less heat and consumes less energy



Mini-twist Energy Saver 9W



Code	MHS9W-GU10-WW
Watts	9W
Base	GU10
Length	90mm

Self Ballasted Plug-in Lamp 10 000 hours 220-240VAC



Code	Watts	Base	Lumen	Length
S-AF-10-*	10W	G24d-1	530	105mm
S-AF-13-*	13W	G24d-1	700	112mm
S-AF-18-*	18W	G24d-2	950	123mm
2U-R-10-*	10W	G24d-1	500	127mm
2U-R-13-*	13W	G24d-1	650	137mm
2U-R-18-*	18W	G24d-2	900	147mm
3U-R-26-WW	26W	G24d-3	1300	167mm

* Add 'CW' for Cool White or 'WW' for Warm White

HALOGEN CAPSULE LAMPS

Halogen Lamps - Colour Temp: 2900K | Some supplied with 2 per pack as shown in code /2



Halogen Code	Watts	Voltage	Base Type	Luminous Intensity (lm)	Size L x Ø (mm)
JCD-50/2	50W	220-240V	G6.35	600	45 x 13
JCD-100/2	100W	220-240V	G6.35	1200	54 x 13
JCD-150	150W	220-240V	G6.35	2100	54 x 13
JD-100	100W	220-240V	BA15d	1150	75 x 14



Halogen Flood Lamps - Replacement for Incandescent Reflector Lamps | Beam Angle 30°

Code	Watts	Voltage	Base Type	Luminous Intensity (lm)	Size L x Ø (mm)
PAR16FL	50W	220-240V	E27	250	75 x 51
PAR20FL	50W	220-240V	E27	350	80 x 64.5

DICHROIC LAMPS

Halogen Lamp 2000-3000hrs Colour Temp K = 2900 *Xenon Lamp 12V 8000hrs • Xenon Lamp (GU) 230V 5000hrs



**Xenon
Extends
Life
8000hrs**

Halogen Code	Watts	Voltage	Base Type	Beam Angle	Luminous Intensity (lm)	*Xenon Code
Open Type *XMR16 Xenon Lamp not available in 230V and 24V. Only 12V						
MR11-20/2	20W	12V	GU4/GZ4	30°	1100	-
MR16-20/2	20W	12V	GU5.3	36°	500	-
-	35W	12V	GU5.3	36°	850	XMR16-35 *12V
-	50W	24V	GU5.3	36°	1550	*XMR16-50
GU10-35*	35W	230V	GU10	30°	600	XGU10-35
GU10-50	50W	230V	GU10	30°	1000	XGU10-50

*Add /2 for pack of 2

Closed Type *XMR16 Xenon Lamp not available in 230V and 24V. Only 12V						
MR11S-20	20W	12V	GU4	30°	1100	-
MR16S-20*	20W	12V	GU5.3	36°	500	-
MR16S-35*	35W	12V	GU5.3	36°	850	-
MR16S-50*	50W	24V/230V	GU5.3	36°	1550	-
GU10S-35*	35W	230V	GU10	30°	600	XGU10S-35

*Add /2 for pack of 2

Closed Type Coloured Lens						
MR16S-20*	20W	12V	GU5.3	24°	950	-
MR16S-35*	35W	12V	GU5.3	24°	1800	-
MR16S-50*	50W	12V	GU5.3	24°	3000	-

*Add Colour of Lens to Code: ● R (Red), ● G (Green), ● Y (Yellow), ● B (Blue) or ● P (Purple)

T8 to T5 CONVERSION

Convert your existing T8 Light Fittings to Energy Saving T5

- CW - 4000K
- DL - 6000K

without reflector



with reflector



1. Wiring diagram for retrofit into fluorescent fitting with electronic ballast

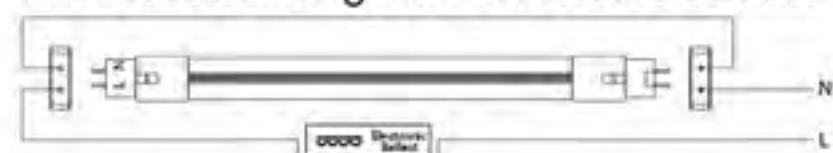

2. When tube is replaced in a standard fluorescent fitting with magnetic ballast

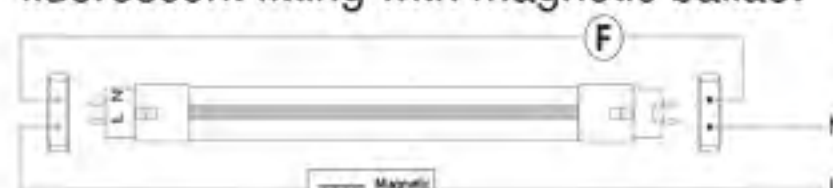

EL-FL fuse link

T8-T5 Conversion - No Reflector. (Supplied with lamp) PF:0.9

Code	To Fit T8	T5 Power	Size	Replacement Lamp	Colours
EL-T8/T5-14W-DL	2ft-18W	14W	588 x 24 x 35mm	FLT5-14W	DL
EL-T8/T5-21W-CW	3ft-30W	21W	892 x 24 x 35mm	FLT5-21W	CW
EL-T8/T5-28W-*	4ft-36W	28W	1197 x 24 x 35mm	FLT5-28W	CW / DL
EL-T8/T5-35W-*	5ft-58W	35W	1498 x 24 x 35mm	FLT5-35W	CW / DL

T8-T5 Conversion - With Reflector. (Supplied with lamp) PF:0.9

Code	To Fit T8	T5 Power	Size	Replacement Lamp	Colours
ELR-T8/T5-14W-CW	2ft-18W	14W	588 x 45 x 35mm	FLT5-14W	CW
ELR-T8/T5-21W-CW	3ft-30W	21W	892 x 45 x 35mm	FLT5-21W	CW
ELR-T8/T5-28W-CW	4ft-36W	28W	1197 x 45 x 35mm	FLT5-28W	CW
ELR-T8/T5-35W-*	5ft-58W	35W	1498 x 45 x 35mm	FLT5-35W	CW / DL

Accessories

Code	Description
EL-FL	Fuse link to replace starter in switch start fittings

For retrofit into switch start fittings Power Factor capacitor should be removed and fuse link used instead of starter. For retrofit into electronic fittings rewiring is required. Please contact technical call centre for more information and wiring diagrams.

LED FLOODLIGHTS

3 Year Warranty



LED General Floodlights - IP65 | Supply Voltage: 120-265VAC | Beam Angle 120° | SMD Chipsets | Designed for general applications

Code	Wattage	Lumens	Size (mm)	Spare Driver
GY225TG-10W-*	10W	900lm	125 x 120 x 45	DRV-GY225TG-10W
GY225TG-20W-*	20W	1800lm	200 x 180 x 45	DRV-GY225TG-20W
GY225TG-30W-*	30W	2700lm	200 x 225 x 50	DRV-GY225TG-30W
GY290TG-40W-*	40W	3600lm	270 x 280 x 80	DRV-GY290TG-40W
GY290TG-50W-*	50W	4500lm	270 x 280 x 80	DRV-GY290TG-50W
GY370FG-60W-*	60W	5400lm	316 x 235 x 65	DRV-GY370FG-60W
GY370FG-70W-*	70W	6300lm	375 x 290 x 75	DRV-GY370FG-70W
GY470TG-80W-WW	80W	7100lm	375 x 290 x 75	DRV-GY470TG-80W
GY470TG-100W-*	100W	9000lm	375 x 290 x 75	DRV-GY470TG-100W
GY490TG-150W-*	150W	14500lm	455 x 330 x 95	DRV-GY490TG-150W
GY490TG-200W-*	200W	18000lm	455 x 330 x 95	DRV-GY490TG-200W

*Add colour to code: ○ **WW** (Warm White) 3000K, ○ **CW** (Cool White) 5500-6000K

5 Year Warranty



LED High Quality Floodlights - IP65 | Supply Voltage: 85-265VAC | LED Floodlights above 100W are supplied with Meanwell Drivers | Designed for industrial applications

Code	Wattage	Lumens	Size (mm)	Spare Driver
GY480TG-100W-*	100W	9000lm	350 x 300 x 70	DRV-GY480TG-100W
GY480TG-150W-*	150W	18000lm	450 x 348 x 60	DRV-GY480TG-150W
GY480TG-200W-CW	200W	24000lm	450 x 348 x 60	DRV-GY480TG-200W
GY480TG-400W-*	400W	40000lm	620 x 500 x 125	DRV-GY480TG-400W
GY570FG-120W-*	120W	12000lm	593 x 285 x 93	DRV-GY570FG-120W
GY670S-150W-*	150W	15000lm	451 x 311 x 202	DRV-GY670S-150W
GY670S-180W-*	180W	18000lm	451 x 311 x 202	DRV-GY670S-180W
GY670S-200W-*	200W	20000lm	525 x 365 x 185	DRV-GY670S-200W
GY670S-320W-*	320W	32000lm	525 x 365 x 185	DRV-GY670S-320W
GY670S-400W-*	400W	40000lm	580 x 320 x 190	DRV-GY670S-400W

*Add colour to code: ○ **WW** (Warm White) 3000K, ○ **CW** (Cool White) 5500-6000K

LED Narrow Beam Floodlights - IP65 | Input Voltage: 90-265VAC | Beam Angle: 10° | Colour Temp.: 6500K



Code	Wattage	Lumens	Size (mm)
SS-FL-80W	80W	7000lm	240 x 285 x 150
SS-FL-100W	100W	8400lm	300 x 285 x 150
SS-FL-120W	120W	10700lm	360 x 285 x 150

LED Asymmetrical Floodlights - IP65 | Input Voltage: 170-240VAC | Colour Temperature: 6500K | Concentrated Beam Angle | Suitable for Sports & Area Lighting



Code	Wattage	Lumens	Size (mm)
NP-FL03-80W	80W	6400lm	255 x 87 x 290
NP-FL03-100W	100W	8000lm	255 x 87 x 290

LED FLOODLIGHTS



LED Adjustable Floodlights - IP65 | Input Voltage: 85-265VAC | Colour Temp.: 6500K | LED Modules are Adjustable | Working Temperature -40°C - +60°C

Code	Wattage	Lumens	Size (mm)
CE33-DL	40W	4200lm	238 x 102 x 178
CE37-DL	80W	8400lm	238 x 102 x 178
CE46-DL	160W	6800lm	425 x 219 x 227

LED SPOT LIGHT IP65



Input Voltage: 230VAC

Code	Wattage	Lumens	Size (mm)
ZL-L3222P-*	28W	2380lm	260 x 272 x 86
ZL-L3222L-*	30W	2300lm	260 x 272 x 86
ZL-L3223A-CW	80W	1100lm	190 x 278 x 86
NLG08-08A-*	24W	2000lm	230 x 354
GY290TS-30W-*	30W	2400lm	290 x 236 x 206
GY290TS-40W-*	40W	3200lm	290 x 236 x 206
GY290TS-50W-*	50W	4000lm	290 x 236 x 206

*Add colour to code: ○ WW (Warm White) 3000K, ○ CW (Cool White) 5500-6000K

PORTABLE LIGHTS C/W BATTERY

CFL - IP65 | Lamps included | Rechargeable | Material: Plastic



Code	Wattage	Battery Type	Working Time	Colour Temp
E84W/24A	2 x 42W (CFL)	24Ah Sealed Lead acid	1 lamp:7hrs/2 lamp:3.5hrs	DL (6000K)
E84W/24A-E	2 x 42W (CFL)	24Ah Sealed Lead acid	1 lamp:7hrs/2 lamp:3.5hrs	DL (6000K)

LED - IP65 | Lamps included | Rechargeable | Material: Aluminium

E2410-30	30W (LED)	10Ah Li-Ion	7hrs	DL (6000K)
----------	-----------	-------------	------	------------

Explosion Proof - IP65 | c/w wheels & 2 light levels selectable | Material: Aluminium Alloy | Ex de II C T6

FLP

BW3210	30W (LED)	12Ah Sealed Lead acid	High: 16hrs / Low: 36hrs	DL (6000K)
--------	-----------	-----------------------	--------------------------	------------

LED Mobile Emergency Lighting in Case IP67 - Colour Temp: 6500K | c/w Built-In Charger | c/w Batteries | c/w Wheels for easy transportation



Code	5JG-RL9972	RLS512722-72W	RLS584433-144W
Lamp Power	36W	72W	144W
Lumen (High/Med/Low)	2100/1255/884lm	4000/2000/1500	8000/4000/2000
Total Weight	14.5kg	22kg	32kg
Battery Type	12V 10Ah Lithium	12V 24Ah	12V 33Ah
Working Time hrs	33hrs (low)/17hrs (med)/8hrs (high)	26hrs (low)/14hrs (med)/7hrs (high)	28hrs (low)/16hrs (med)/8hrs (high)
Charge Time	5.5hrs	6-8hrs	6-8hrs
Spare Battery Code	RLS-963L-BAT	RLS512722-BAT	RLS584433-BAT

LED BILLBOARD LIGHTS IP65

SOL2 SOLAR

Solar Billboard Floodlight - Colour Temperature: 5500K | Working Hours: 4-6Hrs, 3-5Hrs (Rainy Day) | Charging Time: 6-8Hrs | Life PO4 Battery

Code	Solar Panel	Light Source	Lumen	Size (mm)	Weight (Kg)
LFA-24W	18V / 60W	24W CREE LED	2640lm	1155 x 355 x 185	23
LFA-36W	18V / 60W	36W CREE LED	3960lm	1155 x 480 x 185	35

LED

- 230VAC
- c/w arm



LED Billboard Floodlight - Input Voltage 230VAC | c/w Mounting Arm

Code	Power	Lumen	Size (mm)
ZL-L3221PB-*	12W	1020lm	190 (wide) x 835 (incl. arm)
ZL-L3221QB-*	20W	1700lm	190 (wide) x 835 (incl. arm)

*Add colour to code: ○ **CW** (Cool White) 4200K, ○ **WW** (Warm White) 2700-3000K

FLOODLIGHTS - INDUCTION IP65



Code	EDC- [*] -DL	VF- [*] -DL	JM-JN- [*]
*Add watts to code	80W, 100W	200W, 300W	80W, 120W, 200W
lm/W	80lm	80lm	80lm
Colour Temp	5000-5500K	5000-5500K	6500K
Size (mm)	450 x 450 x 155	Ø430 x H350	440 x 410 x 140

ENERGY SAVING FLOODLIGHTS

Lamp supplied: Daylight 6500K.
For spare lamps, see page 20



DF-65CFL

DF-180CFL

Energy Saving Floodlights - c/w lamp 230VAC

Code	Watts	Lamp Holder	Light Fitting	Lamp Code	Size (mm)
DF-30CFL	30W	E27	-	-	270 x 202 x 132
DF-45CFL	45W	E40	F2012	-	395 x 224 x 165
DF-065CFL	65W	E40	-	ESL42-65-E40-D	410 x 300 x 139
DF-105CFL	105W	E40	-	-	410 x 300 x 139
DF-125CFL	125W	E40	FL1028	ESL42-125-E40-D	580 x 475 x 168

Lamp supplied: Daylight 6500K

DF-150CFL	150W	E40	FL1028	ESL42-150-E40-D	580 x 475 x 168
DF-180CFL	180W	E40	FL1028	ESL42-180-E40-D	580 x 475 x 168
DF-200CFL	200W	E40	FL1028	ESL42-200-E40-D	580 x 475 x 168

Energy Saving Floodlights - Lamp to be ordered separately. See page 18-19



LD3001-2X26W

LD3001-4X26W

LD3001-51

Code	Lamp Holder	Watts	Size(mm) H x W x D	Lamp Type
LD3001-2X26W	G24q3	2 x 26W	290 x 240 x 115	PLCE-26-CW
LD3001-4X26W	G24q3	4 x 26W	450 x 325 x 130	PLCE-26-CW

Empty Floodlights - Lamp to be ordered separately. See page 20.

LD3001-50	E27	70W	290 x 240 x 115	ESL42-45-E27-S-M
LD3001-51	E40	150W	400 x 325 x 130	ESL42-65-E40-S-M
LD3001-52	E40	400W	400 x 420 x 170	ESL42-150-E40-D

PLASTIC ENERGY SAVING FLOODLIGHTS



Lamps excluded

Floodlight - IP65 | Input Voltage: 230VAC | Material: High Strength Plastic
C/W Cool White Lamp 4000K | Lamps Excluded

Code	Wattage	SIZE
BL070	2x 23W	260 x 260 x 105

LED FLOODLIGHTS

NEW



C2440-GW-18-DL

C2440-HW-36-DL

LED PIR Motion Sensor Floodlight IP65 - Colour Temp: 5000K | 180° Adjustable Head | 180° Motion Detection | 4 Smart Working Modes: Auto, On-time, Dusk to Dawn, Test mode | Adjustable Sensing Features, Lux, Time and Range

Code	Wattage	Lumens	Size (mm)
C2440-GW-18-DL	18W	1800lm	227 x 190 x 179
C2440-HW-36-DL	36W	3600lm	231 x 188 x 183



5 Year Warranty

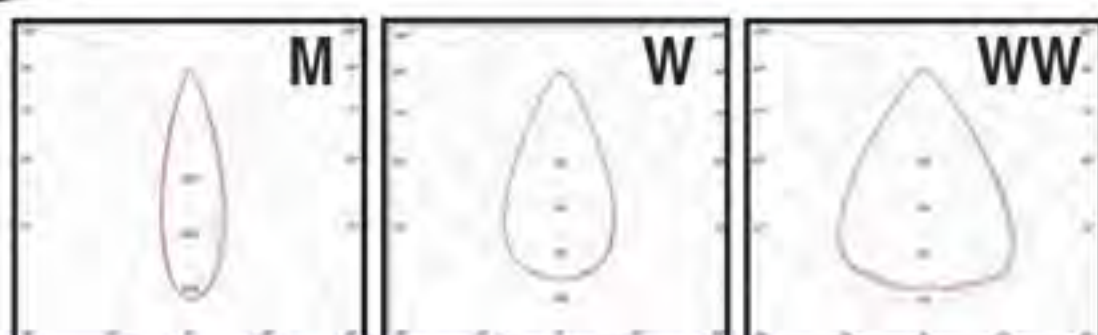

LED Vega Project Floodlight - IP65 Input Voltage: 170-264VAC | Over Voltage Protection: 320VAC, 48h | PF .97 | Colour Temperature: 5000K | Beam Angles: 13° / 24° / 52° | Burst / Surge 10kV

Code	Wattage	Lumens	Size (mm)
VEGA-4-*	136W	16730lm	260 x 100 x 260
VEGA-5-*	170W	20900lm	260 x 100 x 340
VEGA-6-*	204W	25090lm	260 x 100 x 400
VEGA-7-*	238W	29270lm	260 x 100 x 460
VEGA-8-*	272W	33450lm	260 x 100 x 520
VEGA-9-*	306W	37600lm	260 x 100 x 580

* Add beam Angle to Code: **M**(13°), **W**(24°), **WW**(52°),

LED SPORT FLOODLIGHTS

5 Year Warranty



Dragon Stadium Floodlight - IP66 - Input Voltage: 100-277VAC | 5700K | 150lm/W | L70B10 50000hrs | 360° Rotatable Module | Tempered Glass, PMMA Lens | Ideal for Sport fields & Stadiums

Code	Wattage	Lumens	Beam Angle	Size (mm)
B-240W-30-DL	240W	36 000lm	30°	745 x 332 x 172
B-500W-30-DL	500W	75 000lm	30°	745 x 594 x 172
B-800W-30-DL	800W	120 000lm	30°	745 x 817 x 172
B-1000W-40-30-DL	1000W	150 000lm	30°	911 x 1125 x 181
B-1500W-40-30-DL	1500W	225 000lm	30°	1139 x 1125 x 181



LED HIGHBAYS IP65

5 Year Warranty

130 lm/w



High Power LED Highbay - IP65 | Input Voltage: 100-277VAC | Philips 3030 | 80° Beam Angle | Meanwell Driver | Operational Temperature: 40 ~ 60°C | Colour Temperature: 5500K | CRI > 80

Code	Wattage	Lumens	Size (mm)
BR-HBL-300W	300W	40 000lm	Ø460 x 262
BR-HBL-400W	400W	54 000lm	Ø460 x 347
BR-HBL-500W	500W	65 000lm	Ø460 x 315

Standard - Input Voltage: 100-277VAC | Colour Temp. 6000K | Material: Aluminium Alloy | High Quality Chipset for Superior Light Output | Available as Surface or Recess Mount



CYZ-100-R - Recessed

Code	Wattage	Lumens	Size (mm)	Cut-out Size (mm)
CYZ-100-R	100W	11000lm	420 x 420 x 160	360 x 360
CYZ-100-S	100W	11000lm	420 x 420 x 160	-

LED HIGHBAYS IP65

5 Year Warranty



Narrow Angle - Supply Voltage: 85-265VAC | Working Life: 50 000hrs | Power Factor: > 0.95 | Recommended Mounting Height +12m | Applicable for Workshops, Factories, Storage, Supermarkets, Shops

Code	Watts	Lumens	Colour Temp.	Beam Angle	Dimensions	Weight
LQ-ILH-200	200W	20000lm	6000K	60°	Ø367 x 459	11kg
LQ-ILH-300	300W	30000lm	6000K	60°	Ø367 x 470	11,5kg

- WW - 2700K
- CW - 4200K
- DL - 6000K



FLP



Explosion Proof Light - Supply Voltage: 85-265VAC | 120° Beam Angle.

Code	* Add Watts to Code	Luminous Efficiency	Size (mm)	*Add Colour to Code
SEM-HG-**-*	50W, 70W, 100W, 120W	100lm/W	Ø295 x 164	WW / CW / DL

- WW - 2700K
- CW - 4200K
- DL - 6000K



Weatherproof Light - Supply Voltage: 85-265VAC | 120° Beam Angle.

Code	* Add Watts to Code	Luminous Efficiency	Size (mm)	*Add Colour to Code
JR-GK10-**-*	50W, 70W, 100W, 120W	100lm/W	Ø295 x 164	WW / CW / DL

3 Year Warranty

Please note that LED Head and Reflectors are to be ordered separately!

LED High Bays - Recommended Mounting Height 4-10m | Supply Volts: 100-240VAC | CRI: 75(cw), 80 (ww) | Working Temp: -40-65°C | Aluminium Reflectors available in two Beam Angles | High Quality Meanwell Drivers



Wattage	Lumen	LED Head	Reflector 120°	Reflector 45-60°	Weight Inc.Ref
50W	4750lm	HB-LED-50W-*	HB-AL120-50W	HB-AL4560	4.1kg
100W	9500lm	HB-LED-100W-*	HB-AL120		6.1kg
120W	11400lm	HB-LED-120W-*			6.1kg
150W	14250lm	HB-LED-150W-CW	HB-AL120L	HB-AL4560L	8.3kg
200W	19000lm	HB-LED-200W-*			7.2kg

*Add colour to code: ○ CW (Cool White) 4200K, ○ WW (Warm White) 3000K.

3 Year Warranty



High Power LED Highbays - Supply voltage: 85 - 265VAC | Colour Temp: 4000K | CRI > 80 | Working Temp: -25°C to +60°C | Bridgelux Chipset

Code 45-60° Reflector	Code 120° Reflector	Watts	Lumens	Size
HB-L4560D-30W-CW	HB-L120D-30W-CW	30W	2850lm	Ø410 x 500
HB-L4560D-50W-CW	HB-L120D-50W-CW	50W	4750lm	Ø410 x 500
HB-L4560D-100W-CW	HB-L120D-100W-CW	100W	9500lm	Ø410 x 510
HB-L4560D-150W-CW	HB-L120D-150W-CW	150W	14250lm	Ø480 x 620
-	HB-L120D-200W-CW	200W	19000lm	Ø480 x 650

SHALLOW BOWL INDUCTION HIGH BAY LIGHT

Supply Voltage:
180-260VAC
6000K



c/w glass bowl



c/w glass bowl

Accessories



Code	GDD-N-*	GDD-V-*	Code	GDD-BGLASS
*Add watts to code	150W, 200W, 250W	150W, 200W, 250W	Description	Spare glass bowl
Luminous Efficiency	80lm/W	80lm/W		
Beam Type	Wide	Narrow		
Reflective Coating	Nano-coating	Vacuum Coating		
Size 	Power (W)	Ø (mm)	H (mm)	
	150	Ø470	432	Code
	200	Ø506	445	GDD-BACR
	250	Ø556	462	Description
				Spare Acrylic bowl

INDUCTION HIGH BAYS

Reflectors for Induction High Bays

Polycarbonate. Supplied c/w white collar



Complete fitting

Bowl Cover

Reflectors for Induction High Bays - Aluminium



Bowl Cover

c/w glass bowl cover & fixing clips

Control Gear IP43

Supply Voltage:
180-260VAC



Size	Lamp Size	Reflector	Bowl Cover	Reflector	Bowl Cover	Reflector	Code	CHG-GB-*
410mm	80 - 200W	PCR-410	NBC114-2	-	-	-	*Add power to code	80W, 100W, 120W, 150W, 200W, 250W
485mm	80 - 200W	-	-	ALR-485	RW-AL485	-	Material	Die Cast Aluminium
505mm	80 - 250W	-	-	-	-	ALR-505SH	Description	Gear box with built in ballast for induction lamp
570mm	250W	PCR-570	NBC114-4	ALR-570	RW-AL570	-		

To put together a complete fitting order: 1x Reflector, 1x Control Gear, 1x Lamp

INDUCTION BALLASTS

Ballasts for Low Frequency Induction Lamps

PF: 0.99. Operating Temperature: -35°C to 50°C. Frequency: 230kHz ±30

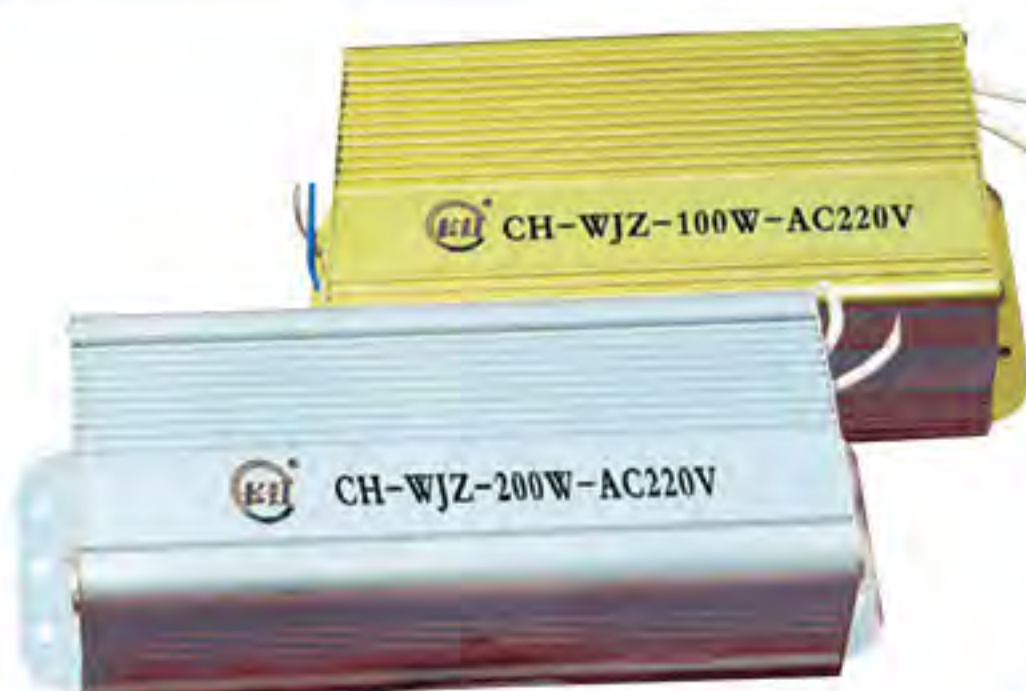

Code	Size L x W x H	Supply Volts
CH-WJZ-80W	191 x 100 x 56mm	180-260VAC
CH-WJZ-150W	191 x 100 x 56mm	180-260VAC
CH-WJZ-200W	206 x 110 x 56mm	180-260VAC
CH-WJZ-300W	206 x 110 x 56mm	180-260VAC

INDUCTION LAMPS

Low-Frequency Induction Lamps - Supply volts 160-260VAC | PF: 0.98 | Quick starting | CRI: 80 | Ballast to be ordered separately

- WW - 2700K
- CW - 4000K
- DL - 6000K



Rectangular



IN-AD



Code [^]	Lamp Size	Code	Lamp Size	Lamp Power	Lumen	*Add colour to Code
CH-HX-80W-*	225 x 215 x 78mm	CH-JX-80W-*	300 x 142 x 78mm	80W	6000-6400lm	WW / CW / DL
CH-HX-100W-*	225 x 215 x 78mm	CH-JX-100W-*	300 x 142 x 78mm	100W	7500-8200lm	WW / CW / DL
CH-HX-120W-*	305 x 275 x 78mm	CH-JX-120W-*	370 x 142 x 78mm	120W	9225-9840lm	WW / CW / DL
CH-HX-150W-*	340 x 295 x 79mm	CH-JX-150W-*	410 x 142 x 78mm	150W	11475-12699lm	WW / CW
CH-HX-200W-*	355 x 315 x 89mm	CH-JX-200W-*	500 x 150 x 90mm	200W	15000-17000lm	WW / CW / DL
CH-HX-250W-*	420 x 395 x 90mm	CH-JX-250W-*	550 x 155 x 90mm	250W	18750-21250lm	WW / CW / DL
CH-HX-300W-*	430 x 400 x 90mm	CH-JX-300W-*	550 x 160 x 90mm	300W	22500-28050lm	WW / CW / DL

[^]Includes IN-AD lampholder adaptor for use in high bay fittings.

LED LINEAR HIGHBAYS

NEW 5 Year Warranty

140 lm/w



Linear Highbay - IP66

Input Voltage 85-265VAC | 140lm/W | 5500K | 1-10V Dimmable | 240° Beam Angle | Frosted Diffuser | Applications: Airport, Parking Garages, Industrial Warehouses, Gymnasiums

Code	Wattage	Lumens	Size (mm)
IK-LHB-80W	80W	11200lm	600 x 154 x 70
IK-LHB-150W	150W	21000lm	1200 x 154 x 70
IK-LHB-200W	200W	28000lm	1500 x 154 x 70
IK-LHB-240W	240W	33600lm	1500 x 154 x 70

5 Year Warranty



Typhoon LED Highbay - IP65 | Supply voltage: 100-277VAC | 160lm/W | Colour Temp 6000K | Adjustable lens 60°, 85°, 110° | Supplied without microwave sensor

Code	Wattage	Lumens	Size (mm)
YT-LEDH33-100W	100W	15500lm	Ø338 x 178mm
YT-LEDH33-150W	150W	23250lm	Ø338 x 178mm
YT-LEDH33-200W	200W	31000lm	Ø338 x 178mm

Accessories

Code	Description
YT-HD03R	Remote Control / Remote can set multiple Highbays
YT-LEDH33-MS	Microwave Sensor
YT-LEDH33-PCD	PC Diffuser Reflector with Mounting Accessories
YT-LEDH33-PCC	PC Bowl Cover for Diffuser with Mounting Accessories
YT-LEDH33-BR01	Mounting Bracket for 100W, 150W & 200W

YT-HD03R

YT-LEDH33-PCC



YT-LEDH33-BR01



YT-LEDH33-MS



YT-LEDH33-PCC



YT-LEDH33-PCD

T8 LED WEATHERPROOF LINEAR LIGHTS IP65



LED Tubes to be ordered separately see page 1-3

LED Standard Weatherproof Linear Light IP65 c/w Fuse Links | Easy Replacement

| Wired for L+N one end, Link Opposite end. **LED Tubes Excluded**

Clear Diffuser	Opal Diffuser	LED Tube Code	Lamp Power	Size (mm)
----------------	---------------	---------------	------------	-----------

Single Tube

LED-YZ-T8-8W-NT	YZ-8118-OP-EMPTY	LEDT8-A2FR-CW or DL	1x 8W (2FT)	675 x 85 x 90
LED-YZ-T8-18W-NT	YZ-8136-OP-EMPTY	LEDT8-A4FR-CW or DL	1x 18W (4FT)	1278 x 85 x 90
LED-YZ-T8-22W-NT	YZ-8158-OP-EMPTY	LEDT8-A5FR-CW or DL	1x 22W (5FT)	1578 x 85 x 90

Double Tube

LED-YZ-T8-2X8W-NT	YZ-8218-OP-EMPTY	LEDT8-A2FR-CW or DL	2x 8W (2FT)	675 x 110 x 80
LED-YZ-T8-2X18W-NT	YZ-8236-OP-EMPTY	LEDT8-A4FR-CW or DL	2x 18W (4FT)	1278 x 110 x 80
LED-YZ-T8-2X22W-NT	YZ-8258-OP-EMPTY	LEDT8-A5FR-CW or DL	2x 22W (5FT)	1578 x 110 x 80

For LED tubes see page 1-3 | **For Emergency Add Emergency Tube Code on page 3**

Accessories

Code	Wattage
LED-YZ-CLIP/S	Stainless Steel holding clips for YZ Diffuser

Wiring Diagram



T-BAY FLUORESCENT FITTINGS



T5 Louvred High Bay Fittings

- With Electronic Ballast
- Steel Grey Powder Coated
- For food industry applications use in combination with tube sleeves

Code 2 Lamp	Code 4 Lamp	Size (mm) L x W x H	Wattage per Lamp	Lamp Type G5
TB-235	-	1493 x 291 x 48	35W (5FT)	FLT5-35W
TB-254	-	1193 x 291 x 48	54W (4FT)	FLT5-54W
TB-280	-	1493 x 291 x 48	80W (5FT)	FLT5-80W
-	TB-454	1193 x 518 x 48	54W (4FT)	FLT5-54W
-	TB-480	1493 x 518 x 48	80W (5FT)	FLT5-80W

Lamps excluded. For lamps see page 19

Accessories

Code	Description
5L2-35E	Electronic Ballast for 2 x 35W
5IC2-54E	Electronic Ballast for 2 x 54W
SI-280	Electronic Ballast for 2 x 80W
TB-1493-RAIL	2 x Diffuser Rail 1493 x 31 x 7mm
TB-1493-DIFF4	Transparent Acrylic Diffuser 1493 x 498 x 3mm

Compact T5 Louvred High Bay Fittings

- With Electronic Ballast
- White Powder Coated
- For food industry applications use in combination with tube sleeves



Code 4 Lamp	Code 6 Lamp	Size (mm) L x W x H	Wattage per Lamp	Lamp Type G5
HB-L428A	-	1170 x 332 x 76	28W (4FT)	FLT5-28W
HB-L435A	-	1470 x 332 x 76	35W (5FT)	FLT5-35W
HB-L454A	-	1170 x 332 x 76	54W (4FT)	FLT5-54W
HB-L480A	-	1470 x 332 x 76	80W (5FT)	FLT5-80W
-	HB-L628A	1170 x 502 x 76	28W (4FT)	FLT5-28W
-	HB-L654A	1170 x 502 x 76	54W (4FT)	FLT5-54W
-	HB-L635A	1470 x 502 x 76	35W (5FT)	FLT5-35W
-	HB-L680A	1470 x 502 x 76	80W (5FT)	FLT5-80W

Lamps excluded. For lamps see page 19.

Accessories

Code	Description
5L2-28E	Electronic Ballast for 2 x 28W
5L2-35E	Electronic Ballast for 2 x 35W
5IC2-54E	Electronic Ballast for 2 x 54W
SI-280	Electronic Ballast for 2 x 80W



LED FLOOD/BAY LIGHTS IP65

Supply Voltage:
90-246VAC
• Meanwell Drivers
• Bridge Lux LEDs
• Colour Temp:
3000K



Code	LGCD60WD-WW	HLB00202-*	LGCD210WE-WW
Power	60 x 1W (70W)	58 x 1.73W (100W)	210W
Luminous Flux	7200lm	2622lm	23100lm
Equivalent Brightness	150W	600W	700W
Size (mm)	346 x 320 x 174	298D x Ø378	700 x 395 x 190

*Add colour to code: ○ CW (Cool White 5000k-5500k), ○ WW (Warm White 2700-3000k)

T8 FLUORESCENT ALUMINIUM FITTINGS IP65



F7118F



Material: Aluminium base and tempered glass cover.

For T8 type lamps. Stainless Steel Clips

Iron Ballast	Elec. Ballast	Emerg. Ballast	Lamp Power	Size L x W x H
F7118F	F7118F-ELC	-	1 x 18W (2FT)	675 x 120 x 95mm
F7218F	-	F7218F-EMG	2 x 18W (2FT)	675 x 150 x 95mm
F7136F	F7136F-ELC	-	1 x 36W (4FT)	1285 x 120 x 95mm
F7236F	F7236F-ELC	F7236F-EMG	2 x 36W (4FT)	1285 x 150 x 95mm
F7158F	F7158F-ELC	-	1 x 58W (5FT)	1585 x 120 x 95mm
-	F7258F-ELC	F7258F-EMG	2 x 58W (5FT)	1585 x 150 x 95mm

For Lamps see page 19

For Spare Glass add **-DIF** to Code. For example: **F7258F-DIF**

Accessories

Code	Description
NF7-CLIP/S	Spare Stainless Steel Clips

T5 RECESSED FLUORESCENT FITTINGS

SK-T5L328
SK-T5L354



SK-T5L228



SK-T5L314



T5-T1142R

T5 Recessed Double Parabolic Light Fittings With Electronic Ballasts | Lamps excluded

Size (mm) L x W x H	Code 2 Lamp	Code 3 Lamp		Code 4 Lamp	Wattage per Lamp	Lamp Type G5
		Normal	90min Emergency			
600 x 600 x 60	-	-	-	SK-T5L414	14W	FLT5-14
1200 x 295 x 60	T5-T1142R	-	-	-	28W	FLT5-28
1200 x 600 x 60	SK-T5L228	SK-T5L328	SK-T5L328-EMG	-	28W	FLT5-28
1200 x 600 x 60	-	SK-T5L354	-	-	54W	FLT5-54

Accessories

Code	Description
SK-T5L228-DIF	Spare Aluminium Louvre for SK-T5L228
SK-T5L314-DIF	Spare Aluminium Louvre for SK-T5L314
SK-T5L328-DIF	Spare Aluminium Louvre for SK-T5L328
SF-300	2 Meter 0.75 x 3 Core Cable with Samp Plug
SF-305	3 Meter 0.75 x 3 Core Cable with Samp Plug
SF-304	Assembly of 2 Meter Cable to Light Fitting

Recessed Fitting - White | With Electronic Ballast 230VAC | Double reflector system provides soft and glare-free lighting | Energy saving | Elegant and modern design | Lamps excluded. For Lamps see page 19

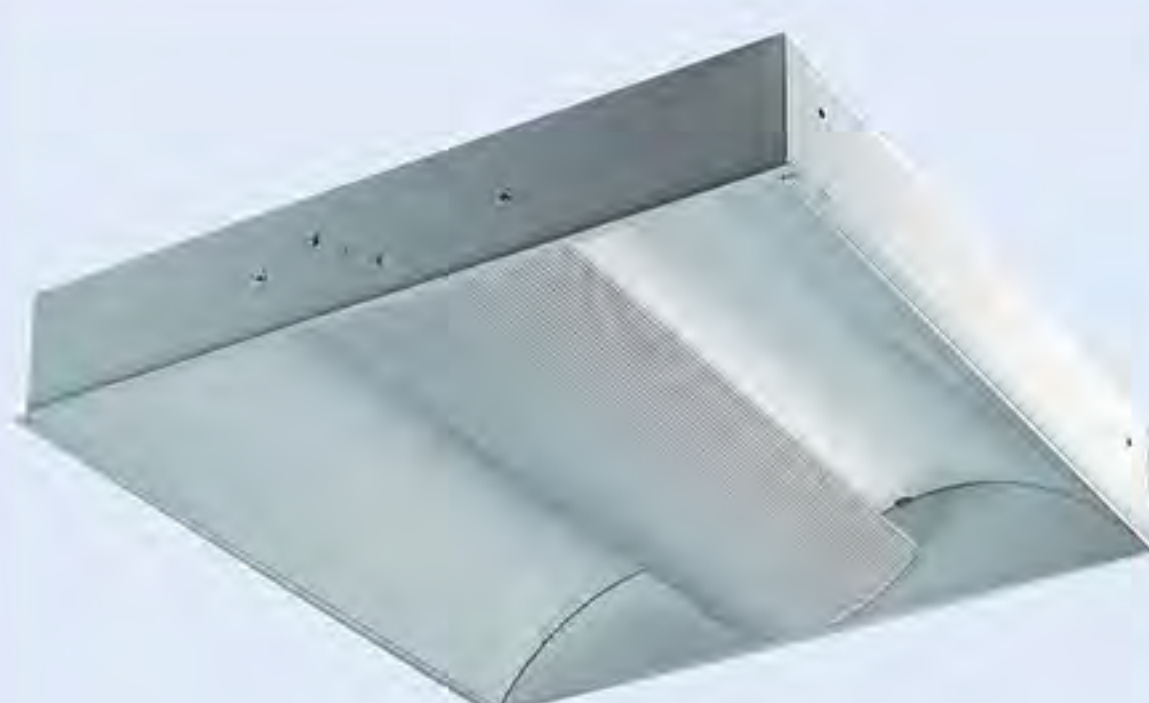

Code	No. of Lamps/Power	Size (mm) L x W x H
TCH-214	2 x 14W	595 x 595 x 90
TCH-220	2 x 28W	1195 x 595 x 90

Leading manufacturer, importer, and distributor of high-quality electrical and solar products tailored for both industrial and residential sectors. With an extensive network of distributors and franchises spanning across South Africa, we ensure superior service and widespread availability of our products, that meets the highest standards of performance and innovation.

LONGMEADOW

26 Nguni Drive
Longmeadow Business
Estate West, Edenvale
Gauteng

010 202 3300

info@acdc.co.za

GERMISTON

Sharland Street
Driehoek
Germiston
Gauteng

011 418 9600

germiston@acdc.co.za

RIVERHORSE

6 Riverhorse Close
Riverhorse
Valley Business Estate
Durban

031 492 4800

rvh@acdc.co.za

PINETOWN

Unit 10
Pine Industrial Estate
Pineside Road
New Germany

031 700 4215

kzn@acdc.co.za

CAPE TOWN

3(b) Richmond Southern
Close, Lenie Adams Ave
Richmond Park

021 492 2000

cape@acdc.co.za

National Sales Centre: **010 202 3400** | Technical: **010 202 3500** | Solar Hotline: **010 045 8002**



www.acdc.co.za



Note that specifications may undergo updates without prior notification in this publication. © ACDC Dynamics



THINK ELECTRICAL