

RHOMBERG

ACDC™

DYNAMICS

www.acdc.co.za

Follow the leaders in precision engineering

INDUSTRIAL INSTRUMENTS

designed to meet market requirements



THINK ELECTRICAL



CONTENTS

POWER MONITORS		DIN RAIL MOUNT VOLTAGE MONITORS	
SP100/SP103: Current Monitor, Single Phase	1	ZHRV2-36G: Single Phase Over/Under Voltage Protector	15
SP101/SP104: Current Monitor, Single Phase	1	ZHRV2-54T: Single Phase Over/Under Voltage Protector	15
SP120/SP123: Current Window Comparator, Single Phase	1	ZHRV2-S: 3Phase Over/Under Voltage/Phase Sequence/Failure/Asymmetry Monitor	15
SP121: DC Current Window Comparator	1	ZHRV3-01: Adjustable Phase Sequence/Failure/Asymmetry Monitor	15
SP200/SP201: Voltage Monitor, Single Phase	2	ZHRV3-07: 3Phase Voltage Monitor	15
SP220/SP221: Voltage Window Comparator, Single Phase	2	ZHRV5-01: Single Phase Voltage Window Comparator	16
AP221: Voltage Window Comparator, Single Phase AC/DC	2	ZHRV5-02: Single Phase Over/Under Voltage Monitor	16
AP224: Combined Over-Voltage & Under-Voltage Monitor-2 Independent Relays	2	ZHRV5-09: 3Phase Over/Under Voltage/Phase Sequence/Failure/Asymmetry Monitor	16
SP230/SP231/SP232: Voltage Window Comparator, Three Phase	3	ZHRV5-11: Phase Sequence/Failure/Asymmetry Monitor	16
AP231/AP232: Voltage Window Comparator, Three Phase	3		
AP234/AP235: Combined Over-Voltage and Under-Voltage Monitor, 3 Phase	3	MOTOR PROTECTION RELAYS	
SP320: Frequency Monitor	3	ZHRA2: Motor Protection Relay	17
SP430/SP431: Phase Sequence, Phase Failure, Phase Asymmetry Detector	4	ZHRA3: Motor Protection with remote	17
AP430/AP432: Phase Sequence, Phase Failure, Phase Asymmetry Monitor	4	ZHRA1: Current Monitor Motor Protector	18
SP510: Single Phase Reverse Power Monitor	4	ZHRA5: Self Powered Current Monitor Motor Protector	18
SX125/SX131: Phase Sequence, Phase Failure, Phase Asymmetry Detect with Alarm	4		
		LIQUID LEVEL CONTROLLER	
ELECTRONIC TIMERS		ZHRL1: DIN Rail Mount Liquid Level Controller	18
ST100/ST101: Multi-Function Timer	5		
AT100: Multi-Function Timer	5	SPECIAL PRODUCTS	
ST105/ST107: Delay on Timer	5	CM193: 3Phase Current Monitor	19
ST106/ST108: Interval (One Shot) Timer	5	DT310/12: Re-Cycling Timer with Pause	19
ST110/ST111/ST112/ST113: Electronic Reset Timer	5	PSM1130/3: Control Module for Inductive Sensors	19
AT110: Electronic Reset Timer	6	SAS110: Semi-Automatic Synchronising Unit	19
ST130: Star-Delta Timer	6	SP08M/SP08: Spark Detector Module and Optic	19
AT130: Star-Delta Timer	6		
ST200/201/202/203: Unequal Cycling Timer	6	DIGITAL PANEL METERS	
AT200: Asymmetrical Recycling Timer	6	Digital Panel Meters (48 x 48mm; 72 x 72mm; 48 x 96mm)	20
ST210: Multi-Function Asymmetrical Reset Timer	7	Digital Process Meters	21
ST300/ST301: No Power Delay Off Timer	7	Digital Timers and Counters	21
ST410/ST411: AC Interval or Complementary Lamp Flasher	7	Digital Time Switches	21
ST500: Multi-Start Attempt Unit	7		
AT500: Multi-Start Attempt Unit	7	INDUSTRIAL RELAYS & BASES	
48T100: Multi-Function Timer	8	8 & 14 Pin Industrial Relays & Bases	22
48T101: Delay On/Interval (One Shot) Timer	8	8 & 11 Pin Industrial Relays & Bases	23
		8 & 11 Pin Plug in Timercubes	23
PROCESS CONTROLLERS & COUNTLINE			
SC100: Control Module for Resistive Sensor	9	PROXIMITY SENSORS	
SC130: Liquid Level Controller	9	Opto Electronic Sensors	24
AC130: Liquid Level Controller	9	Capacitive Sensors	25
SC230: Level Control Module for NAMUR Sensor	9	Namur Sensors - Inductive & Capacitive	26
DCU: Distance Control Unit	9	DC Sensor Tester	27
SC300: Control Module for NAMUR Sensor	10	AC Inductive Sensors	27
SC301: Intrinsically Safe Control Module for NAMUR Sensor	10	Intelligent Can Line Sensor	28
SC314: 3-Wire DC Sensor Interface Relay Module	10	DC Inductive Sensors	28
SC320: Tachometer Relay	10	50 x 50mm Photo-Electric Sensors	29, 31
SC410/SC411: Opto-Electronic Control unit	11	M18Ø Photo-Electric Sensors	30, 31
SC501: Temperature Control Module	11		
SC510/SC511: Thermistor Motor Protection Module	11	ACCESSORIES	
SC610/SC611: Flip-Flop Relay with/without Memory	11	Accessories for Proximity Sensors	32
SC900: Power Supply Module	12	Liquid Level Probe Kits	32
CC120: Totalising Counter	12	Siren Modules	32
SC700: Multi-Function Preselect Counter	12	PT1: Pressure Transmitter	32
CC701: Preselect Counter	12		
MOTOR PROTECTION RELAYS		PROCESS GAUGES	
MP820: Motor System Protection Relay Underload Reset Timer, Single Phase	13	Stainless Steel Case with Bezel	33
MP825: Motor System Protection Relay Variable Underload Monitor, Single Phase	13	Robust Liquid Filled	33
MP830: Motor System Protection Relay Underload Reset Timer, Three Phase	13	Economic Injection Moulded Case	33
MP835: Motor System Protection Relay Variable Underload Monitor, Three Phase	13	Process Gauge Accessories	33
DIN RAIL MOUNT TIMERS		HOUSING DIMENSIONS & TECHNICAL SPECIFICATIONS	
ZHRT1-A: Delay On Timer	14	Slimline/A-Line/48 x 48 Timers Dimensions	34
ZHRT1-M: Multi-Function Timer	14	Counterline/Industrial Relays Dimensions	34
ZHRT1-ST: Star Delta Timer	14	Specifications for Relays fitted into: Slimline, A-Line AND Counterline	35
ZHRT1-LS: Passage Light Timer	14		
ZHRT1-S2: Unequal Cycling Timer	14		
ZHRT1-D: No power delay off	14		
ZHRT1-SD: Delay on restart timer	14		
ZHRT1-S3T: Unequal Cycling Timer	14		
ZHRT1-R3: Intermediate Relay	14		



POWER MONITORS

Type	Current Monitor - Single Phase	Current Monitor - Single Phase	Current Window Comparator - Single Phase	DC Current Window Comparator																																																															
Code	SP100/SP103	SP101/SP104	SP120/SP123	SP121																																																															
Features	<ul style="list-style-type: none"> Internal shunt for direct in-line current sensing (AC or DC) Adjustable responsible delay of 0.1 to 10 seconds on SP103 1A or 5A, AC or DC input range (programmable) Direct interface with conventional current transformers. Trip point adjustable on percentage scale Hysteresis adjustable 5-30% Programmable for overload or underload detection. Latching on overload or underload (programmable) Start-up delay 10A SPDT relay output 	<ul style="list-style-type: none"> Internal shunt for direct in-line sensing of currents up to 200mA (AC or DC) Adjustable responsible delay of 0.1 to 10 seconds on SP104 Direct interface with DC Shunt Resistors Trip point adjustable on calibrated scale 0-100% Hysteresis adjustable 5-30% Programmable for overload or underload detection. Latching on overload or underload (programmable). Start-up delay 10A SPDT relay output 	<ul style="list-style-type: none"> Direct in-line current sensing Combined overload and underload detection Internal shunt for direct in-line current sensing Adjustable responsible delay of 0.1 to 10 seconds on SP123 1A or 5A AC input range (programmable) Direct interface with conventional current transformers Separate adjustment of overload and underload threshold Latching in both modes. LED indications for overload, underload and normal load. Start-up delay 10A SPDT relay output 	<ul style="list-style-type: none"> Combined overload and under load detection Internal shunt for direct in-line sensing of currents up to 200mA DC Direct interface Separate adjustment of overload and underload thresholds Latching in both modes Range selector switch for 1mA, 20mA, 200mA, 60mV, 150mV, and 5V LED indication for overload, underload and normal load Start-up delay 10A SPDT relay output 																																																															
Connection Diagram																																																																			
Specifications	<p>POWER SUPPLY AC: Supply voltage: 12, 24, 115, 230, 400, 415, 525V ±15% Isolation (current input to power supply): 2kV Power consumption: 3VA (approx), 6VA for 415, 525V (approx) DC: Supply voltage: 10-30V, 48, 60, 110V ± 15% Isolation: no galvanic isolation. Power consumption: 100mA (10-30V), 30mA for 48V and higher</p> <p>CURRENT INPUT Trip point: 0.1 to 1A or 0.5 to 5A AC/DC (adjustable) Repetitive accuracy: 1% Hysteresis: 5% to 30% (adjustable)</p> <table border="1"> <thead> <tr> <th>Range</th> <th>Input Impedance</th> <th>Max. Input (Continuous)</th> </tr> </thead> <tbody> <tr> <td>1mA</td> <td>60 Ohm</td> <td>60mA</td> </tr> <tr> <td>20mA</td> <td>3 Ohm</td> <td>350mA</td> </tr> <tr> <td>200mA</td> <td>0.7 Ohm</td> <td>800mA</td> </tr> <tr> <td>60mV</td> <td>10k</td> <td>50V</td> </tr> <tr> <td>150mV</td> <td>10k</td> <td>50V</td> </tr> <tr> <td>5mV</td> <td>10k</td> <td>50V</td> </tr> </tbody> </table> <p>RESPONSE Start-up delay: Approximately 10 seconds, standard. (0.1 to 15 seconds also possible on special order) Response delay: SP100 - 1 second, SP103 - adjustable from 0.1 to 10 seconds (other ranges on special order)</p>	Range	Input Impedance	Max. Input (Continuous)	1mA	60 Ohm	60mA	20mA	3 Ohm	350mA	200mA	0.7 Ohm	800mA	60mV	10k	50V	150mV	10k	50V	5mV	10k	50V	<p>POWER SUPPLY AC: Supply voltage: 12, 24, 115, 230, 400, 415, 525V ±15% Isolation (current input to power supply): 2kV Power consumption: 3VA (approx), 6VA for 415, 525V (approx) DC: Supply voltage: 10-30V, 48, 60, 110V ± 15% Isolation: no galvanic isolation. Power consumption: 100mA (10-30V), 30mA for 48V and higher</p> <p>CURRENT INPUT Trip point: 0.1 to 1A or 0.5 to 5A AC (adjustable) Repetitive accuracy: 1% Hysteresis: 5% to 30% (adjustable)</p> <table border="1"> <thead> <tr> <th>Range</th> <th>Input Impedance</th> <th>Max. Input (Continuous)</th> </tr> </thead> <tbody> <tr> <td>1mA</td> <td>60 Ohm</td> <td>60mA</td> </tr> <tr> <td>20mA</td> <td>3 Ohm</td> <td>350mA</td> </tr> <tr> <td>200mA</td> <td>0.7 Ohm</td> <td>800mA</td> </tr> <tr> <td>60mV</td> <td>10k</td> <td>50V</td> </tr> <tr> <td>150mV</td> <td>10k</td> <td>50V</td> </tr> <tr> <td>5mV</td> <td>10k</td> <td>50V</td> </tr> </tbody> </table> <p>RESPONSE Start-up delay: approximately 10 seconds, standard. (1 to 15 seconds also possible on special order) Response delay: SP101 - 1 second. SP104 - adjustable from 0.1 to 10 seconds (other ranges on special order)</p>	Range	Input Impedance	Max. Input (Continuous)	1mA	60 Ohm	60mA	20mA	3 Ohm	350mA	200mA	0.7 Ohm	800mA	60mV	10k	50V	150mV	10k	50V	5mV	10k	50V	<p>POWER SUPPLY AC: Supply voltage: 12, 24, 115, 230, 400, 415, 525V ±15% Isolation (current input to power supply): 2kV Power consumption: 3VA (approx), 6VA for 415, 525V (approx) DC: Supply voltage: 10-30V, 48, 60, 110V ± 15% Isolation: no galvanic isolation. Power consumption: 100mA (10-30V), 30mA for 48V and higher</p> <p>CURRENT INPUT Trip point: 0.1 to 1A or 0.5 to 5A AC (adjustable) Repetitive accuracy: 1% Hysteresis: 2% Fixed (relative to trip point setting) Maximum input current (continuous): 6A Peak short-term over-current (10 seconds): 20A Current input impedance: 50 milliohms</p> <p>RESPONSE Start-up delay: approximately 10 seconds, standard (1 to 15 seconds also possible on special order) Response delay: SP120 - 1 second. SP123 - adjustable from 1 to 10 seconds (other ranges on special order)</p>	<p>POWER SUPPLY AC: Supply voltage: 12, 24, 115, 230, 400, 415, 525V ±15% Isolation (current input to power supply): 2kV Power consumption: 3VA (approx), 6VA for 415, 525V (approx) DC: Supply voltage: 12, 24, 48, 60, 110V ± 15% Isolation: no galvanic isolation. Power consumption: 100mA (12, 24V), 30mA for 48V and higher</p> <p>CURRENT INPUT Repetitive accuracy: 1% Hysteresis: 2% Fixed (relative to sensitivity setting)</p> <table border="1"> <thead> <tr> <th>Range</th> <th>Input Impedance</th> <th>Max. Input (Continuous)</th> </tr> </thead> <tbody> <tr> <td>1mA</td> <td>60 Ohm</td> <td>60mA</td> </tr> <tr> <td>20mA</td> <td>3 Ohm</td> <td>350mA</td> </tr> <tr> <td>200mA</td> <td>0.7 Ohm</td> <td>800mA</td> </tr> <tr> <td>60mV</td> <td>10k</td> <td>50V</td> </tr> <tr> <td>150mV</td> <td>10k</td> <td>50V</td> </tr> <tr> <td>5mV</td> <td>10k</td> <td>50V</td> </tr> </tbody> </table> <p>RESPONSE Start-up delay: approximately 10 seconds, standard (1 to 15 seconds also possible on special order) Response delay: SP121 - 1 second</p>	Range	Input Impedance	Max. Input (Continuous)	1mA	60 Ohm	60mA	20mA	3 Ohm	350mA	200mA	0.7 Ohm	800mA	60mV	10k	50V	150mV	10k	50V	5mV	10k	50V
Range	Input Impedance	Max. Input (Continuous)																																																																	
1mA	60 Ohm	60mA																																																																	
20mA	3 Ohm	350mA																																																																	
200mA	0.7 Ohm	800mA																																																																	
60mV	10k	50V																																																																	
150mV	10k	50V																																																																	
5mV	10k	50V																																																																	
Range	Input Impedance	Max. Input (Continuous)																																																																	
1mA	60 Ohm	60mA																																																																	
20mA	3 Ohm	350mA																																																																	
200mA	0.7 Ohm	800mA																																																																	
60mV	10k	50V																																																																	
150mV	10k	50V																																																																	
5mV	10k	50V																																																																	
Range	Input Impedance	Max. Input (Continuous)																																																																	
1mA	60 Ohm	60mA																																																																	
20mA	3 Ohm	350mA																																																																	
200mA	0.7 Ohm	800mA																																																																	
60mV	10k	50V																																																																	
150mV	10k	50V																																																																	
5mV	10k	50V																																																																	
*Relay Contacts: SP = Single Pole DP = Double Pole																																																																			
Ordering Code Example	TYPE MODEL VOLTAGE POWER SUPPLY RELAY CONTACTS SP 100 / 230V AC - *	TYPE MODEL VOLTAGE POWER SUPPLY RELAY CONTACTS SP 101 / 230V AC - *	TYPE MODEL VOLTAGE POWER SUPPLY RELAY CONTACTS SP 120 / 230V AC - *	TYPE MODEL VOLTAGE POWER SUPPLY RELAY CONTACTS SP 121 / 230V AC - *																																																															

POWER MONITORS

FAILSAFE FEATURES

Type	Voltage Monitor - Single Phase	Voltage Window Comparator - Single Phase	Voltage Window Comparator - Single Phase AC/DC	Combined Over/Under Voltage Monitor, 2 Independent Relays																																								
Code	SP200/SP201	SP220/SP221	AP221	AP224																																								
Features	<ul style="list-style-type: none"> • Programmable input voltage range 0 to 600V AC(RMS) or DC • Adjustable response delay from 0.1 to 10 seconds on SP201 • Voltage threshold adjustable on calibrated scale, 0-100% Adjustable hysteresis 5-30% • Programmable for over-voltage or under-voltage detection • Latching on over-voltage or under-voltage • 10A SPDT relay output 	<ul style="list-style-type: none"> • Combined over-voltage and under-voltage detection • Adjustable response delay of 0.1 to 10 seconds on SP221 • Monitoring of own supply voltage • High precision and repetitive accuracy • Independent setting of over-voltage and under-voltage tripping points • LED indication for type of fault and status of the relay • Latching facility • 10A SPDT relay output 	<ul style="list-style-type: none"> • DIN rail format • Combined over-voltage and under-voltage monitoring • Monitoring of own supply voltage • Selectable power supply voltages • High precision and repetitive accuracy • Independent adjustment of over-voltage and under-voltage setpoints • Adjustable response times available on trip and/or recovery (0.1-10 secs) • Adjustable start-up delay (0-10 secs) • Latching on over-voltage or under-voltage fault conditions (programmable) • LED indication for Relay ON, over-voltage & undervoltage • 5A DPDT relay output 	<ul style="list-style-type: none"> • DIN rail format • Combined over and under detection voltage • Internal shunt for direct in-line sensing of currents up to 200mA DC • Direct interface • Separate relay for over-voltage and under-voltage • Separate adjustment of overload and underload thresholds • Latching in both modes • Range selector switch for 1mA, 20mA, 200mA, 60mV, 150mV, and 5V • LED indication for overload, underload and normal load • Start-up delay • 5A DPDT relay output 																																								
Connection Diagram																																												
Specifications	<p>POWER SUPPLY AC: Supply voltage: 12, 24, 115, 230, 400, 415, 525V ±15% Isolation (current input to power supply): 2kV Power consumption: 3VA (approx), 6VA for 415, 525V (approx) DC: Supply voltage: 10-30V, 48, 60, 110V ± 15% Isolation: no galvanic isolation Power consumption: 100mA (10-30V), 30mA for 48V and higher VOLTAGE INPUT Repetitive accuracy: 1% Hysteresis: 5% to 30% (adjustable)</p> <table border="1"> <thead> <tr> <th>Range</th> <th>Input Impedance</th> <th>Max. Input Voltage</th> </tr> </thead> <tbody> <tr> <td>0-15V</td> <td>500k Ohm</td> <td>700V</td> </tr> <tr> <td>0-30V</td> <td>500k Ohm</td> <td>700V</td> </tr> <tr> <td>0-60V</td> <td>500k Ohm</td> <td>700V</td> </tr> <tr> <td>0-150V</td> <td>500k Ohm</td> <td>700V</td> </tr> <tr> <td>0-300V</td> <td>500k Ohm</td> <td>700V</td> </tr> <tr> <td>0-600V</td> <td>500k Ohm</td> <td>700V</td> </tr> </tbody> </table> <p>RESPONSE Response delay: SP200 - 1 second SP201 - adjustable from 0.1 to 10 seconds (other ranges on special order) Latching disabled during power-up: approx. 10 seconds</p>	Range	Input Impedance	Max. Input Voltage	0-15V	500k Ohm	700V	0-30V	500k Ohm	700V	0-60V	500k Ohm	700V	0-150V	500k Ohm	700V	0-300V	500k Ohm	700V	0-600V	500k Ohm	700V	<p>POWER SUPPLY AC: Supply voltage: 12, 24, 115, 230, 400, 415, 525V ±20% Isolation (current input to power supply): 2kV Power consumption: 3VA (approx), 6VA for 415, 525V (approx) DC: Supply voltage: 12, 24, 48, 60, 110V ±20% Isolation: no galvanic isolation Power consumption: 100mA (12, 24V), 30mA for 48V and higher VOLTAGE SENSING Calibrated to respond to RMS of a sinusoidal waveform Repetitive accuracy: 1% Hysteresis: 2% fixed (relative to its supply voltage) Response delay: SP220 - 1 second SP221 - adjustable from 0.1 to 10 seconds (other ranges on special order) Latching disabled during power-up: approx. 10 seconds</p>	<p>POWER SUPPLY AC: 12, 24, 115, 230, 400, 525V AC Isolation: Galvanic (without latching) Power consumption: 2VA (approx) Housing width: 45mm Voltage tolerance: ±20% DC: Supply voltage: 12, 24, 48, 60, 110V DC Isolation: No galvanic isolation Power consumption: 30mA (approx) Housing width: 45mm Voltage tolerance: ±20% VOLTAGE SENSING Repetitive accuracy: 1% Hysteresis: 2% fixed Hysteresis relates to the supply voltage Setpoints: The unit is calibrated to trip on the RMS value of the supply voltage (assuming no AC waveform distortion) RESPONSE Response time on trip: 0.1 - 10 seconds (adjustable) Response time on recovery: 0.1 - 10 seconds (adjustable) Start-up delay: 0 - 10 seconds (adjustable) Latching inhibited during power up</p>	<p>POWER SUPPLY AC: Supply voltage: 12, 24, 115, 400, 525V AC Isolation: Galvanic (without latching) Power consumption: 2VA (approx) Housing width: 45mm Voltage tolerance: ±20% DC: Supply voltage: 12, 24, 48, 60, 110V DC Isolation: No galvanic isolation Power consumption: 30mA (approx) Housing width: 45mm Voltage tolerance: ±20% VOLTAGE SENSING Repetitive accuracy: 1% Hysteresis: 2% (fixed) Setpoints: The unit is calibrated to trip on the RMS value of the supply voltage (assuming no AC waveform distortion) RESPONSE Response time on trip: 0,1 - 10 seconds (adjustable) Response time on recovery: 0,1 - 10 seconds (adjustable) Start-up delay: 0 - 10 seconds (adjustable) Latching inhibited during power up</p>																			
Range	Input Impedance	Max. Input Voltage																																										
0-15V	500k Ohm	700V																																										
0-30V	500k Ohm	700V																																										
0-60V	500k Ohm	700V																																										
0-150V	500k Ohm	700V																																										
0-300V	500k Ohm	700V																																										
0-600V	500k Ohm	700V																																										
*Relay Contacts: SP = Single Pole DP = Double Pole																																												
Ordering Code Example	<table border="1"> <tr> <td>TYPE</td> <td>MODEL</td> <td>VOLTAGE</td> <td>POWER SUPPLY</td> <td>RELAY CONTACTS</td> </tr> <tr> <td>SP</td> <td>200</td> <td>230V</td> <td>AC</td> <td>*</td> </tr> </table>	TYPE	MODEL	VOLTAGE	POWER SUPPLY	RELAY CONTACTS	SP	200	230V	AC	*	<table border="1"> <tr> <td>TYPE</td> <td>MODEL</td> <td>VOLTAGE</td> <td>POWER SUPPLY</td> <td>RELAY CONTACTS</td> </tr> <tr> <td>SP</td> <td>220</td> <td>230V</td> <td>AC</td> <td>*</td> </tr> </table>	TYPE	MODEL	VOLTAGE	POWER SUPPLY	RELAY CONTACTS	SP	220	230V	AC	*	<table border="1"> <tr> <td>TYPE</td> <td>MODEL</td> <td>VOLTAGE</td> <td>POWER SUPPLY</td> <td>RELAY CONTACTS</td> </tr> <tr> <td>AP</td> <td>221</td> <td>230V</td> <td>AC</td> <td>DP</td> </tr> </table>	TYPE	MODEL	VOLTAGE	POWER SUPPLY	RELAY CONTACTS	AP	221	230V	AC	DP	<table border="1"> <tr> <td>TYPE</td> <td>MODEL</td> <td>VOLTAGE</td> <td>POWER SUPPLY</td> <td>RELAY CONTACTS</td> </tr> <tr> <td>AP</td> <td>224</td> <td>230V</td> <td>AC</td> <td>SP</td> </tr> </table>	TYPE	MODEL	VOLTAGE	POWER SUPPLY	RELAY CONTACTS	AP	224	230V	AC	SP
TYPE	MODEL	VOLTAGE	POWER SUPPLY	RELAY CONTACTS																																								
SP	200	230V	AC	*																																								
TYPE	MODEL	VOLTAGE	POWER SUPPLY	RELAY CONTACTS																																								
SP	220	230V	AC	*																																								
TYPE	MODEL	VOLTAGE	POWER SUPPLY	RELAY CONTACTS																																								
AP	221	230V	AC	DP																																								
TYPE	MODEL	VOLTAGE	POWER SUPPLY	RELAY CONTACTS																																								
AP	224	230V	AC	SP																																								



POWER MONITORS

Type	Voltage Window Comparator - Three Phase	Three Phase Voltage Window Comparator, Phase Sequence & Failure	Combined Over/Under-Voltage Monitor - Three Phase	Frequency Monitor																																								
Code	SP230/SP231/SP232	AP231/AP232	AP234/AP235	SP320																																								
Features	<ul style="list-style-type: none"> • Combined over-voltage and under-voltage detection • Monitoring of own supply voltage • Adjustable response delay on SP231 • SP232 available with neutral • High precision and repetitive accuracy • Independent setting of over-voltage tripping points • LED indication for type of fault and status of the relay • Latching facility • 10A SPDT relay output 	<ul style="list-style-type: none"> • Phase Failure • Phase Sequence • Combined over-voltage and under-voltage monitoring • Monitoring of own supply voltages • AP232 available with neutral • Selectable power supply voltages • High precision and repetitive accuracy • Independent adjustment of over-voltage and under-voltage setpoints • Separately adjustable response times on trip and recovery (0.1 to 10 secs) • Adjustable start-up delay (0-10 secs) • Latching of fault conditions (prog.) • Microprocessor technology incorporated • LED indication for type of fault and relay status • 5A DPDT relay as standard • DIN rail mounting 	<ul style="list-style-type: none"> • Phase Failure (AP234) • Phase & Neutral Failure (AP235) • DIN rail format • Combined over-voltage and under-voltage monitoring • Separate relays for over-voltage and under-voltage • Monitoring of own supply voltage • AP235 Available with neutral • Selectable power supply voltages • High precision and repetitive accuracy • Independent adjustment of over-voltage and under-voltage setpoints • Adjustable response times - available on trip and/or recovery (0.1 to 10 seconds) • LED indication of over-voltage relay on and under-voltage relay on (power LED flashes when timing) • 8A SPDT over-voltage relay output 	<ul style="list-style-type: none"> • Monitoring frequency of own power supply • High precision and repetitive accuracy • Independent setting of over and under-frequency tripping point • LED indication of type of fault and relay status • Programmable for over-frequency, under-frequency or frequency window detection • Start-up delay • 10A SPDT relay output 																																								
Connection Diagram																																												
Specifications	<p>POWER SUPPLY Supply voltage (phase-to-phase): 115, 230, 400, 415, 525V AC $\pm 15\%$ Power consumption: 3VA (approx), 6VA for 415, 525V AC (approx)</p> <p>VOLTAGE SENSING Calibrated to respond to the RMS of a sinusoidal waveform. Repetitive accuracy: 1% Hysteresis: 2% fixed (relative to its supply voltage) Response delay: 1 second Latching disabled during power-up: approx. 10 seconds - SP231 Only</p>	<p>POWER SUPPLY Supply type: AC transformer supply only Supply voltage: 115, 230, 400, 525V Housing width: 45mm Power consumption: 2VA (approx) Isolation: Galvanic Voltage tolerance: $\pm 20\%$</p> <p>VOLTAGE SENSING Setpoints: The unit is calibrated to trip on the RMS value of the supply voltage (assuming no AC waveform distortion) Repetitive accuracy: 1% Hysteresis: 2% (fixed) Hysteresis relates to the supply voltage</p> <p>RESPONSE Response time on trip: 0.1 - 10 seconds (adjustable) Response time on recovery: 0.1 - 10 seconds (adjustable) Start-up delay: 0 - 10 seconds Latching inhibited during power up</p>	<p>POWER SUPPLY Supply type: AC transformer supply only Supply voltage: 115, 230, 400, 525V AC Housing width: 45mm Power consumption: 2VA (approx) (without latching) Voltage tolerance: $\pm 20\%$</p> <p>VOLTAGE SENSING Setpoints: The unit is calibrated to trip on the RMS value of the supply voltage (assuming no AC waveform distortion) Repetitive accuracy: 1% Hysteresis: 2% (fixed) Hysteresis relates to the supply voltage</p> <p>RESPONSE Response time on trip: 0.1 - 10 seconds (adjustable) Response time on recovery: 0.1 - 10 seconds (adjustable) Start-up delay: 0 - 10 seconds (adjustable) Latching inhibited during power up</p>	<p>POWER SUPPLY Supply voltage: 12, 24, 115, 230, 400, 415, 525V, AC $\pm 15\%$ Power consumption: 3VA (approx), 6VA for 415, 525V (approx) Supply frequency: 42Hz - 58Hz (60Hz available on special order)</p> <p>RESPONSE Start-up delay: Approximately 10 seconds standard (1 to 15 seconds available on special order) Response delay: 1 second</p> <p>FREQUENCY SENSING Repetitive accuracy: 1% Hysteresis: 0.5 Hz fixed</p>																																								
*Relay Contacts: SP = Single Pole DP = Double Pole																																												
Ordering Code Example	<table border="1"> <tr> <th>TYPE</th> <th>MODEL</th> <th>VOLTAGE</th> <th>POWER SUPPLY</th> <th>RELAY CONTACTS</th> </tr> <tr> <td>SP</td> <td>230</td> <td>230V</td> <td>AC</td> <td>*</td> </tr> </table>	TYPE	MODEL	VOLTAGE	POWER SUPPLY	RELAY CONTACTS	SP	230	230V	AC	*	<table border="1"> <tr> <th>TYPE</th> <th>MODEL</th> <th>VOLTAGE</th> <th>POWER SUPPLY</th> <th>RELAY CONTACTS</th> </tr> <tr> <td>AP</td> <td>231</td> <td>230V</td> <td>AC</td> <td>DP</td> </tr> </table>	TYPE	MODEL	VOLTAGE	POWER SUPPLY	RELAY CONTACTS	AP	231	230V	AC	DP	<table border="1"> <tr> <th>TYPE</th> <th>MODEL</th> <th>VOLTAGE</th> <th>POWER SUPPLY</th> <th>RELAY CONTACTS</th> </tr> <tr> <td>AP</td> <td>234</td> <td>230V</td> <td>AC</td> <td>SP</td> </tr> </table>	TYPE	MODEL	VOLTAGE	POWER SUPPLY	RELAY CONTACTS	AP	234	230V	AC	SP	<table border="1"> <tr> <th>TYPE</th> <th>MODEL</th> <th>VOLTAGE</th> <th>POWER SUPPLY</th> <th>RELAY CONTACTS</th> </tr> <tr> <td>SP</td> <td>320</td> <td>230V</td> <td>AC</td> <td>*</td> </tr> </table>	TYPE	MODEL	VOLTAGE	POWER SUPPLY	RELAY CONTACTS	SP	320	230V	AC	*
TYPE	MODEL	VOLTAGE	POWER SUPPLY	RELAY CONTACTS																																								
SP	230	230V	AC	*																																								
TYPE	MODEL	VOLTAGE	POWER SUPPLY	RELAY CONTACTS																																								
AP	231	230V	AC	DP																																								
TYPE	MODEL	VOLTAGE	POWER SUPPLY	RELAY CONTACTS																																								
AP	234	230V	AC	SP																																								
TYPE	MODEL	VOLTAGE	POWER SUPPLY	RELAY CONTACTS																																								
SP	320	230V	AC	*																																								

POWER MONITORS

FAILSAFE FEATURES

Type	Phase Sequence, Phase Failure, Phase Asymmetry Detector	Phase Sequence, Phase Failure, Phase Asymmetry Monitor	Single Phase, Reverse Power Monitor (Generator Protection)	Phase Sequence, Phase Failure, Phase Asymmetry Detector with Alarm																																								
Code	SP430/SP431	AP430/AP432	SP510	SX125/SX131																																								
Features	<ul style="list-style-type: none"> Detection of phase asymmetry Adjustable sensitivity Insensitive to regenerated EMF High stability under harmonic distortion Insensitive to balanced supply voltage variations Fast response to reversed phase sequence SP431 available with neutral 10A SPDT Relay output 	<ul style="list-style-type: none"> DIN rail mount Detection of phase asymmetry Adjustable Negative Phase Sequence (NPS) sensitivity Insensitive to regenerated EMF High stability under harmonic distortion Insensitive to balance supply voltage variations Fast response to reversed phase sequence AP432 Available with neutral Power ON and Relay ON LED's 	<ul style="list-style-type: none"> Reverse current tripping level adjustable up to 20% of maximum forward current Current monitoring through internal shunt Response time adjustable up to 10 seconds Start-up delay adjustable up to 10 seconds Insensitive to changes in power factor LED indication for reverse power and Relay ON Latching facility 10A SPDT Relay output 	<ul style="list-style-type: none"> Detection of phase asymmetry Clear warning alarm when detection occurs (SX131) 5mm bright LED indication when detection occurs (SX125) Insensitive to regenerated EMF High stability under harmonic distortion Insensitive to balanced supply voltage variations Fast response to reversed phase sequence 10A DPDT Relay Output 																																								
Connection Diagram	<p>DPDT on request</p>	<p>SPDT On Request</p>	<p>DPDT On Request (No Latching)</p>	<p>DPDT Only</p>																																								
Specifications	<p>POWER SUPPLY Supply voltage (phase-to-phase): 115, 230, 400, 440, 525V AC $\pm 15\%$ Power consumption: 3VA (approx), 6VA for 415, 525V AC (approx)</p> <p>VOLTAGE SENSING Repetitive accuracy: 1% Hysteresis: 2% fixed (relative to its supply voltage) Response delay: 1 second (approx)</p>	<p>POWER SUPPLY Type: AC transformer (2kV galvanic isolation) Voltage: 115, 230, 400, 525, 550V Tolerance: $\pm 20\%$ Power consumption: 2VA (approx)</p> <p>HOUSING 250V and below: 22.5mm width Above 250V: 45mm width</p> <p>VOLTAGE SENSING Repetitive accuracy: 1% Hysteresis: 2% (fixed) Hysteresis relates to the supply voltage Response delay: 1 second (approx)</p> <p>RELAY Relay options (250V): 10A SPDT or 5A DPDT</p>	<p>POWER SUPPLY Supply voltage: 115, 230, 400, 415, 525V AC $\pm 15\%$ Power consumption: 3VA (approx), 6VA for 415, 525V AC (approx)</p> <p>CURRENT INPUT Input current range: 0 - 5A AC Reverse current sensitivity: 100mA to 1A AC (adjustable) Repetitive accuracy: 1% Hysteresis: 5% (fixed) Maximum input current (continuous): 6A Peak short term over current (10 seconds): 20A Current input impedance: 50 milliohms</p> <p>RESPONSE Start-up delay: 0 - 10 seconds (adjustable) Response delay: 1 - 10 seconds (adjustable)</p>	<p>POWER SUPPLY Supply voltage (phase-to-phase): 115, 230, 400, 525V AC $\pm 20\%$ Power consumption: 3VA (approx), 6VA for 415, 525V AC (approx)</p> <p>VOLTAGE SENSING Repetitive accuracy: 1% Hysteresis: 2% fixed (relative to its supply voltage) Response delay: 1 second (approx)</p>																																								
*Relay contact SP= Single Pole DP= Double Pole																																												
Ordering Code Example	<table border="1"> <tr> <td>TYPE</td> <td>MODEL</td> <td>VOLTAGE</td> <td>POWER SUPPLY</td> <td>RELAY CONTACTS</td> </tr> <tr> <td>SP</td> <td>430</td> <td>230V</td> <td>AC</td> <td>*</td> </tr> </table>	TYPE	MODEL	VOLTAGE	POWER SUPPLY	RELAY CONTACTS	SP	430	230V	AC	*	<table border="1"> <tr> <td>TYPE</td> <td>MODEL</td> <td>VOLTAGE</td> <td>POWER SUPPLY</td> <td>RELAY CONTACTS</td> </tr> <tr> <td>AP</td> <td>430</td> <td>230V</td> <td>AC</td> <td>*</td> </tr> </table>	TYPE	MODEL	VOLTAGE	POWER SUPPLY	RELAY CONTACTS	AP	430	230V	AC	*	<table border="1"> <tr> <td>TYPE</td> <td>MODEL</td> <td>VOLTAGE</td> <td>POWER SUPPLY</td> <td>RELAY CONTACTS</td> </tr> <tr> <td>SP</td> <td>510</td> <td>230V</td> <td>AC</td> <td>*</td> </tr> </table>	TYPE	MODEL	VOLTAGE	POWER SUPPLY	RELAY CONTACTS	SP	510	230V	AC	*	<table border="1"> <tr> <td>TYPE</td> <td>MODEL</td> <td>VOLTAGE</td> <td>POWER SUPPLY</td> <td>RELAY CONTACTS</td> </tr> <tr> <td>SX</td> <td>125</td> <td>230V</td> <td>AC</td> <td></td> </tr> </table>	TYPE	MODEL	VOLTAGE	POWER SUPPLY	RELAY CONTACTS	SX	125	230V	AC	
TYPE	MODEL	VOLTAGE	POWER SUPPLY	RELAY CONTACTS																																								
SP	430	230V	AC	*																																								
TYPE	MODEL	VOLTAGE	POWER SUPPLY	RELAY CONTACTS																																								
AP	430	230V	AC	*																																								
TYPE	MODEL	VOLTAGE	POWER SUPPLY	RELAY CONTACTS																																								
SP	510	230V	AC	*																																								
TYPE	MODEL	VOLTAGE	POWER SUPPLY	RELAY CONTACTS																																								
SX	125	230V	AC																																									



ELECTRONIC TIMERS





Type	Multi-Function Timer	Multi-Function Timer	Delay on Timer	Interval (One Shot)	Electronic Reset Timer																																																																																																																												
Code	ST100/ST101	AT100	ST105/ST107	ST106/ST108	ST110/ST111/ST112/ST113																																																																																																																												
Features	<ul style="list-style-type: none"> Programmable functions: Delayed ON, Interval (one shot), Equal Repeating Programmable functions and independent overlapping time ranges Extended supply voltage range: 10V to 30V AC/DC, 90V to 250V AC Specific power supply voltage available on request Time adjustment on calibrated scale: 0 - 100% High repetitive accuracy 5A DPDT relay output Time range: ST100: Up to 120 sec. ST101: Up to 240 min Extended time ranges available up to 25 hours or 200 hours on special order 	<ul style="list-style-type: none"> 4 programmable functions: Delayed ON, Interval (one shot) or Equal Repeating (OFF/ON first) 18 overlapping programmable time ranges from 0.2sec - 100 hours, achieved by: <ul style="list-style-type: none"> 3 programmable time ranges: seconds, minutes, hours 6 programmable time scales for each of 3 time ranges Time Settings on calibrated scale (10% - 100%) High repetitive accuracy Microprocessor technology Power ON and Relay ON LED's Flashing Power ON LED when unit is timing 5A SPDT or DPDT relay output 	<ul style="list-style-type: none"> Delay ON Adjustable single time range Extended supply voltage range: 10V to 30VDC, 48VDC, 110VDC 24VAC, 48VAC, 115VAC, 230VAC 90V to 250VAC, 400VAC Time adjusted on calibrated scale 0 - 100% High repetitive accuracy Relay: 5A SPDT or 5A DPDT Time Ranges: <table border="1"> <tr> <td>ST105</td> <td>ST107</td> </tr> <tr> <td>120 Seconds</td> <td>240 Minutes</td> </tr> </table> 	ST105	ST107	120 Seconds	240 Minutes	<ul style="list-style-type: none"> Interval (One Shot) Adjustable single time range Extended supply voltage range: 10V to 30VDC, 48VDC, 110VDC 24VAC, 48VAC, 115VAC, 230VAC 90V to 250VAC, 400VAC Time adjusted on calibrated scale 0 - 100% High repetitive accuracy Relay: 5A SPDT or 5A DPDT Time Ranges: <table border="1"> <tr> <td>ST106</td> <td>ST108</td> </tr> <tr> <td>120 Seconds</td> <td>240 Minutes</td> </tr> </table> 	ST106	ST108	120 Seconds	240 Minutes	<ul style="list-style-type: none"> Programmable functions: Delayed ON, Interval (one shot), both with hold or pulse reset Programmable in six independent overlapping time ranges Direct interface with DC three-wire NPN (ST110/ST111) and PNP (ST112/ST113) sensors High speed electronic reset & repetitive accuracy Time adjustment on calibrated scale, 0-100% 5A double pole relay output (10A SPDT offered on request) Time Ranges: <ul style="list-style-type: none"> ST110/ST112: Up to 120 sec ST111/ST113: Up to 240 min Extended time ranges available up to 200 hours on special orders 																																																																																																																				
ST105	ST107																																																																																																																																
120 Seconds	240 Minutes																																																																																																																																
ST106	ST108																																																																																																																																
120 Seconds	240 Minutes																																																																																																																																
Connection Diagram																																																																																																																																	
Specifications	<p>POWER SUPPLY AC: Supply voltage: Not galvanic: 230VAC = 90 - 250VAC Galvanic: 12, 115, 230, 400, 415, 525V ±15% Power consumption: 3VA (approx), 6VA for 415, 525V (approx) DC: Supply voltage: 48, 60, 110V ±15% Power consumption: 30mA AC/DC: Supply voltage: 10 - 30V Power consumption: 100mA Reset: Power supply to be interrupted for at least 0.5 seconds. For high speed reset applications, refer to ST110</p> <table border="1"> <tr> <th colspan="2">ST-100</th> </tr> <tr> <th>Switch S1</th> <th>Time Ranges</th> </tr> <tr> <td>1.8s</td> <td>- Up to 1.8s</td> </tr> <tr> <td>7.5s</td> <td>- Up to 7.5s</td> </tr> <tr> <td>15s</td> <td>- Up to 15s</td> </tr> <tr> <td>30s</td> <td>- Up to 30s</td> </tr> <tr> <td>60s</td> <td>- Up to 60s</td> </tr> <tr> <td>120s</td> <td>- Up to 120s</td> </tr> </table> <p>ST-101</p> <table border="1"> <tr> <th>Switch S1</th> <th>Time Ranges</th> </tr> <tr> <td>220s</td> <td>- Up to 220s</td> </tr> <tr> <td>7.5m</td> <td>- Up to 7.5m</td> </tr> <tr> <td>15m</td> <td>- Up to 15m</td> </tr> <tr> <td>60m</td> <td>- Up to 60m</td> </tr> <tr> <td>120m</td> <td>- Up to 120m</td> </tr> <tr> <td>240m</td> <td>- Up to 240m</td> </tr> </table> <p>Extended time range available on special order: 6, 12, 5, 25, 50, 100, and 200 hours</p>	ST-100		Switch S1	Time Ranges	1.8s	- Up to 1.8s	7.5s	- Up to 7.5s	15s	- Up to 15s	30s	- Up to 30s	60s	- Up to 60s	120s	- Up to 120s	Switch S1	Time Ranges	220s	- Up to 220s	7.5m	- Up to 7.5m	15m	- Up to 15m	60m	- Up to 60m	120m	- Up to 120m	240m	- Up to 240m	<p>POWER SUPPLY AC: Supply voltage: 12, 24, 115, 230, 400, 415, 525V Power Consumption: 2VA (approx) Tolerance: ±15% AC Reactive: Supply Voltage: 230VAC = 90-250VAC Power consumption: 2VA (approx) DC: Supply Voltage: 48, 60, 110V Power Consumption: 30mA (approx) Tolerance: ±15% AC/DC: Supply Voltage: 12/24V Power Consumption: 100mA (approx) Tolerance: 15%</p> <p>TIME SPECIFICATION Setting Accuracy: 5% Repeatability: 0.5%</p> <p>HOUSING 250V and below: 22.5mm width. Above 250V: 45mm width</p> <p>RELAY Relay Options (250V, 5A) SPDT, DPDT</p> <p>TIME RANGES (STANDARD) 2: 0.2 to 2 sec, min or hrs 5: 0.5 to 5 sec, min or hrs 10: 1 to 10 sec, min or hrs 20: 2 to 20 sec, min or hrs 50: 5 to 50 sec, min or hrs 100: 10 to 100 sec, min or hrs</p>	<p>POWER SUPPLY AC: Supply voltage: Not Galvanic 250VAC = 90 - 250VAC Galvanic: 12,24,48,115,230,400, 415 525V ±15% Power Consumption: 3VA (approx) 6VA FOR 415, 525V (approx) DC: Supply Voltage: 48,60,110,220V ±15% Power Consumption: 30mA (approx) AC/DC: Supply Voltage: 10 - 30V Power Consumption: 100mA (approx) Reset: Power supply to be interrupted for at least 0.5 seconds.</p> <table border="1"> <tr> <th colspan="2">ST105</th> <th colspan="2">ST107</th> </tr> <tr> <th>Sw Pos</th> <th>Time</th> <th>Sw Pos</th> <th>Time</th> </tr> <tr> <td>1</td> <td>Up to 1.8s</td> <td>1</td> <td>Up to 220s</td> </tr> <tr> <td>2</td> <td>Up to 7.5s</td> <td>2</td> <td>Up to 7.5m</td> </tr> <tr> <td>3</td> <td>Up to 15s</td> <td>3</td> <td>Up to 15m</td> </tr> <tr> <td>4</td> <td>Up to 30s</td> <td>4</td> <td>Up to 60m</td> </tr> <tr> <td>5</td> <td>Up to 60s</td> <td>5</td> <td>Up to 120m</td> </tr> <tr> <td>6</td> <td>Up to 120s</td> <td>6</td> <td>Up to 240m</td> </tr> </table> <p>**E = External Pot **I = Instantaneous Contacts **TX = Galvanic</p> <p>*Relay contact SP= Single Pole DP= Double Pole</p>	ST105		ST107		Sw Pos	Time	Sw Pos	Time	1	Up to 1.8s	1	Up to 220s	2	Up to 7.5s	2	Up to 7.5m	3	Up to 15s	3	Up to 15m	4	Up to 30s	4	Up to 60m	5	Up to 60s	5	Up to 120m	6	Up to 120s	6	Up to 240m	<p>POWER SUPPLY AC: Supply voltage: Not Galvanic 250VAC = 90 - 250VAC Galvanic: 12,24,48,115,230,400, 415 525V ±15% Power Consumption: 3VA (approx) 6VA FOR 400 (approx) DC: Supply Voltage: 48,60,110,220V ±15% Power Consumption: 30mA (approx) AC/DC: Supply Voltage: 10 - 30V Power Consumption: 100mA (approx) Reset: Power supply to be interrupted for at least 0.5 seconds.</p> <table border="1"> <tr> <th colspan="2">ST106</th> <th colspan="2">ST108</th> </tr> <tr> <th>Sw Pos</th> <th>Time</th> <th>Sw Pos</th> <th>Time</th> </tr> <tr> <td>1</td> <td>Up to 1.8s</td> <td>1</td> <td>Up to 220s</td> </tr> <tr> <td>2</td> <td>Up to 7.5s</td> <td>2</td> <td>Up to 7.5m</td> </tr> <tr> <td>3</td> <td>Up to 15s</td> <td>3</td> <td>Up to 15m</td> </tr> <tr> <td>4</td> <td>Up to 30s</td> <td>4</td> <td>Up to 60m</td> </tr> <tr> <td>5</td> <td>Up to 60s</td> <td>5</td> <td>Up to 120m</td> </tr> <tr> <td>6</td> <td>Up to 120s</td> <td>6</td> <td>Up to 240m</td> </tr> </table> <p>**E = External Pot **I = Instantaneous Contacts **TX = Galvanic</p> <p>*Relay contact SP= Single Pole DP= Double Pole</p>	ST106		ST108		Sw Pos	Time	Sw Pos	Time	1	Up to 1.8s	1	Up to 220s	2	Up to 7.5s	2	Up to 7.5m	3	Up to 15s	3	Up to 15m	4	Up to 30s	4	Up to 60m	5	Up to 60s	5	Up to 120m	6	Up to 120s	6	Up to 240m	<p>POWER SUPPLY AC: Supply voltage: 12, 24, 115, 230, 400, 415, 525V ±15%. Isolation (reset input to power supply): 2kV Power consumption: 3VA (approx), 6VA for 415, 525V (approx) DC: Supply voltage: 10-30V, 48, 60, 110V ± 15% Isolation: no galvanic isolation. Power consumption: 100mA (10-30V), 30mA for higher ranges RESET INPUT Reset time: 2 milliseconds Short circuit current: 1mA Open circuit voltage: 8.2V 12V DC OUTPUT: Voltage tolerance: 10-15V DC Source current: 30mA (max.)</p> <table border="1"> <tr> <th colspan="2">ST-110/112</th> </tr> <tr> <th>Switch S1</th> <th>Time Ranges</th> </tr> <tr> <td>1.8s</td> <td>- Up to 1.8s</td> </tr> <tr> <td>7.5s</td> <td>- Up to 7.5s</td> </tr> <tr> <td>15s</td> <td>- Up to 15s</td> </tr> <tr> <td>30s</td> <td>- Up to 30s</td> </tr> <tr> <td>60s</td> <td>- Up to 60s</td> </tr> <tr> <td>120s</td> <td>- Up to 120s</td> </tr> </table> <p>ST-111/113</p> <table border="1"> <tr> <th>Switch S1</th> <th>Time Ranges</th> </tr> <tr> <td>220s</td> <td>- Up to 220s</td> </tr> <tr> <td>7.5m</td> <td>- Up to 7.5m</td> </tr> <tr> <td>15m</td> <td>- Up to 15m</td> </tr> <tr> <td>60m</td> <td>- Up to 60m</td> </tr> <tr> <td>120m</td> <td>- Up to 120m</td> </tr> <tr> <td>240m</td> <td>- Up to 240m</td> </tr> </table> <p>Extended time ranges on special order: • 6, 12, 5 and 25 hours • 50, 100, and 200 hours</p>	ST-110/112		Switch S1	Time Ranges	1.8s	- Up to 1.8s	7.5s	- Up to 7.5s	15s	- Up to 15s	30s	- Up to 30s	60s	- Up to 60s	120s	- Up to 120s	Switch S1	Time Ranges	220s	- Up to 220s	7.5m	- Up to 7.5m	15m	- Up to 15m	60m	- Up to 60m	120m	- Up to 120m	240m	- Up to 240m
ST-100																																																																																																																																	
Switch S1	Time Ranges																																																																																																																																
1.8s	- Up to 1.8s																																																																																																																																
7.5s	- Up to 7.5s																																																																																																																																
15s	- Up to 15s																																																																																																																																
30s	- Up to 30s																																																																																																																																
60s	- Up to 60s																																																																																																																																
120s	- Up to 120s																																																																																																																																
Switch S1	Time Ranges																																																																																																																																
220s	- Up to 220s																																																																																																																																
7.5m	- Up to 7.5m																																																																																																																																
15m	- Up to 15m																																																																																																																																
60m	- Up to 60m																																																																																																																																
120m	- Up to 120m																																																																																																																																
240m	- Up to 240m																																																																																																																																
ST105		ST107																																																																																																																															
Sw Pos	Time	Sw Pos	Time																																																																																																																														
1	Up to 1.8s	1	Up to 220s																																																																																																																														
2	Up to 7.5s	2	Up to 7.5m																																																																																																																														
3	Up to 15s	3	Up to 15m																																																																																																																														
4	Up to 30s	4	Up to 60m																																																																																																																														
5	Up to 60s	5	Up to 120m																																																																																																																														
6	Up to 120s	6	Up to 240m																																																																																																																														
ST106		ST108																																																																																																																															
Sw Pos	Time	Sw Pos	Time																																																																																																																														
1	Up to 1.8s	1	Up to 220s																																																																																																																														
2	Up to 7.5s	2	Up to 7.5m																																																																																																																														
3	Up to 15s	3	Up to 15m																																																																																																																														
4	Up to 30s	4	Up to 60m																																																																																																																														
5	Up to 60s	5	Up to 120m																																																																																																																														
6	Up to 120s	6	Up to 240m																																																																																																																														
ST-110/112																																																																																																																																	
Switch S1	Time Ranges																																																																																																																																
1.8s	- Up to 1.8s																																																																																																																																
7.5s	- Up to 7.5s																																																																																																																																
15s	- Up to 15s																																																																																																																																
30s	- Up to 30s																																																																																																																																
60s	- Up to 60s																																																																																																																																
120s	- Up to 120s																																																																																																																																
Switch S1	Time Ranges																																																																																																																																
220s	- Up to 220s																																																																																																																																
7.5m	- Up to 7.5m																																																																																																																																
15m	- Up to 15m																																																																																																																																
60m	- Up to 60m																																																																																																																																
120m	- Up to 120m																																																																																																																																
240m	- Up to 240m																																																																																																																																
Ordering Code Example	TYPE MODEL VOLTAGE POWER SUPPLY RELAY CONTACTS ST 100 / 230V AC - * - *	TYPE MODEL VOLTAGE POWER SUPPLY RELAY CONTACTS AT 100 / 230V AC - *	TYPE MODEL VOLTAGE POWER SUPPLY RELAY CONTACTS ST 105 / 230V AC - * - *	TYPE MODEL VOLTAGE POWER SUPPLY RELAY CONTACTS ST 108 / 230V AC - * - *	TYPE MODEL VOLTAGE POWER SUPPLY RELAY CONTACTS ST 110 / 230V AC - * - *																																																																																																																												

ELECTRONIC TIMERS



Type	Electronic Reset Timer	Star-Delta Timer	Star-Delta Timer	Unequal Cycling Timer	Unequal Cycling Timer																																																
Code	AT110	ST130	AT130	ST200/ST201/ST202/ST203	AT200																																																
Features	<ul style="list-style-type: none"> Programmable functions: Delayed ON, Interval (one shot), both with hold or pulse reset 18 overlapping programmable time ranges from 0,2 seconds to 100 hours, achieved by: <ul style="list-style-type: none"> 3 programmable time ranges: seconds, minutes, hours 6 programmable time scales for each of 3 time ranges Time Setting on calibrated scale(10 -100%) High speed electronic reset and high repetitive accuracy Direct interface with DC three-wire NPN/PNP sensors, with reset input for either PNP or NPN in the same unit Power ON, Relay ON and reset LED's Flashing Power ON LED when unit is timing Microprocessor technology incorporated 5A SPDT or DPDT relay output 	<ul style="list-style-type: none"> Relay de-energises to "centre-off" position for failsafe operation Adjustable time range of 0-60 seconds Incorporates 75 millisecond pause time to prevent overlapping of Star and Delta switching LED indication of relay output status, i.e.: Star or Delta mode Two relay method for interlocking of contacts ensuring break before make 5A relay output Rated for continuous operation 	<ul style="list-style-type: none"> Relay de-energises to "centre-off" position for failsafe operation Adjustable Star Time range of up to 60 seconds Fixed 75/50 millisecond pause time to prevent overlapping of Star and Delta switching LED indication of relay output status i.e. Star or Delta mode Two SPDT relays with neutral centre position ensure break before make Microprocessor technology incorporated 5A SPDT relay output Rated for continuous operation 	<ul style="list-style-type: none"> Programmable OFF-cycle first or ON-cycle first Programmable in 6 overlapping time ranges Extended time ranges available up to 25 hours or 200 hours on special order Separate off/on time adjustment on calibrated scale, 0-100% High repetitive accuracy 5A DPDT relay output (10A SPDT offered on request) <table border="1"> <tr> <th>Timer</th> <th>T1</th> <th>T2</th> </tr> <tr> <td>ST200</td> <td>A</td> <td>A</td> </tr> <tr> <td>ST201</td> <td>A</td> <td>B</td> </tr> <tr> <td>ST202</td> <td>B</td> <td>B</td> </tr> <tr> <td>ST203</td> <td>B</td> <td>A</td> </tr> </table>	Timer	T1	T2	ST200	A	A	ST201	A	B	ST202	B	B	ST203	B	A	<ul style="list-style-type: none"> Programmable for either OFF cycle first or ON-cycle first 12 overlapping programmable time ranges from 0,2 seconds to 4 hours High repetitive accuracy Power ON and Relay ON LED's Flashing Power ON LED when unit is timing (flash rate increases when relay is about to switch) Microprocessor technology incorporated 5A SPDT or DPDT relay output. Separate OFF/ON time range selection and time adjustments on calibrated scales, 0-100% Link Y1/Y2 to Y3 for minutes Link Y3 to Y4 for "On" first 																																	
Timer	T1	T2																																																			
ST200	A	A																																																			
ST201	A	B																																																			
ST202	B	B																																																			
ST203	B	A																																																			
Connection Diagram																																																					
Specifications	<p>POWER SUPPLY AC: Supply voltage: 12, 24, 115, 230, 400, 525V 2kV Galvanic isolation Power Consumption: 2VA (approx) Tolerance: ±15% DC: Supply Voltage: 48, 60, 110V Power Consumption: 30mA (approx) Tolerance: ±15% AC/DC: Supply Voltage: 12/24V Power Consumption: 100mA (approx) Tolerance: ±15%</p> <p>RESET INPUT Input type: NPN Sensor, PNP Sensor, Potential free contact Minimum Pulse width: 4mS Open circuit Voltage: <5, 6V</p> <p>HOUSING 250V and below: 22,5mm width Above 250V: 45mm width</p> <p>RELAY Relay Options: (250, 5A)SPDT or DPDT</p> <p>DC OUTPUT Voltage tolerance: 10-24V Source Current: 10mA Setting Accuracy: 5% Repeatability: 0,5%</p> <p>TIME RANGES (STANDARD) 2: 0,2 to 2 sec, min or hrs 5: 0,5 to 5 sec, min or hrs 10: 1 to 10 sec, min or hrs 20: 2 to 20 sec, min or hrs 50: 5 to 50 sec, min or hrs 100: 10 to 100 sec, min or hrs</p>	<p>POWER SUPPLY AC: Supply voltage: 48, 60, 115, 230, 400, 415, 525V ±15% Power consumption: 3VA (approx), 6VA for 415, 525V (approx) AC Reactive: Supply voltage: 230V (90-250V) DC: Supply voltage: 10-30V AC/DC, 48, 60, 110V DC ±10% Isolation: no galvanic isolation Power consumption: 100mA for 10-30V AC/DC, 30mA for higher ranges</p> <p>RESET Power supply to be interrupted for at least 1 second</p> <p>TIME SETTINGS 0 - 60 seconds adjustable</p> <p>PAUSE TIMER Approximately 75 milliseconds ±10%</p>	<p>POWER SUPPLY AC Transformer: Supply Voltage: 12, 24, 115, 230, 400, 525V ±15% 2kV galvanic isolation Power consumption: 2VA, 6VA (approx) AC Reactive: Supply voltage: 230V (90-250V) Power consumption: 100mA DC: Supply voltage: 48, 60, 110V Power Consumption: 30mA ±15% AC/DC: Supply voltage: 12/24V Power consumption; 100mA ±15%</p> <p>HOUSING 250V and below: 22,5mm width Above 250V: 45mm width</p> <p>RELAY: Relay Options (250V, 5A): SPDT (1x SPST for Delta and 1x SPST for Star)</p> <p>RESET Power supply to be interrupted for at least 1 second</p> <p>PAUSE TIME 75 milliseconds</p> <table border="1"> <thead> <tr> <th colspan="2">STAR TIME ADJUSTMENT</th> </tr> <tr> <th>SPDT FUNCTION</th> <th></th> </tr> </thead> <tbody> <tr> <td>S1</td> <td>60s Delay / 75ms Pause</td> </tr> <tr> <td>S2</td> <td>30s Delay / 75ms Pause</td> </tr> <tr> <td>S3</td> <td>60s Delay / 50ms Pause</td> </tr> <tr> <td>S4</td> <td>30s Delay / 50ms Pause</td> </tr> </tbody> </table>	STAR TIME ADJUSTMENT		SPDT FUNCTION		S1	60s Delay / 75ms Pause	S2	30s Delay / 75ms Pause	S3	60s Delay / 50ms Pause	S4	30s Delay / 50ms Pause	<p>POWER SUPPLY AC: Supply voltage: 230, 400, 415, 525V ±15% AC Reactive: Supply voltage: 230V (90-250V) Power consumption: 3VA, 6VA for 415, 525V (approx) DC: Supply voltage: 48, 60, 110V DC ±15% Power consumption: 30mA AC/DC: Supply voltage: 10-30V AC/DC. Power consumption: 100mA</p> <p>RESET Power supply to be interrupted for at least 0,5 seconds</p> <p>Extended time ranges available on special order: 6, 12,5, 25, 50, 100 and 200 hours</p> <table border="1"> <thead> <tr> <th colspan="2">A</th> </tr> <tr> <th>Switch Position</th> <th>Time Ranges</th> </tr> </thead> <tbody> <tr> <td>1</td> <td>- Up to 1,8s</td> </tr> <tr> <td>2</td> <td>- Up to 7,5s</td> </tr> <tr> <td>3</td> <td>- Up to 15s</td> </tr> <tr> <td>4</td> <td>- Up to 30s</td> </tr> <tr> <td>5</td> <td>- Up to 60s</td> </tr> <tr> <td>6</td> <td>- Up to 120s</td> </tr> </tbody> </table> <table border="1"> <thead> <tr> <th colspan="2">B</th> </tr> <tr> <th>Switch Position</th> <th>Time Ranges</th> </tr> </thead> <tbody> <tr> <td>7</td> <td>- Up to 220s</td> </tr> <tr> <td>8</td> <td>- Up to 7,5m</td> </tr> <tr> <td>9</td> <td>- Up to 15m</td> </tr> <tr> <td>10</td> <td>- Up to 60m</td> </tr> <tr> <td>11</td> <td>- Up to 120m</td> </tr> <tr> <td>12</td> <td>- Up to 240m</td> </tr> </tbody> </table>	A		Switch Position	Time Ranges	1	- Up to 1,8s	2	- Up to 7,5s	3	- Up to 15s	4	- Up to 30s	5	- Up to 60s	6	- Up to 120s	B		Switch Position	Time Ranges	7	- Up to 220s	8	- Up to 7,5m	9	- Up to 15m	10	- Up to 60m	11	- Up to 120m	12	- Up to 240m	<p>POWER SUPPLY AC: Supply voltage: 12, 24, 115, 230, 400, 525V 2kV Galvanic isolation Power Consumption: 2VA, 6VA (approx) Tolerance: ±15% AC Reactive: Supply voltage: 230V (90-250V) Power Consumption: 100mA DC: Supply Voltage: 48, 60, 110V Power consumption: 30mA Tolerance: ±15% AC/DC: Supply voltage: 12/24V Power consumption: 100mA Tolerance: ±15%</p> <p>HOUSING 250V and below: 22,5mm width Above: 45mm width</p> <p>RELAY Relay options (250V, 5A): SPDT, DPDT</p> <p>TIME SPECIFICATION Setting Accuracy 5% Repeatability 0.5%</p> <p>TIME RANGES (STANDARD) 2: 0,2 to 2 sec or min 6: 0,6 to 6 sec or min 20: 2 to 20 sec or min 60: 6 to 60 sec or min 120: 12 to 120 sec or min 240: 24 to 240 sec or min</p>				
STAR TIME ADJUSTMENT																																																					
SPDT FUNCTION																																																					
S1	60s Delay / 75ms Pause																																																				
S2	30s Delay / 75ms Pause																																																				
S3	60s Delay / 50ms Pause																																																				
S4	30s Delay / 50ms Pause																																																				
A																																																					
Switch Position	Time Ranges																																																				
1	- Up to 1,8s																																																				
2	- Up to 7,5s																																																				
3	- Up to 15s																																																				
4	- Up to 30s																																																				
5	- Up to 60s																																																				
6	- Up to 120s																																																				
B																																																					
Switch Position	Time Ranges																																																				
7	- Up to 220s																																																				
8	- Up to 7,5m																																																				
9	- Up to 15m																																																				
10	- Up to 60m																																																				
11	- Up to 120m																																																				
12	- Up to 240m																																																				
Ordering Code Example	<table border="1"> <tr> <th>TYPE</th> <th>MODEL</th> <th>VOLTAGE</th> <th>POWER SUPPLY</th> <th>RELAY CONTACTS</th> </tr> <tr> <td>AT</td> <td>110</td> <td>230V</td> <td>AC</td> <td>- *</td> </tr> </table>	TYPE	MODEL	VOLTAGE	POWER SUPPLY	RELAY CONTACTS	AT	110	230V	AC	- *	<table border="1"> <tr> <th>TYPE</th> <th>MODEL</th> <th>VOLTAGE</th> <th>POWER SUPPLY</th> </tr> <tr> <td>ST</td> <td>130</td> <td>230V</td> <td>AC</td> </tr> </table>	TYPE	MODEL	VOLTAGE	POWER SUPPLY	ST	130	230V	AC	<table border="1"> <tr> <th>TYPE</th> <th>MODEL</th> <th>VOLTAGE</th> <th>POWER SUPPLY</th> <th>STAR TIME</th> </tr> <tr> <td>AT</td> <td>130</td> <td>230V</td> <td>AC</td> <td>- S1</td> </tr> </table>	TYPE	MODEL	VOLTAGE	POWER SUPPLY	STAR TIME	AT	130	230V	AC	- S1	<table border="1"> <tr> <th>TYPE</th> <th>MODEL</th> <th>VOLTAGE</th> <th>POWER SUPPLY</th> <th>RELAY CONTACTS</th> </tr> <tr> <td>ST</td> <td>200</td> <td>230V</td> <td>AC</td> <td>-*** *</td> </tr> </table>	TYPE	MODEL	VOLTAGE	POWER SUPPLY	RELAY CONTACTS	ST	200	230V	AC	-*** *	<table border="1"> <tr> <th>TYPE</th> <th>MODEL</th> <th>VOLTAGE</th> <th>POWER SUPPLY</th> <th>RELAY CONTACTS</th> </tr> <tr> <td>AT</td> <td>200</td> <td>230V</td> <td>AC</td> <td>- *</td> </tr> </table>	TYPE	MODEL	VOLTAGE	POWER SUPPLY	RELAY CONTACTS	AT	200	230V	AC	- *
TYPE	MODEL	VOLTAGE	POWER SUPPLY	RELAY CONTACTS																																																	
AT	110	230V	AC	- *																																																	
TYPE	MODEL	VOLTAGE	POWER SUPPLY																																																		
ST	130	230V	AC																																																		
TYPE	MODEL	VOLTAGE	POWER SUPPLY	STAR TIME																																																	
AT	130	230V	AC	- S1																																																	
TYPE	MODEL	VOLTAGE	POWER SUPPLY	RELAY CONTACTS																																																	
ST	200	230V	AC	-*** *																																																	
TYPE	MODEL	VOLTAGE	POWER SUPPLY	RELAY CONTACTS																																																	
AT	200	230V	AC	- *																																																	

ELECTRONIC TIMERS

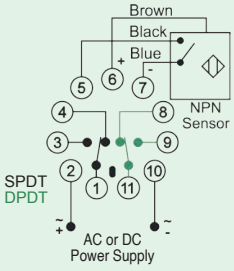
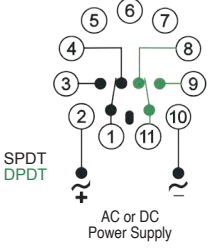
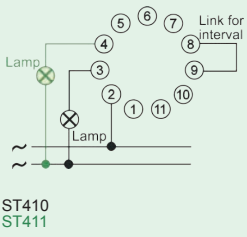
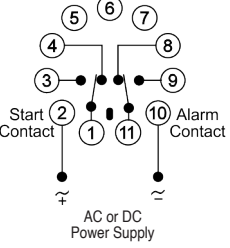
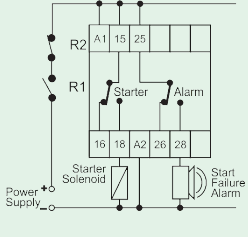
Type	Multi-function Asymmetrical Reset Timer	No Power Delay OFF Timer	AC Interval or Complementary Lamp Flasher	Multi-Start Attempt Unit	Multi-Start Attempt Unit																																																		
																																																							
Code	ST210	ST300/ST301	ST410/ST411	ST500	AT500																																																		
Features	<ul style="list-style-type: none"> 6 Programmable reset functions with hold or pulse reset or both, and power supply on reset Programmable in 6 independent overlapping time ranges up to 120 seconds Direct interface with DC three-wire NPN sensor High speed electronic reset High repetitive accuracy Time adjustment on calibrated scale, 0-100% 5A double pole relay output (10A SPDT offered on request) 	<ul style="list-style-type: none"> Internal NiCd battery back-up on ST301 Programmable in 6 independent overlapping time ranges Time adjustment on calibrated scale, 0-100% High repetitive accuracy 10A single pole or 5A double pole relay output Time ranges: <ul style="list-style-type: none"> ST300: up to 120 sec ST301: up to 240 min 	<ul style="list-style-type: none"> Programmable: continuous flashing or interval flashing Adjustable interval 1-10 secs Pulse rate of 90 flashes per minute as standard (other rated on special order) Solid state switching Switching capacity 4A, 1000W / 250V Power supply range 90V-250VAC Two wire in-line connection (ST410) or three wire in-line connection (ST411) 	<ul style="list-style-type: none"> Programmable number of starts: 3 to 8 Adjustable cranking time: 1 to 10 seconds Start failure alarm output 	<ul style="list-style-type: none"> Programmable number of start attempts: 3 to 8 Start failure alarm output Separately adjustable starter and pause times Adjustable starter time: 1 to 20 seconds Adjustable pause time: 1 to 20 seconds Power On, Start Relay and Alarm Relay LED's Microprocessor technology incorporated 5A SPDT Start Relay 5A SPDT Alarm Relay (start failure) 																																																		
Connection Diagram																																																							
Specifications	<p>POWER SUPPLY AC: Supply voltage: 12, 24, 115, 230, 400, 415, 525V ±10% Isolation (reset to power supply): 2kV Power consumption: 3VA, 6VA for 400, 415, 525V (approx) DC: Supply voltage: 10-30V 48, 60, 110V DC ±15% Isolation: no galvanic isolation Power consumption: 100mA (10-30V), 30mA for higher ranges RESET INPUT Reset time: 6ms Short circuit current: 2mA Open circuit voltage: 8,2V 12V DC Output: Voltage tolerance 10-15V DC Source current: 30mA (max)</p> <table border="1"> <thead> <tr> <th>Switch Position</th> <th>Time Ranges</th> </tr> </thead> <tbody> <tr> <td>1</td> <td>- Up to 1,8s</td> </tr> <tr> <td>2</td> <td>- Up to 7,5s</td> </tr> <tr> <td>3</td> <td>- Up to 15s</td> </tr> <tr> <td>4</td> <td>- Up to 30s</td> </tr> <tr> <td>5</td> <td>- Up to 60s</td> </tr> <tr> <td>6</td> <td>- Up to 120s</td> </tr> </tbody> </table>	Switch Position	Time Ranges	1	- Up to 1,8s	2	- Up to 7,5s	3	- Up to 15s	4	- Up to 30s	5	- Up to 60s	6	- Up to 120s	<p>POWER SUPPLY AC: Supply voltage: 12, 24, 115, 230, 400, 415, 525V ±15% Power consumption: 3VA, 6VA for 415, 525V (approx) DC: Supply voltage: 48, 60, 110V ±15% Power consumption: 30mA AC/DC: Supply voltage: 12V AC/DC and 24V AC/DC Power consumption: 100mA</p> <table border="1"> <thead> <tr> <th colspan="2">ST-300</th> </tr> <tr> <th>Switch S1</th> <th>Time Ranges</th> </tr> </thead> <tbody> <tr> <td>1,8s</td> <td>- Up to 1,8s</td> </tr> <tr> <td>7,5s</td> <td>- Up to 7,5s</td> </tr> <tr> <td>15s</td> <td>- Up to 15s</td> </tr> <tr> <td>30s</td> <td>- Up to 30s</td> </tr> <tr> <td>60s</td> <td>- Up to 60s</td> </tr> <tr> <td>120s</td> <td>- Up to 120s</td> </tr> </tbody> </table> <table border="1"> <thead> <tr> <th colspan="2">ST301</th> </tr> <tr> <th>Switch Position</th> <th>Time Ranges</th> </tr> </thead> <tbody> <tr> <td>220s</td> <td>- Up to 220s</td> </tr> <tr> <td>7,5m</td> <td>- Up to 7,5m</td> </tr> <tr> <td>15m</td> <td>- Up to 15m</td> </tr> <tr> <td>60m</td> <td>- Up to 60m</td> </tr> <tr> <td>120m</td> <td>- Up to 120m</td> </tr> <tr> <td>240m</td> <td>- Up to 240m</td> </tr> </tbody> </table> <p>**I = Instantaneous Contacts</p>	ST-300		Switch S1	Time Ranges	1,8s	- Up to 1,8s	7,5s	- Up to 7,5s	15s	- Up to 15s	30s	- Up to 30s	60s	- Up to 60s	120s	- Up to 120s	ST301		Switch Position	Time Ranges	220s	- Up to 220s	7,5m	- Up to 7,5m	15m	- Up to 15m	60m	- Up to 60m	120m	- Up to 120m	240m	- Up to 240m	<p>POWER SUPPLY Supply voltage: 230 (90-250V) Supply frequency: 45-70Hz Minimum load: 15W (250VAC), 10W(110VAC) Maximum load: 1000W (250VAC), 400W (110VAC) Maximum load current: 4A continuous TIMING Flash rate: 90 flashes per minute (standard). Optional pulse rates available on special order Interval: 1-10 seconds (adjustable) RESET Power supply to be interrupted for at least 5 seconds</p>	<p>POWER SUPPLY AC: Supply voltage: 48, 60, 115, 230V ±15% Power consumption: 3VA (approx) DC: Supply voltage: 48, 60, 110V ±15% Power consumption: 30mA AC/DC: Supply voltage: 10-30V AC/DC Power consumption: 100mA RESET Power supply to be interrupted for at least 0,5 seconds NUMBER OF START 3 to 8 (programmable) DURATION OF START ATTEMPT Adjustable from 1 to 10 seconds DURATION OF PAUSE Equal to set duration of start attempt</p>	<p>POWER SUPPLY AC: Supply Voltage: 12, 24, 115, 230, 400, 525V 2kV galvanic isolation Power consumption: 2VA (approx) Tolerance: ±15% AC Reactive: Supply voltage: 230 (90-250V) Power Consumption: 2VA DC: Supply Voltage: 48, 60, 110V Power consumption: 30mA Tolerance: ±15% AC/DC: Supply voltage: 12/24V Power consumption: 100mA Tolerance: ±15% HOUSING 250V and below: 22.5mm width Above 250V: 45mm width ALARM RELAY Contact rating 250V, 5A SPDT STARTER RELAY Contact rating 250V, 5A SPDT START ATTEMPTS Number of Start Attempts: 3 to 8 Duration of Start Attempts: Adjustable from 1 to 20 secs Duration of Pause between Start Attempts: Adjustable from 1 to 20 secs</p>				
Switch Position	Time Ranges																																																						
1	- Up to 1,8s																																																						
2	- Up to 7,5s																																																						
3	- Up to 15s																																																						
4	- Up to 30s																																																						
5	- Up to 60s																																																						
6	- Up to 120s																																																						
ST-300																																																							
Switch S1	Time Ranges																																																						
1,8s	- Up to 1,8s																																																						
7,5s	- Up to 7,5s																																																						
15s	- Up to 15s																																																						
30s	- Up to 30s																																																						
60s	- Up to 60s																																																						
120s	- Up to 120s																																																						
ST301																																																							
Switch Position	Time Ranges																																																						
220s	- Up to 220s																																																						
7,5m	- Up to 7,5m																																																						
15m	- Up to 15m																																																						
60m	- Up to 60m																																																						
120m	- Up to 120m																																																						
240m	- Up to 240m																																																						
Ordering Code Example	<table border="1"> <tr> <td>TYPE</td> <td>MODEL</td> <td>VOLTAGE</td> <td>POWER SUPPLY</td> <td>RELAY CONTACTS</td> </tr> <tr> <td>ST</td> <td>210 /</td> <td>230V</td> <td>AC</td> <td>- *</td> </tr> </table>	TYPE	MODEL	VOLTAGE	POWER SUPPLY	RELAY CONTACTS	ST	210 /	230V	AC	- *	<table border="1"> <tr> <td>TYPE</td> <td>MODEL</td> <td>VOLTAGE</td> <td>POWER SUPPLY</td> <td>RELAY CONTACTS</td> </tr> <tr> <td>ST</td> <td>300 /</td> <td>230V</td> <td>AC</td> <td>-** *</td> </tr> </table>	TYPE	MODEL	VOLTAGE	POWER SUPPLY	RELAY CONTACTS	ST	300 /	230V	AC	-** *	<table border="1"> <tr> <td>TYPE</td> <td>MODEL</td> <td>VOLTAGE</td> <td>POWER SUPPLY</td> <td>RELAY CONTACTS</td> </tr> <tr> <td>ST</td> <td>410 /</td> <td>250V</td> <td>AC</td> <td>-</td> </tr> </table>	TYPE	MODEL	VOLTAGE	POWER SUPPLY	RELAY CONTACTS	ST	410 /	250V	AC	-	<table border="1"> <tr> <td>TYPE</td> <td>MODEL</td> <td>VOLTAGE</td> <td>POWER SUPPLY</td> <td>RELAY CONTACTS</td> </tr> <tr> <td>ST</td> <td>500 /</td> <td>230V</td> <td>AC</td> <td>-</td> </tr> </table>	TYPE	MODEL	VOLTAGE	POWER SUPPLY	RELAY CONTACTS	ST	500 /	230V	AC	-	<table border="1"> <tr> <td>TYPE</td> <td>MODEL</td> <td>VOLTAGE</td> <td>POWER SUPPLY</td> <td>RELAY CONTACTS</td> </tr> <tr> <td>AT</td> <td>500 /</td> <td>230V</td> <td>AC</td> <td>- SP</td> </tr> </table>	TYPE	MODEL	VOLTAGE	POWER SUPPLY	RELAY CONTACTS	AT	500 /	230V	AC	- SP
TYPE	MODEL	VOLTAGE	POWER SUPPLY	RELAY CONTACTS																																																			
ST	210 /	230V	AC	- *																																																			
TYPE	MODEL	VOLTAGE	POWER SUPPLY	RELAY CONTACTS																																																			
ST	300 /	230V	AC	-** *																																																			
TYPE	MODEL	VOLTAGE	POWER SUPPLY	RELAY CONTACTS																																																			
ST	410 /	250V	AC	-																																																			
TYPE	MODEL	VOLTAGE	POWER SUPPLY	RELAY CONTACTS																																																			
ST	500 /	230V	AC	-																																																			
TYPE	MODEL	VOLTAGE	POWER SUPPLY	RELAY CONTACTS																																																			
AT	500 /	230V	AC	- SP																																																			

*Relay contact
 SP= Single Pole
 DP= Double Pole

ELECTRONIC TIMERS

Type	Multi-Function Timer	Delayed ON / Interval (One Shot) Timer																																		
Code	48T100	48T101																																		
Features	<ul style="list-style-type: none"> • Microprocessor based • Power On LED indication • Relay operation LED indication • Programmable functions: Delay on (Pulse start); Interval (Hold/ Pulse Start); Equal Repeating (On/Off First); Signal On/ Off Delay • Start - Reset - Gate Inputs • Gate Input: When activated the unit stops timing and continues when released • Time Range 0.1s to 100hrs • DPDT relay (5A) as standard • Flashing Power LED when timing • 5 Sec Test Mode to confirm circuit operation and assist commissioning • Front dial doubles as screwdriver for adjusting controls 	<ul style="list-style-type: none"> • Microprocessor based • Power On LED indication • Relay operation LED indication • Time Range 0.1s to 100hrs • DPDT relay (5A) as standard • Flashing Power LED when timing • 5 Sec Test Mode to confirm circuit operation and assist commissioning • Front dial doubles as screwdriver for adjusting controls • Available in 8-Pin or 11-Pin Format 																																		
Connection Diagram		<div style="display: flex; justify-content: space-around;"> <div style="text-align: center;"> <p>8 Pin</p> <p>Power Supply</p> </div> <div style="text-align: center;"> <p>11 Pin</p> <p>Power Supply</p> </div> </div>																																		
Specifications	<p>Power Supply: AC Reactive: Supply Voltage: 230 (100-230VAC) Power Consumption: 3VA AC/DC: Supply Voltage: 24(24VAC/DC) DC: Supply Voltage: 12VDC Power Consumption: 1.5W Tolerance: ±10% Reset Times Input Reset: 50msec min Power Reset: 100msec min</p> <p>Timing Settings</p> <table border="1"> <thead> <tr> <th rowspan="2">Range</th> <th colspan="2">Scale Multiplier</th> </tr> <tr> <th>X1</th> <th>X10</th> </tr> </thead> <tbody> <tr> <td>Sec</td> <td>0.1 - 1sec</td> <td>1 - 10sec</td> </tr> <tr> <td>Min</td> <td>0.1 - 1min</td> <td>1 - 10 min</td> </tr> <tr> <td>Hrs</td> <td>0.1 - 1hrs</td> <td>1 - 10 hrs</td> </tr> <tr> <td>10Hrst</td> <td>1 - 10hrs</td> <td>10 - 100hrs</td> </tr> </tbody> </table> <p>General Specifications: Enclosure protection rating: IP40 Size: 48 x 48 x 67 Weight: ± 100gm (approx) Only 11Pin</p>	Range	Scale Multiplier		X1	X10	Sec	0.1 - 1sec	1 - 10sec	Min	0.1 - 1min	1 - 10 min	Hrs	0.1 - 1hrs	1 - 10 hrs	10Hrst	1 - 10hrs	10 - 100hrs	<p>Power Supply: AC Reactive: Supply Voltage: 230(100-230VAC) Power Consumption: 3VA AC/DC: Supply Voltage: 24(24VAC/DC) DC: Supply Voltage: 12VDC Power Consumption: 1.5W Tolerance: ±10% Reset Times Input Reset: 50msec min Power Reset: 100msec min</p> <p>Timing Settings</p> <table border="1"> <thead> <tr> <th rowspan="2">Range</th> <th colspan="2">Scale Multiplier</th> </tr> <tr> <th>X1</th> <th>X10</th> </tr> </thead> <tbody> <tr> <td>Sec</td> <td>0.1 - 1sec</td> <td>1 - 10sec</td> </tr> <tr> <td>Min</td> <td>0.1 - 1min</td> <td>1 - 10 min</td> </tr> <tr> <td>Hrs</td> <td>0.1 - 1hrs</td> <td>1 - 10 hrs</td> </tr> <tr> <td>10Hrst</td> <td>1 - 10hrs</td> <td>10 - 100hrs</td> </tr> </tbody> </table> <p>General Specifications: Enclosure protection rating: IP40 Size: 48 x 48 x 67 Weight: ± 100gm (approx) *Add to code 08 = 8Pin *Add to code 11 = 11Pin</p>	Range	Scale Multiplier		X1	X10	Sec	0.1 - 1sec	1 - 10sec	Min	0.1 - 1min	1 - 10 min	Hrs	0.1 - 1hrs	1 - 10 hrs	10Hrst	1 - 10hrs	10 - 100hrs
Range	Scale Multiplier																																			
	X1	X10																																		
Sec	0.1 - 1sec	1 - 10sec																																		
Min	0.1 - 1min	1 - 10 min																																		
Hrs	0.1 - 1hrs	1 - 10 hrs																																		
10Hrst	1 - 10hrs	10 - 100hrs																																		
Range	Scale Multiplier																																			
	X1	X10																																		
Sec	0.1 - 1sec	1 - 10sec																																		
Min	0.1 - 1min	1 - 10 min																																		
Hrs	0.1 - 1hrs	1 - 10 hrs																																		
10Hrst	1 - 10hrs	10 - 100hrs																																		
Ordering Code Example	TYPE MODEL TYPE VOLTAGE 48 T100 — 11 — 230V	TYPE MODEL TYPE VOLTAGE 48 T101 — * — 230V																																		

SLIMLINE HOUSING

Housing colour: Base: Grey
Cover: Blue
Housing material: Polycarbonate

A-LINE & PUMP MONITOR PROTECTION HOUSING

Housing colour: Beige
Housing material: Nylon 66





48 X 48 TIMER HOUSING

Housing colour: Beige
Housing material: ABS/ Polycarbonate

Clips for Slimline consists of 10 sets

RMC
10 Sets / Pack



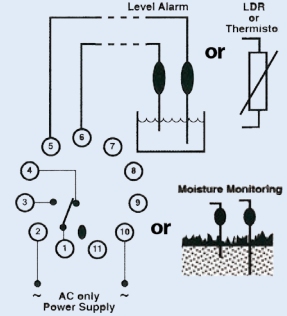
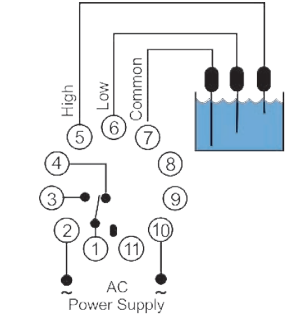
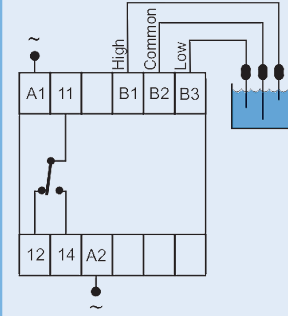
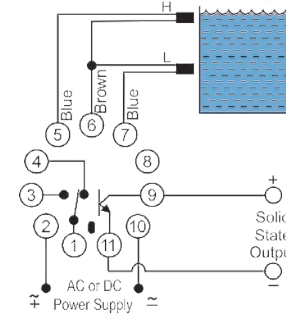

PROCESS CONTROLLERS

Type	Control Module for resistive Sensors	Liquid Level Control Module	Liquid Level Controller	Level Control Module for NAMUR Sensor																																								
																																												
Code	SC100	SC130	AC130	SC230																																								
Features	<ul style="list-style-type: none"> Senses conductivity between two probe terminals providing a relay output if conductivity exceeds a set limit AC modulation of probe signal to prevent plating and electrolytic corrosion Low voltage probe signal for human safety Adjustable sensitivity from 15k to 500k Ohm 10A SPDT relay output <p>Possible Applications:</p> <ul style="list-style-type: none"> Liquid Level Control Flame Detection / Daylight Switching Temperature Control Soil Moisture Monitoring Remote Start/Stop 	<ul style="list-style-type: none"> Programmable for charging and discharging operation AC modulation of probe signal to prevent plating and electrolytic corrosion Low voltage, probe signal for human safety Adjustable sensitivity DC or AC power supply option 10A SPDT relay output 	<ul style="list-style-type: none"> Programmable for charging and discharging operation AC modulation of probe signal to prevent plating and electrolytic corrosion Low voltage, probe signal for human safety Adjustable sensitivity Power ON and RELAY ON LED's 5A SPDT or DPDT relay output 	<ul style="list-style-type: none"> Interfaces with industrial standard NAMUR sensors (inductive or capacitive) Low power sensor signal to DIN19234 Programmable charge or discharge modes Programmable single or double sensor selection Independent indication of each sensor status Separate cable fault indication for each sensor Failsafe operation under cable fault conditions Direct interface with solid state relay Protected NPN output for direct interface with PLC's or counters 10A SPDT relay output DC or AC power supply option 																																								
Connection Diagram																																												
Specifications	<p>POWER SUPPLY AC: (AC only - see SC130 for DC applications) Supply voltage: 12, 24, 115, 230, 400, 415, 525V AC ±15% Isolation (probe input to power supply): 2kV Power consumption: 3VA, 6VA for 415, 525V (approx)</p> <p>PROBE INPUT Sensitivity: approx. 15-500k Ohm (adjustable) Probe voltage: 12V AC Probe frequency: 50Hz</p>	<p>POWER SUPPLY AC: Supply voltage: 12, 24, 115, 230, 400, 415, 525V ±15% Isolation (probe input to power supply): 2kV Power Consumption: 3VA, 6VA for 415, 525V (approx) DC: Supply voltage: 10-30V, 48, 60, 110V ±15% Isolation: no galvanic isolation Power consumption: 100mA (10-30V), 30mA for higher ranges</p> <p>LEVEL SENSING INPUT Probe voltage: 4V AC Probe frequency: 100Hz Sensitivity: 0 - 50kOhm (adjustable) Response time: 0,5 seconds</p> <p>*For Probe parts, see page 32</p>	<p>POWER SUPPLY AC: Transformer (2kV galvanic isolation): Supply Voltage: 12, 24, 115, 230, 400, 525VAC Power consumption: 2VA (approx) Tolerance: ±15% DC: Supply voltage: 12, 24, 48, 60, 110V Power Consumption: 30mA (approx) Power Consumption: 100mA (approx) Tolerance: ±15%</p> <p>HOUSING 250V and below: 22,5mm width Above 250V: 45mm width</p> <p>LEVEL SENSING INPUT Probe voltage: 4V AC Probe frequency: 100Hz Sensitivity: 0 to 100kOhm (adjustable) Response: 0.5 seconds</p> <p>RELAY Relay Contacts (250V, 5A): SPDT, DPDT.</p> <p>*For probe parts see page 32</p>	<p>POWER SUPPLY AC: Supply voltage: 12, 24, 115, 230, 400, 415, 525 ±15% Isolation (sensor input to power supply): 2kV Power consumption: 3VA, 6VA for 415, 525V (approx) DC: Supply voltage: 10-30V, 48, 60, 110V ±15% Isolation: no galvanic isolation Power Consumption: 100mA (10-30V), 30mA for higher ranges</p> <p>SENSOR INPUT Type NAMUR (DIN 19234) Maximum Sensing Speed: 25Hz (when using relay output) Short Circuit Current: 20mA DC Open Circuit Voltage: 8,2V DC</p> <p>OUTPUTS (SP) NPN Open Connector (9,11) Solid State Relay Drive (8,9) C/O (1,3,4)</p> <p>If DP Contacts, no solid state O/P</p>																																								
*Relay contact SP= Single Pole DP= Double Pole																																												
Ordering Code Example	<table border="1"> <tr> <th>TYPE</th> <th>MODEL</th> <th>VOLTAGE</th> <th>POWER SUPPLY</th> <th>RELAY CONTACTS</th> </tr> <tr> <td>SC</td> <td>100</td> <td>230V</td> <td>AC</td> <td>*</td> </tr> </table>	TYPE	MODEL	VOLTAGE	POWER SUPPLY	RELAY CONTACTS	SC	100	230V	AC	*	<table border="1"> <tr> <th>TYPE</th> <th>MODEL</th> <th>VOLTAGE</th> <th>POWER SUPPLY</th> <th>RELAY CONTACTS</th> </tr> <tr> <td>SC</td> <td>130</td> <td>230V</td> <td>AC</td> <td>*</td> </tr> </table>	TYPE	MODEL	VOLTAGE	POWER SUPPLY	RELAY CONTACTS	SC	130	230V	AC	*	<table border="1"> <tr> <th>TYPE</th> <th>MODEL</th> <th>VOLTAGE</th> <th>POWER SUPPLY</th> <th>RELAY CONTACTS</th> </tr> <tr> <td>AC</td> <td>130</td> <td>230V</td> <td>AC</td> <td>*</td> </tr> </table>	TYPE	MODEL	VOLTAGE	POWER SUPPLY	RELAY CONTACTS	AC	130	230V	AC	*	<table border="1"> <tr> <th>TYPE</th> <th>MODEL</th> <th>VOLTAGE</th> <th>POWER SUPPLY</th> <th>RELAY CONTACTS</th> </tr> <tr> <td>SC</td> <td>230</td> <td>230V</td> <td>AC</td> <td>*</td> </tr> </table>	TYPE	MODEL	VOLTAGE	POWER SUPPLY	RELAY CONTACTS	SC	230	230V	AC	*
TYPE	MODEL	VOLTAGE	POWER SUPPLY	RELAY CONTACTS																																								
SC	100	230V	AC	*																																								
TYPE	MODEL	VOLTAGE	POWER SUPPLY	RELAY CONTACTS																																								
SC	130	230V	AC	*																																								
TYPE	MODEL	VOLTAGE	POWER SUPPLY	RELAY CONTACTS																																								
AC	130	230V	AC	*																																								
TYPE	MODEL	VOLTAGE	POWER SUPPLY	RELAY CONTACTS																																								
SC	230	230V	AC	*																																								

PROCESS CONTROLLERS

Type	Control Module for NAMUR Sensor	Intrinsically Safe Control Module for NAMUR Sensor	3-Wire DC Sensor Interface Relay Module	Tachometer Relay												
Code	SC300	SC301	SC314	SC320												
Features	<ul style="list-style-type: none"> • Direct interface with Namur two-wire proximity sensors (inductive, capacitive and opto-electronic) • Sensor cable fault detection with LED indication • Proximity switching in hostile supply voltage environments (transients, surges) • High reliability proximity switching compared to limit switches • Cost efficient sensor and module replacement • Impervious to interference between sensor and amplifier over long cable runs • Low power sensor signal to DIN19234 • 10A single pole or 2 x 5A double pole relay outputs 	<ul style="list-style-type: none"> • Intrinsically safe classification: (Ex ib) Gr 2C, T6. • Direct interface with Namur two wire proximity switches • Failsafe operation • Sensor cable fault detection and indication • Low power sensor signal to DIN19234 • SPST relay outputs 	<ul style="list-style-type: none"> • Interfaces with all types of 3-wire NPN or PNP DC sensors (inductive, capacitive and optoelectronic) • LED indication of relay status • Robust power supply • Cost efficient interface for DC sensors in AC environments • Cost efficient module replacement • 10A SPDT relay output 	<ul style="list-style-type: none"> • Direct interface with Namur two-wire proximity sensors or limit switches • Low power sensor signal to DIN19234 • Sensor cable fault indication • Programmable speed ranges: 10 RPM to 10 000 RPM • Programmable for over-speed or under-speed detection • 0 to 1mA proportional output for tachometer instruments • 4-20mA available on request • Speed set point adjustable on calibrated scale 0-100% • Start-up delay • 10A SPDT relay output <p>Note: Analogue output not available when DP option selected</p>												
Connection Diagram																
Specifications	<p>POWER SUPPLY AC: Supply voltage: 12, 24, 115, 230, 400, 415, 525V ±15% Isolation (sensor input to power supply): 2kV Power consumption: 3VA, 6VA for 415, 525V (approx) DC: Supply voltage: 10-30V, 48, 60, 110V ±15% Isolation: no galvanic isolation Power consumption: 100mA (10-30V), 30mA for higher ranges SENSOR INPUT Type: NAMUR (DIN 19234) Maximum Sensing Speed: 25Hz Short Circuit Current: 20mA DC Open circuit voltage: 8.2V DC</p>	<p>POWER SUPPLY AC: Supply voltage: 115, 230V ±15% Isolation (sensor input to power supply): 2kV Power consumption: 3VA approximately DC: Supply voltage: 24V ±15% Isolation: no galvanic isolation Power consumption: 100mA SENSOR INPUT Type: Namur (DIN 19234) Quiescent Voltage: <8.2V DC Short circuit current: < 25mA Max External Capacitance: < 300nF (AC supply), < 700nF (DC supply) Max External Inductance: < 2mH Relay options: SPST (pins 1 & 3, NO), DPST (pins 1 & 3 NO / pins 11 & 9, NO) Maximum relay current: 5A Maximum relay voltage: 250V Maximum product of relay current and voltage: 100VA Internal fuse rating: (AC supply) 100mA, 250V</p>	<p>SUPPLY VOLTAGE AC: Supply Voltage: 12, 24, 115, 230, 400, 415, 525V ±15% Isolation (sensor input to power supply): 2kV Power consumption: 3VA, 6VA for 415, 525V (approx) DC OUTPUT SUPPLY FOR SENSORS 10-15V at 30mA SENSORS INPUT: (PNP pin 5, NPN pin 8) Each sensor must be able to conduct at least 80mA to operate the modules internal relay Maximum switching speed: 25Hz (when using relay output)</p>	<p>POWER SUPPLY AC: Supply voltage: 12, 24, 115, 230, 400, 415, 525V ±15% Isolation (sensor input to power supply): 2kV Power consumption: 3VA, 6VA for 415, 525V (approx) DC: Supply voltage: 10-30V, 48, 60, 110V ±15% Isolation: no galvanic isolation Power consumption: 100mA (10-30V), 30mA for higher ranges SENSOR INPUT Type: Namur (DIN 19234) Short Circuit Current: 20mA DC Open Circuit Voltage: 8.2V DC Hysteresis: 10% (fixed) Repeatability: 1% Start-up delay: approximately 10 seconds (Available 0-15 seconds on special order) Analogue output: 0-1mA DC** (0-20mA or 4-20mA - available as an output order option) Maximum load: 7k Ohm Accuracy: 5% of full scale</p> <table border="1"> <thead> <tr> <th>Speed Range</th> <th>Approximate Response time</th> </tr> </thead> <tbody> <tr> <td>10-100 RPM</td> <td>10 seconds</td> </tr> <tr> <td>30-300 RPM</td> <td>10 seconds</td> </tr> <tr> <td>100-1 000 RPM</td> <td>1 second</td> </tr> <tr> <td>300-3 000 RPM</td> <td>1 second</td> </tr> <tr> <td>1 000- 10 000 RPM</td> <td>1 second</td> </tr> </tbody> </table>	Speed Range	Approximate Response time	10-100 RPM	10 seconds	30-300 RPM	10 seconds	100-1 000 RPM	1 second	300-3 000 RPM	1 second	1 000- 10 000 RPM	1 second
Speed Range	Approximate Response time															
10-100 RPM	10 seconds															
30-300 RPM	10 seconds															
100-1 000 RPM	1 second															
300-3 000 RPM	1 second															
1 000- 10 000 RPM	1 second															
*Relay contact SP= Single Pole DP= Double Pole																
Ordering Code Example	TYPE MODEL VOLTAGE POWER SUPPLY RELAY CONTACTS SC 300 / 230V AC - *	TYPE MODEL VOLTAGE POWER SUPPLY RELAY CONTACTS SC 301 / 230V AC - *	TYPE MODEL VOLTAGE POWER SUPPLY RELAY CONTACTS SC 314 / 230V AC - SP	TYPE MODEL VOLTAGE POWER SUPPLY OUTPUT RELAY CONTACTS SC 320 / 230V AC / ** - *												



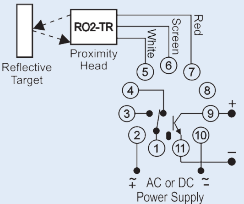
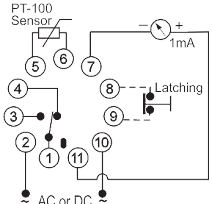
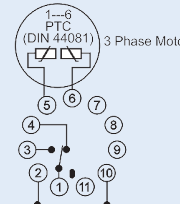
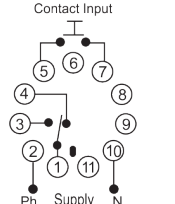

PROCESS CONTROLLERS

Type	Opto-electronic Control Unit	Temperature Control Module	Thermistor Motor Protection Module	Flip Flop Relay with/without Memory																														
																																		
Code	SC410/SC411	SC501	SC510/SC511	SC610/SC611																														
Features	<ul style="list-style-type: none"> Directly interfaces with the R02 Detector range of rectangular and tubular opto-electronic sensors 10 metre sensing distance with the appropriate barrier heads Programmable for dark or light response Adjustable on and off response delay of 0-5 seconds Signal modulated beam to stop foreign light source interference Adjustable light intensity High speed solid state (NPN) open collector output Direct interface with solid state relays Opto sensor cable fault detection (SC411 only) 10A SPDT relay output <p>Note: Solid state O/P not available when DP option selected</p>	<ul style="list-style-type: none"> Interfaces with industrial standard PT-100 temperature sensors Six programmable overlapping temp. ranges between -50 - 300°C Programmable for over and under temperature Temperature level adjustment on calibrated scale 0 - 100% High repetitive accuracy Programmable inversion of relay output for fail-to-safe operation 0 to 1mA proportional output for each temperature range Proportional output is limited to 1,2 mA to protect analogue instruments Latching on under-temperature or over-temperature (programmable) 10A SPDT relay output 	<ul style="list-style-type: none"> Interfaces with PTC sensors as per DIN 44081 The SC511 has a fault latching feature, can be reset via external opening contact or via the reset button on the unit Test button to simulate fault condition on the SC511 Sensor or cable fault detection and indication with an automatic relay de-energisation for failsafe operation 10A SPDT relay output 	<ul style="list-style-type: none"> Many power supply options Direct connection of a NPN sensor (SC611) SC610 - without memory SC611 - with memory 10A SPDT or a 5A DPDT relay 																														
Connection Diagram																																		
	See page 24 for sensors. (DPDT on request)	DPDT on request. No Latching	DPDT on request	DPDT on request (SC610 Only)																														
Specifications	<p>POWER SUPPLY AC: Supply voltage: 12, 24, 115, 230, 400, 415, 525V ±15% Isolation (sensor input to power supply): 2kV Power consumption: 3VA, 6VA for 415, 525V (approx) DC: Supply voltage: 10-30V, 48, ±15% Isolation: no galvanic isolation (common negative) Power consumption: 100mA (10-30V), 30mA for higher ranges</p> <p>RESPONSE ON - Delay = 0.03 - 5 seconds (adjustable) OFF - Delay = 0.03 - 5 seconds (adjustable)</p> <p>SSR DRIVER OUTPUT (Pin 8 - 9) Max. output source current: 8mA Open circuit output voltage: 12V DC</p> <p>TRANSMITTER (Pin 6 - 7) Current pulse: 1.5A/25 microseconds Maximum wire impedance: 2,5 Ohms (use coaxial cable) Short circuit current: 20 mA (average)</p> <p>RECEIVER (Pin 5 - 6) Short circuit current: 3mA Open circuit voltage: 8.2V</p> <p>OPEN COLLECTOR TRANSISTOR OUTPUT (Pin 9-11) Type: NPN transistor Output sink current: 100mA Maximum voltage: 30V DC</p>	<p>POWER SUPPLY AC: Supply voltage: 12, 24, 115, 230, 400, 415, 525V ±15% Isolation (sensor input to power supply): 2kV Power consumption: 3VA, 6VA for 415, 525V (approx) DC: Supply voltage: 12, 24V 15% Isolation: no galvanic isolation Power consumption: 100mA</p> <p>CONNECTION CABLE 2 - core, unshielded. Resistance of long cables affect temp. accuracy (Approx. 1°C per 0.3 ohms)</p> <p>SENSOR INPUT Type PT-100 resistive temperature sensor Short-circuit current: 1mA Open-circuit voltage: 220mV</p> <p>TEMPERATURE SENSING RANGE - Repetitive accuracy: 1%</p> <table border="1"> <thead> <tr> <th>RANGE</th> <th>S1</th> </tr> </thead> <tbody> <tr> <td>-50 to 50 C</td> <td>1</td> </tr> <tr> <td>0 to 100 C</td> <td>2</td> </tr> <tr> <td>50 to 150 C</td> <td>3</td> </tr> <tr> <td>100 to 200 C</td> <td>4</td> </tr> <tr> <td>150 to 250 C</td> <td>5</td> </tr> <tr> <td>200 to 300 C</td> <td>6</td> </tr> </tbody> </table> <p>ANALOGUE OUTPUT Rating 0 to 1mA (proportional) 4-20mA available as an order option on any one range Maximum voltage between pins 7 and 11 (pin 11 positive): 12V DC Maximum load: 7k Ohm. Current limits at 1.2mA to protect analogue instruments</p>	RANGE	S1	-50 to 50 C	1	0 to 100 C	2	50 to 150 C	3	100 to 200 C	4	150 to 250 C	5	200 to 300 C	6	<p>POWER SUPPLY AC: Supply voltage: 12, 24, 115, 230, 400, 415, 525V ±15% Power consumption: 3VA, 6VA for 415, 525V (approx) DC: Supply voltage: 10-30V, 48, 60, 110V ±15% Isolation: no galvanic isolation Power consumption: 100mA for 10-30V, 30mA for 48V and higher</p> <p>SENSOR INPUT Type: PTC sensor as per DIN 44081 Input impedance: 2200 Ohms Open-circuit voltage: <=2.5V Short circuit current: 1mA (max)</p> <p>MEASURING CHARACTERISTICS OF THE SENSOR Maximum cold resistance of PTC sensor: 1500ohms (i.e. 1 to 6 sensors can be connected) Triggering threshold: 3100 Ohms ±10% Recovery threshold: 1650 Ohms ±10% Short-circuit detection: < 20ohms Open-circuit detection: 10k ±10% Repetitive accuracy: 0,5% Response Time: 50 milliseconds</p>	<p>POWER SUPPLY AC: Supply voltage: 12, 24, 115, 230, 400, ±15% Isolation (reset to power supply): 2kV Power consumption: 3VA (approx) DC: Supply voltage: 12, 24, 48, 60, 110V ±15% Isolation: no galvanic isolation Power consumption: 100mA for 12V and 24V, 30mA for 48V and higher</p> <p>12V DC Output: Voltage tolerance: 10-15V DC. Source Current: 50mA (max.)</p> <p>INPUT</p> <table border="1"> <thead> <tr> <th colspan="2">SC-610</th> </tr> </thead> <tbody> <tr> <td>Short circuit current:</td> <td>8.5mA</td> </tr> <tr> <td>Open Circuit Voltage:</td> <td>8.2V</td> </tr> <tr> <td>Input reset speed:</td> <td>20 milliseconds.</td> </tr> </tbody> </table> <table border="1"> <thead> <tr> <th colspan="2">SC-611</th> </tr> </thead> <tbody> <tr> <td>Short circuit current:</td> <td>1mA</td> </tr> <tr> <td>Open Circuit Voltage:</td> <td>8.2V</td> </tr> <tr> <td>Input reset speed:</td> <td>10 milliseconds.</td> </tr> </tbody> </table>	SC-610		Short circuit current:	8.5mA	Open Circuit Voltage:	8.2V	Input reset speed:	20 milliseconds.	SC-611		Short circuit current:	1mA	Open Circuit Voltage:	8.2V	Input reset speed:	10 milliseconds.
RANGE	S1																																	
-50 to 50 C	1																																	
0 to 100 C	2																																	
50 to 150 C	3																																	
100 to 200 C	4																																	
150 to 250 C	5																																	
200 to 300 C	6																																	
SC-610																																		
Short circuit current:	8.5mA																																	
Open Circuit Voltage:	8.2V																																	
Input reset speed:	20 milliseconds.																																	
SC-611																																		
Short circuit current:	1mA																																	
Open Circuit Voltage:	8.2V																																	
Input reset speed:	10 milliseconds.																																	
*Relay contact SP= Single Pole DP= Double Pole																																		
Ordering Code Example	TYPE MODEL VOLTAGE POWER SUPPLY RELAY CONTACTS SC 410 / 230V AC - *	TYPE MODEL VOLTAGE POWER SUPPLY RELAY CONTACTS SC 501 / 230V AC - *	TYPE MODEL VOLTAGE POWER SUPPLY RELAY CONTACTS SC 510 / 230V AC - *	TYPE MODEL VOLTAGE POWER SUPPLY RELAY CONTACTS SC 610 / 230V AC - *																														





COUNTALINE

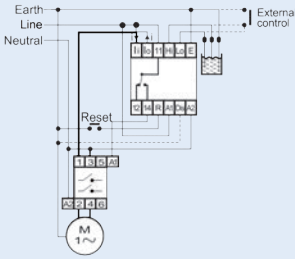
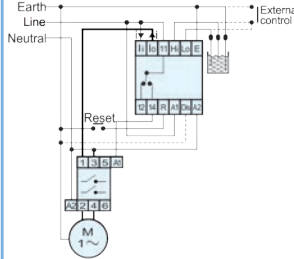
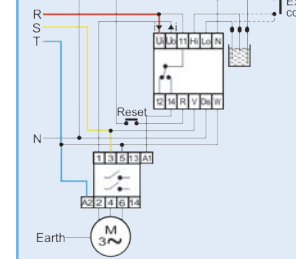
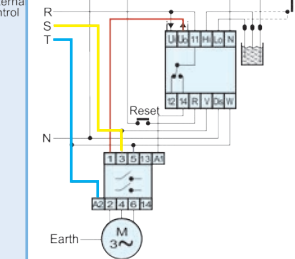



Type	Power Supply Module	Totalising Counter	Multi-function Preselect Counter	Preselect Counter
Code	SC900	CC120	SC700	CC701
Features	<ul style="list-style-type: none"> • Cost effective power supply. • A large variety of output supply options (see table below) • High input voltage ranges (up to 525V AC) • Ease of installation due to 11-pin plug-in concept 	<ul style="list-style-type: none"> • Large 6-digit LED display with leading zero suppression • High speed count input (5kHz) with positive or negative active edge (order option) • Independent low speed count input (30Hz) suitable for mechanical sensors • Reset achieved via the front panel push-button, via external switch or via NPN sensor • Gate input for ignoring high speed count input pulses • DC (NPN or PNP) or Namur sensor compatible high speed and gate inputs (order option) • 48 x 72mm panel mount housing format 	<ul style="list-style-type: none"> • High & low speed inputs in one unit • Selectable ADD, SUBTRACT or ADD/SUBTRACT count modes • Relay hold time programmable from 0,1 - 25 seconds in 0,1 seconds increments • Reset achieved via the front panel push-button, via external switch or via NPN sensors • DC (NPN or PNP) or Namur sensor compatible high speed and gate inputs (order option) • Tamperproof keylock feature for protection of programmed parameters • 11-pin plug-in format (Industrial Standard) 	<ul style="list-style-type: none"> • High & low speed inputs in one unit • Relay hold time programmable from 0,1 - 25 seconds in 0,1 second increments • Reset achieved via the front panel push-button, via external switch or via NPN sensors • DC (NPN or PNP) or Namur sensor compatible high speed input (order option) • Large 4-digit display with leading zero suppression • Separate up and down count inputs in ADD/SUBTRACT mode 1 • Separate count and count direction input in ADD/SUBTRACT mode 2 • User friendly keypad programming • 48 x 48mm (1/16 DIN) panel mount housing format
Connection Diagram				
Specifications	<p>INPUT SUPPLY VOLTAGE *AC: Supply Voltage: 12, 24, 115, 230, 400, 415, 525V 10% Isolation (input to input): 2kV **Output Voltage: 12, 24, 15, 32V Power consumption: 6VA (approx) ***Output Supply Voltage Type: AC, DC, DCRG AC Supply (±10%) Output Current: 300mA, 150mA, 100mA DC Unregulated (±10%) Output Current: 200mA, 120mA, 100mA % Ripple: <5 DCRG Regulated (±1%) Output Current: 150mA, 100mA, 80mA % Ripple: <0,5 Output Type: AC = AC DC = DC (UNREGULATED) DCRG = DC (REGULATED)</p>	<p>INPUT SPECIFICATIONS Namur: High Speed & Gate Input: Namur sensor DIN 19234 Reset Input: Potential free contact/NPN sensor Slow Speed Input: Potential free contact or NPN sensor DC: High Speed & Gate Input: NPN/PNP sensor Reset Input: Potential free contact/NPN sensor Slow Speed Input: Potential free contact or NPN sensor Max. Input frequency: High Speed Input: 5kHz Gate & Reset Input: 1kHz Slow Speed Input: 30Hz Minimum pulse width: High Speed Input: 100 microseconds Gate & Reset Input: 500 microseconds Slow Speed Input: 16.7microseconds Active pulse edge: High & slow Speed Input: Positive or negative, Namur and DC Gate Input: Low level on input SENSOR INTERFACE Replace* with sensor type 1= Namur negative edge 2= Namur positive edge 3= Negative - NPN/PNP(DC) 4= Positive - NPN/PNP(DC) Namur option: 8.2V DC/10mA DC (NPN or PNP) option: 12V DC/ 50mA Max. NPN saturation voltage: 2V DC (high speed count and gate inputs) 2.5V DC (low speed count input) Max. PNP sensor saturation voltage: 2V DC (high speed count and gate inputs) GENERAL SPECIFICATIONS Supply voltage: Replace ** with 24VAC/DC, 115VAC, 230VAC, 400VAC, 415VAC, 525VAC Protection class : IP 54 (front), IP30 (rear) Connection: Plug-connector</p>	<p>INPUT SPECIFICATIONS AC/DC: Supply voltage: 24V ±15% Isolation: No galvanic isolation Power consumption: 100mA Low speed input: Input type: potential-free contact or NPN sensor Maximum count frequency: 30Hz Minimum pulse width: 16.7ms High speed input: Maximum count frequency: 1kHz Minimum pulse width: 500Hz RESET INPUT Minimum pulse width: 500ms SENSOR INTERFACE Replace* with sensor type *D= PNP/NPN *N= Namur Namur: 8.2V DC/ 10mA DC (NPN/PNP): 12V DC/ 50mA Max. NPN sensor saturation voltage: 2VDC OUTPUT SPECIFICATIONS Solid state relay: 12V at 10mA GENERAL SPECIFICATIONS Supply voltage: Replace** with 12VDC, 24VAC/DC, 115VAC, 230VAC, 400VAC, 415VAC, 525VAC Maximum count frequency exceeded: 3 decimal points illuminating Power supply interruption < 1 second: 3 decimal points flashing Relay ON time: Adjustable range: 0.1 to 25 seconds Resolution: 0.1 second repeatable ±1% Set-up and data retention: ±10 years</p>	<p>INPUT SPECIFICATIONS High speed input: Namur: Namur sensor DIN 19234 DC: NPN or PNP sensor Maximum input frequency: 500Hz Minimum pulse width: 1 millisecond Active pulse edge: Positive or Negative Slow speed input: Namur & DC: Potential free contact or NPN sensor (open collector type) Maximum input frequency: 30 Hz Minimum pulse width: 16.7 ms Active pulse edge: Positive or Negative RESET INPUT: Namur & DC: Potential free contact or NPN sensor Maximum input frequency: 500Hz Minimum pulse width: 1 millisecond Active pulse edge: Negative: holds count value. Positive (if low for < 2 sec): resets count value and clears error messages SENSOR INTERFACE Replace* with Sensor Type *D= PNP/NPN *N= Namur Namur: 8.2V DC / 10mA NPN or PNP sensor: 12V DC/ 30mA Max.NPN sensor saturation voltage: 2V DC, 2.5V DC Maximum PNP sensor saturation voltage: 2V DC (high speed count input) OUTPUT SPECIFICATIONS Relay: 250 VAC, 8A, SPDT SSR Drive: 10mA at 6V GENERAL SPECIFICATIONS Supply voltage: Replace** with 12VAC, 12VDC, 24VAC, 24VDC, 48VAC, 115VAC, 230VAC, 400VAC</p>
Ordering Code Example	TYPE MODEL AC VOLTAGE OUTPUT VOLTAGE TYPE SC 900 / * — ** **	TYPE MODEL ACTIVE EDGE POWER SUPPLY CC 120 / * / **	TYPE MODEL VOLTAGE SENSOR TYPE RELAY CONTACTS SC 700 / ** / * SP	TYPE MODEL VOLTAGE SENSOR TYPE RELAY CONTACTS CC 701 / ** / * SP

PUMP MOTOR PROTECTION

Type	Motor System, Protection Relay Underload Reset Timer, Single Phase	Motor System, Protection Relay Variable Underload Monitor, Single Phase	Motor System, Protection Relay Underload Reset, Timer, Three Phase	Motor System, Protection Relay Variable Underload Monitor, Three Phase
				
Code	MP820	MP825	MP830	MP835
Features	<ul style="list-style-type: none"> Underload sensing by measuring the phase angle Adjustable restart time after detection of underload conditions Overload sensing by measuring the current amplitude Microprocessor-based technology Direct in-line current sensing of motors up to loads above 1.1kW Direct interface with a conventional current transformer Auto-calibration of overload/voltage and underload/voltage limits Liquid level control Latching on overload conditions Start-up delay (3 secs standard) Latching on overload conditions Fail-to-safe design Din-rail mount 5A SPDT relay output 	<ul style="list-style-type: none"> Underload sensing by measuring the phase angle Underload sensitivity adjustment after calibration of phase angle Overload sensing by measuring the current amplitude Microprocessor-based technology Direct in-line current sensing of motors up to 1.1kW Auto-calibration of overload/voltage and underload/voltage limits Direct interface with a conventional current transformer Liquid level control Start-up delay Latching on underload and overload conditions Fail-to-safe design Din-rail mount 5A SPDT relay output 	<ul style="list-style-type: none"> Underload sensing by measuring the phase angle Adjustable restart time after detection of underload conditions Overload sensing by measuring the current amplitude Microprocessor-based technology Direct in-line current sensing of motors up to 3.7kW Auto-calibration of overload/voltage and underload/voltage limits Direct interface with a conventional current transformer Phase sequence and phase failure detection Liquid level control Latching on overload conditions Fail-to-safe design Din-rail mount 5A SPDT relay output 	<ul style="list-style-type: none"> Underload sensing by measuring the phase angle Underload sensitivity adjustment after calibration of nominal phase angle Overload sensing by measuring the current amplitude Microprocessor-based technology Direct in-line current sensing of motors up to 3.7kW Auto-calibration of overload/voltage and underload/voltage limits Direct interface with a conventional current transformer Phase sequence and phase failure detection & Liquid level control Latching on underload and overload conditions Fail-to-safe design Din-rail mount 5A SPDT relay output
Connection Diagram				
Specifications	<p>POWER SUPPLY Supply Voltage: 230VAC Supply Voltage Tolerance: AC, 176 - 288V AC Power Consumption: 4VA (approx) Isolation (current input to power supply): 2kV Supply frequency: 50/60Hz</p> <p>RESPONSE Start-up Delay: 3 seconds fixed, standard (extended times available on request) Response Delay: Overload 3 seconds. On all other faults 1 second</p> <p>RESTART Restart Timer (underload): 15 min - 24 hrs (adjustable) Reset lockout: Max. 3 resets per 15mins</p> <p>CURRENT INPUT Motors <1.1kW: Current limits to ensure calibration: 0,5 to 10A Repetitive accuracy: 1% Maximum input current (continuous): 15A</p> <p>Motors >1.1kW: (use external CT) Motor: 1.5kW, 2.2kW Current Transformer: 20/5, 30/5</p> <p>CALIBRATION Phase Angle Limits: Underload: 90° or 125% of calibration value Current Limits: Overload: 13A or 125% of calibration value Voltage Limits: ±10% of calibration value RELAY: 250V, 5A SPDT LEVEL CONTROL: Sensitivity: 50 kΩ</p>	<p>POWER SUPPLY Supply Voltage: 230VAC Supply Voltage Tolerance: AC, 176 - 288V AC Power Consumption: 4VA (approx) Isolation (current input to power supply): 2kV Supply frequency: 50/60Hz</p> <p>RESPONSE Start-up Delay: 3 seconds fixed, standard (extended times available on request) Response Delay: Overload 3 sec</p> <p>RELAY: 250V, 5A SPDT RESTART: Reset lockout: Max 3 resets per 15mins</p> <p>CURRENT INPUT Motors <1.1kW: Current limits to ensure calibration: 0,5 to 10A Repetitive accuracy: 1% Maximum input current (continuous): 15A</p> <p>Motors >1.1kW: (use external CT) Motor: 1.5kW, 2.2kW Current Transformer: 20/5, 30/5</p> <p>CALIBRATION Phase Angle Limits: Underload: 90° or 120 - 160% of calibration value (underload) Current Limits: Overload: 13A or 125% of calibration value Voltage Limits: ±10% of calibration value LEVEL CONTROL Sensitivity: 50 kΩ</p>	<p>POWER SUPPLY Supply Voltage: 230/400/525VAC Supply Voltage Tolerance: 176 - 288V AC, 304 - 498VAC, 420 - 630V AC Power Consumption: 4VA (approx) Isolation (current input to power supply): 2kV Supply frequency: 50/60Hz</p> <p>RESPONSE Start-up Delay: 3 seconds fixed, standard (extended times available on request) Response Delay: Overload 3 seconds Phase sequence/ failure instantaneous on all other faults 1 second</p> <p>RESTART: Restart Timer (underload): 15 min - 24 hrs (adjustable). Reset lockout: Max. 3 resets per 15mins</p> <p>RELAY: 250V, 5A SPDT</p> <p>CALIBRATION Phase Angle Limits: Underload: 90° or 125% of calibration value Current Limits: Overload: 10A or 125% of calibration value. Voltage Limits: ±10% of calibration value CURRENT INPUT Motors <3.7kW: Current limits to ensure calibration: 0,5 to 8A. Repetitive accuracy: 1% Maximum input current (continuous): 12A LEVEL CONTROL Sensitivity: 50 kΩ</p>	<p>POWER SUPPLY Supply Voltage: 230/400/525VAC Supply Voltage Tolerance: 176 - 288V AC, 304 - 498VAC, 420 - 630V AC Power Consumption: 4VA (approx) Isolation (current input to power supply): 2kV Supply frequency: 50/60Hz</p> <p>RESPONSE Start-up Delay: 3 seconds fixed, standard (extended times available on request) Response Delay: Overload 3 seconds Phase sequence/ failure instantaneous on all other faults 1 second</p> <p>RESTART Reset lockout: Max. 3 resets per 15 minutes</p> <p>RELAY 250V, 5A SPDT</p> <p>CURRENT INPUT Motors <3.7kW: Current limits to ensure calibration: 0,5 to 8A Repetitive accuracy: 1% Maximum input current (continuous): 12A CALIBRATION Phase Angle Limits: Underload: 90° or 120 - 160% of calibration value Current Limits: Overload: 10A or 125% of calibration value Voltage Limits: ±10% of calibration value LEVEL CONTROL Sensitivity: 50kΩ</p>
Ordering Code Example	TYPE MODEL VOLTAGE POWER SUPPLY RELAY CONTACTS MP 820 / 230V AC SP	TYPE MODEL VOLTAGE POWER SUPPLY RELAY CONTACTS MP 825 / 230V AC SP	TYPE MODEL VOLTAGE POWER SUPPLY RELAY CONTACTS MP 830 / AC SP	TYPE MODEL VOLTAGE POWER SUPPLY RELAY CONTACTS MP 835 / AC SP

DIN RAIL MOUNT TIMERS

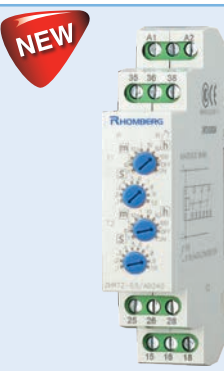



Type	Delay on Timer	Multifunction Timer	Star Delta Timer	Passage Light Timer	Unequal Cycling Timer
(Replace * with relay type.) (Replace * with supply voltage.)					
Code	ZHRT1-A - */*	ZHRT1-M - */*	ZHRT1-ST/*	ZHRT1-LS/*	ZHRT1-S2-/*
Output	Replace * in Code with *2 = 2 x Timed C/O *2T = 1 x Timed + 1 x Instantaneous C/O 5A@250VAC	Replace * in Code with *2 = 2 x Timed C/O *2T = 1 x Timed + 1 x Instantaneous C/O 5A@250VAC	2 x NO 5A@250VAC	1 x NO 5A@250VAC	2 x C/O 5A@250VAC
Function	<ul style="list-style-type: none"> • Microprocessor based • LED indication of supply and relay state • On application of power the time function starts. At the end of time delay the relay operates • The unit is reset by removal and re-application of power supply • Wide time range of 0.1s to 100Hr 	<ul style="list-style-type: none"> • Microprocessor based • LED indication of supply and relay state • 10 Independent operating functions: <ul style="list-style-type: none"> A - Delay on operate B - Delay on Release C - Cycle timer OFF first D - Cycle timer ON first E - Interval hold reset F - Interval pulse reset G - Delay OFF hold reset H - Delay ON/OFF pulse reset I - Latching pulse reset J - Pulse Generator • Wide time range of 0.1s to 100Hr 	<ul style="list-style-type: none"> • Microprocessor based • LED indication of supply and relay state. • Start time adjustable 1s - 10min. • Pause time adjustable 20ms - 300ms. • The unit is reset by removal and re-application of power supply 	<ul style="list-style-type: none"> • Microprocessor based • Control of stairwell or Passage Lighting • When the unit receives a pulse input (L/N) the relay operates for the preset time. At the end of the set time it switches off automatically. • LED indication of supply and relay state • Auto or Manual Mode • Time Range adjustable: 30s - 20min 	<ul style="list-style-type: none"> • Microprocessor based • LED indication of supply and relay state • Time ranges from 0.1s to 100Hr • Timing Functions start on application of power supply. • The unit is reset by removal and re-application of power supply.
Supply Voltage	*D12 = DC12V *AD240 = AC/DC 24-240V *A400 = AC400	*D12 = DC12V *AD240 = AC/DC 24-240V *A400 = AC400	*A110 = AC110V *A230 = AC230V *A400 = AC400V	*A110 = AC110V *A230 = AC230V *A400 = AC400V	*AD240 = AC/DC 24-240V *A110 = AC110V *A400 = AC400V

Type	No Power Delay Off	Delay On Restart Timer	Unequal Cycling Timer	Intermediate Relay
<div style="display: flex; justify-content: space-around;"> <div style="text-align: center;">  </div> <div style="text-align: center;">  </div> <div style="text-align: center;">  </div> <div style="text-align: center;">  </div> </div>	ZHRT1-D/*	ZHRT1-SD/*	ZHRT2-S3T/*	ZHRT2-R3/*
Output	1 x C/O 5A@250VAC	1 x C/O 5A@250VAC	2 x timed C/O 16A@250VAC 1 x Instantaneous 16A@250VAC	3 x C/O 8A@250VAC
Function	<ul style="list-style-type: none"> • Microprocessor based • Relay operates when power is applied. • Timing starts when power is removed. • Power must be present for ≥ 2000ms • Delay time range 0.1s-10m • LED indication of status 	<ul style="list-style-type: none"> • Microprocessor based • Relay operates when power is applied. • Relay de-energises when power fails • When power is restored the re-start time function begins • When re-start time period expires the relay re-energises • Delay time range 0.5-20m • LED indication of status 	<ul style="list-style-type: none"> • Microprocessor based • Instantaneous relay contact energises and time period starts. • Timed relays energises at end of pre set time period • Unit reset by removal and re-application of power • Delay time range 0.1s-100hr • LED indication of status 	<ul style="list-style-type: none"> • Used to expand the number of relay contacts • Operates similar to 11 pin plug-in industrial relay but in DIN rail mount format
Supply Voltage	*D12 = DC12V, *A115 = AC115V *A230 = AC230V *A400 = AC400V	*A115 = AC115V *A230 = AC230V	*D12 = DC12V, *AD240 = 24-240VAC/DC	*D12 = DC12V, *AD240 = 24-240VAC/DC

VOLTAGE MONITORS

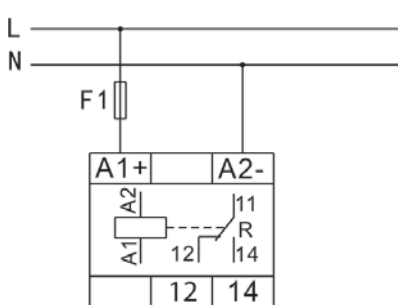
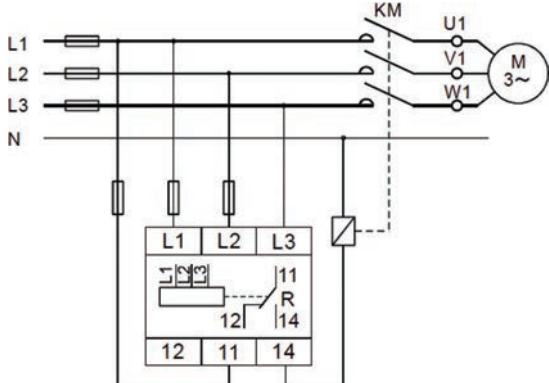

Type	Single phase Over / Under Voltage Protector (Fixed TripPoints)	Single phase Over / Under Voltage Protector	3 Phase Over / Under Voltage, Phase Sequence / Failure /Asymmetry Neutral Fail, Timed Fail / Reset	3 Phase Phase Failure/ Sequence/ Asymmetry	3 Phase Over/Under Voltage, Phase Sequence/ Failure/Symmetry
(Replace * with supply voltage.)					
	Code	ZHRV2-36G/*	ZHRV2-54T/*	ZHRV2-S/*	ZHRV3-01-Z/ *
Output	1 x N/O	1 x N/O	1 x C/O 10A/250VAC	2 x C/O 5A@250VAC	2 x C/O 5A@250VAC
Function	<p>O/Voltage Trip 265VAC Recover at 257VAC U/Voltage Trip 175VAC Recover at 180VAC Power-On delay 2s Trip delay 0,1s Reset delay 1s Auto reset</p> <p>Switching capacity * Add to code 32 = 32A@250VAC 40 = 40A@250VAC 63 = 63A@250VAC 80 = 80A@250VAC</p> <p>Not Suitable for Refridgeration Applications</p>	<p>Overvoltage Trip 210-280VAC Recover at trip x 97% Undervoltage Trip 120-200VAC Recover at trip x 103% Power-On delay 2s Trip delay 5 - 600s Reset delay 1s</p> <p>• Auto reset • Display voltage</p> <p>Switching capacity * Add to code 40 = 40A@250VAC 63 = 63A@250VAC 80 = 80A@250VAC</p>	<p>Overvoltage 5% - 20% Under voltage 5% - 20% Phase Sequence / Failure Neutral Failure 1volt Over / Under increments Asymmetry trip 0.1 - 20s Phase Sequence trip ≤ 0.2s Phase failure trip ≤ 0.2s</p> <p>• Protection can be turned On/Off • Display phase voltages (P-N) • Microprocessor based • True RMS measurement • LCD status Indication</p>	<p>Phase Sequence/Failure Asymmetry 5-15% Trip Delay 0.1-10s Reset Time 0.1-10s</p> <p>• Microprocessor based • True RMS measurement • 8 Nominal voltage operating ranges • LED status indication • Trip/Reset delay adjustable • Suitable for either 3 or 4-Wire systems</p>	<p>Phase Sequence/Failure Overvoltage 2-20% Undervoltage 2-20% Asymmetry 5-15% Trip Delay 0.1-10s Reset Time 0.1-10s</p> <p>• Microprocessor based • True RMS measurement • 8 Nominal voltage operating ranges • LED status indication • Trip/Reset delay adjustable • Suitable for either 3 or 4-Wire systems</p>
Supply	AC 230V	AC 230V	<p>*M240 = AC 220V - 440V *M415 = AC 380V - 415V Frequency Range 45 - 65Hz</p>	<p>*M440 = AC 208V-440 (8 Set Points-P/P) *M254 = AC 120V-254V (8 Set Points-P/N) Frequency Range: 45 - 65Hz</p>	<p>*M440 = AC 208V-440 (8 Set Points-P/P) *M254 = AC 120V- 254V (8 Set Points-P/N) Frequency Range: 45 - 65Hz</p>
Connection Diagram					

VOLTAGE MONITORS

Type	Over or Under Voltage Monitor	Over and Under Voltage Monitor (Comparator)	3 Phase Over/Under Voltage, Phase Sequence/Failure/Asymmetry	3 Phase Phase Sequence/Failure/Asymmetry
(Replace * with supply voltage.)				
Code	ZHRV5-01/ *	ZHRV5-02/ *	ZHRV5-09/ *	ZHRV5-11/ *
Output	1 x C/O 5A@250VAC	1 x C/O 5A@250VAC	1 x C/O 5A@250VAC	1 x C/O 5A@250VAC
Function	Selectable Operating Modes: - Over Voltage Latching - Over Voltage Non-Latching - Under Voltage Latching - Under Voltage Non-Latching • Voltage threshold adjustable (Dependant on Supply Voltage) • Hysteresis: 5-20% • Time Delay: 0.1-10s • Microprocessor based • True RMS measurement • Monitor AC or DC. • LED indication of control state.	Over & Under Voltage Levels adjustable (Dependant on supply voltage). Fixed Hysteresis: 5% Time Delay: 0.1-10s • Microprocessor based • True RMS measurement • Monitor AC or DC • LED indication of control state.	Phase Sequence/Failure Overvoltage 2-20% Undervoltage 2-20% Asymmetry fixed 8% Trip Delay 0.1-10s • Microprocessor based • True RMS measurement • 8 Nominal voltage Operating Ranges • LED status indication.	Phase Sequence/Failure Asymmetry 8% Trip Delay 2s • Microprocessor based • True RMS measurement • 8 Nominal voltage Operating Ranges • Frequency Range: 45-65Hz • LED status indication
Supply	*D12 = DC 12V *AD48 = AC/DC 24-48V *AD240 = AC/DC 110-240V	*D12 = DC 12V *AD48 = AC/DC 24-48V *AD240 = AC/DC 110 - 240V	*M460 = AC 220V-440V (8 Set Points-P/P) Frequency Range: 45 - 65Hz	*M460 = AC 220V - 440V (8 Set Points-P/P) Frequency Range 45 - 65Hz
Connection Diagram				

NEW

MOTOR PROTECTION RELAYS

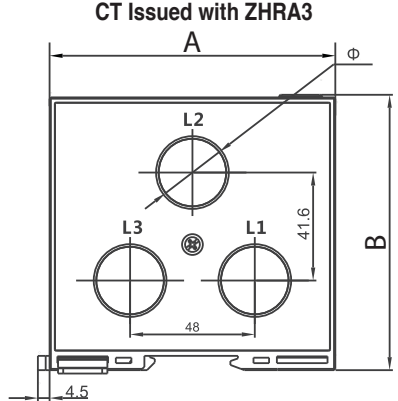
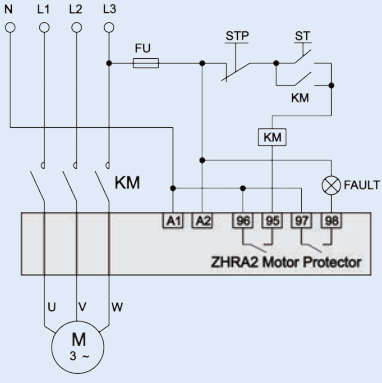
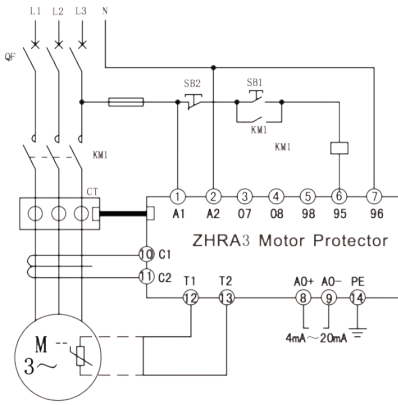
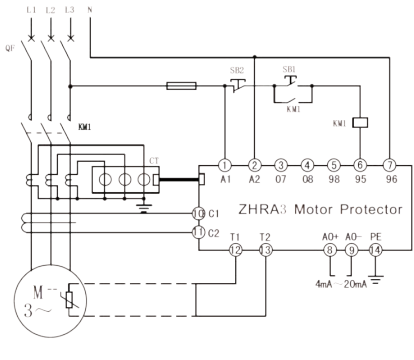
Type	Motor Protection Relay	Motor Protection with Remote CT																																				
																																						
																																						
Code	ZHRA2-*/**-S	ZHRA3-*.**-***																																				
Output	1 x N/C 5A@250VAC 1 x N/O 5A@250VAC	1 x C/O 5A@250VAC 1 x Aux N/O 5A@250VAC																																				
Function	No load start, Overload, Phase Failure, Stall, Asymmetry Protection. <ul style="list-style-type: none"> • Microprocessor based design • Digital display (current values) 	Overload, Phase Failure, Stall, Grounding, Temperature, Asymmetry, Neutral Failure <ul style="list-style-type: none"> • Microprocessor based design • LCD backlit display shows Current, and Fault status • Star-Delta and Auto Buck starts *** Optional O/P Add to code 4/20 (4 - 20mA) RS (RS485 Modbus)																																				
	<table border="1"> <thead> <tr> <th>* Add to Code</th> <th>Trip Current</th> <th>Motor kW</th> </tr> </thead> <tbody> <tr> <td>6</td> <td>0.5 - 6A</td> <td>0.25 - 3kW</td> </tr> <tr> <td>60</td> <td>5 - 60A</td> <td>3 - 30kW</td> </tr> <tr> <td>240</td> <td>20 - 240A</td> <td>11 - 110kW</td> </tr> <tr> <td>—</td> <td>—</td> <td>—</td> </tr> <tr> <td>—</td> <td>—</td> <td>—</td> </tr> </tbody> </table>	* Add to Code	Trip Current	Motor kW	6	0.5 - 6A	0.25 - 3kW	60	5 - 60A	3 - 30kW	240	20 - 240A	11 - 110kW	—	—	—	—	—	—	<table border="1"> <thead> <tr> <th>* Add to Code</th> <th>Trip Current</th> <th>Motor kW</th> </tr> </thead> <tbody> <tr> <td>5</td> <td>1-5A</td> <td>0.55 - 2.2kW</td> </tr> <tr> <td>10</td> <td>2-10A</td> <td>1.1 - 4kW</td> </tr> <tr> <td>30</td> <td>6-30A</td> <td>3 - 15kW</td> </tr> <tr> <td>50</td> <td>10-50A</td> <td>5.5 - 22kW</td> </tr> <tr> <td>200</td> <td>40-200A</td> <td>22 - 90kW</td> </tr> </tbody> </table>	* Add to Code	Trip Current	Motor kW	5	1-5A	0.55 - 2.2kW	10	2-10A	1.1 - 4kW	30	6-30A	3 - 15kW	50	10-50A	5.5 - 22kW	200	40-200A	22 - 90kW
* Add to Code	Trip Current	Motor kW																																				
6	0.5 - 6A	0.25 - 3kW																																				
60	5 - 60A	3 - 30kW																																				
240	20 - 240A	11 - 110kW																																				
—	—	—																																				
—	—	—																																				
* Add to Code	Trip Current	Motor kW																																				
5	1-5A	0.55 - 2.2kW																																				
10	2-10A	1.1 - 4kW																																				
30	6-30A	3 - 15kW																																				
50	10-50A	5.5 - 22kW																																				
200	40-200A	22 - 90kW																																				
Supply Voltage	**A230 for 230VAC **A400 for 400VAC Frequency Range 45 - 65Hz	**A230 for 230VAC **A400 for 400VAC Frequency Range 45 - 65Hz																																				
Connection Diagram	 <p>Direct start with 230VAC contactor. For other configurations see product data sheet</p>	 <p>Direct start with 230VAC contactor. For other configurations see product data sheet</p>																																				
		 <p>Secondary start with 230VAC contactor. For other configurations see product data sheet</p>																																				
		<table border="1"> <thead> <tr> <th>Size</th> <th>1-50A</th> <th>40-200A</th> </tr> </thead> <tbody> <tr> <td>A</td> <td>88mm</td> <td>110mm</td> </tr> <tr> <td>B</td> <td>80mm</td> <td>106mm</td> </tr> <tr> <td>C</td> <td>62.5mm</td> <td>84.5mm</td> </tr> <tr> <td>Ø</td> <td>16mm</td> <td>26mm</td> </tr> </tbody> </table>	Size	1-50A	40-200A	A	88mm	110mm	B	80mm	106mm	C	62.5mm	84.5mm	Ø	16mm	26mm																					
Size	1-50A	40-200A																																				
A	88mm	110mm																																				
B	80mm	106mm																																				
C	62.5mm	84.5mm																																				
Ø	16mm	26mm																																				





NEW

MOTOR PROTECTION RELAYS







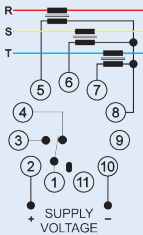
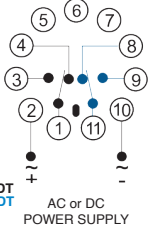
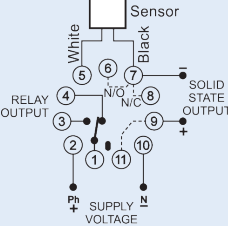
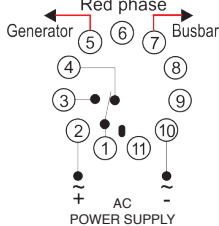
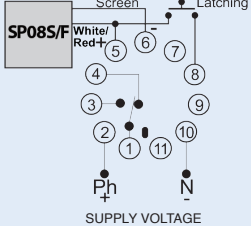
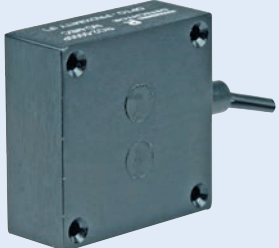







LIQUID LEVEL CONTROLLER

Type	Motor Protector		Type	Liquid Level Control															
<p>(Replace * with trip current)</p> <p>(Replace * with supply voltage)</p>			<p>(Replace * with supply voltage)</p>																
Code	ZHRA1-*/*	ZHRA5*	Code	ZHRL1-A/*															
Output	1 x C/O 5A@230VAC	1 x N/C 1A@240VAC	Output	1 x C/O 250VAC@1.5A															
Function	<p>Inverse time current protection, overload, phase failure, phase asymmetry and locked rotor protection.</p> <p>LED Indication of status</p> <p>Current transformers integrated into the body of the unit.</p> <p>Various Current Ranges available:</p> <table border="1"> <thead> <tr> <th>Trip Current</th> <th>Motor Kw</th> </tr> </thead> <tbody> <tr> <td>*1A-5A</td> <td>0.5 - 2.5kW</td> </tr> <tr> <td>*6A-30A</td> <td>3 - 15kW</td> </tr> <tr> <td>*16A-80A</td> <td>8 - 40kW</td> </tr> <tr> <td>*80A-400A</td> <td>40 - 200kW</td> </tr> </tbody> </table> <p>Current adjustable within range. Adjustable start Delay: 2-30s</p>	Trip Current	Motor Kw	*1A-5A	0.5 - 2.5kW	*6A-30A	3 - 15kW	*16A-80A	8 - 40kW	*80A-400A	40 - 200kW	<p>Does not require power supply. Simplified wiring & installation.</p> <p>Overload, Phase Failure Protection</p> <p>Thyristor Output.</p> <p>LED Indication of status.</p> <p>Compact design. Low Cost.</p> <p>Current transformers integrated into the body of the unit.</p> <p>Various Current Ranges available:</p> <table border="1"> <thead> <tr> <th>Trip Current</th> </tr> </thead> <tbody> <tr> <td>*0.5A - 5A</td> </tr> <tr> <td>*2A - 20A</td> </tr> <tr> <td>*20A - 80A</td> </tr> <tr> <td>*64A - 160A</td> </tr> </tbody> </table>	Trip Current	*0.5A - 5A	*2A - 20A	*20A - 80A	*64A - 160A	Function	<p>Charge and Discharge. (Fill & Drain)</p> <p>Adjustable Sensitivity: 5kΩ - 100kΩ.</p> <p>Can operate as 2 or 3 probe system</p> <p>Adjustable delay to prevent false triggers: 0.1-10s</p> <p>LED indication of high/low water level</p>
	Trip Current	Motor Kw																	
*1A-5A	0.5 - 2.5kW																		
*6A-30A	3 - 15kW																		
*16A-80A	8 - 40kW																		
*80A-400A	40 - 200kW																		
Trip Current																			
*0.5A - 5A																			
*2A - 20A																			
*20A - 80A																			
*64A - 160A																			
Supply Voltage	<p>*AC230V</p> <p>*AC400V</p> <p>Frequency Range 45 - 65Hz</p>	No power supply required	Supply Voltage	<p>*A110 = AC 110V</p> <p>*A230 = AC 230V</p>															
Connection Diagram	<p>Direct Start with AC230V contactor. For other configurations see product data sheet.</p>		Connection Diagram																

SPECIAL PRODUCTS

Type	3-Phase Current Monitor	Re-cycling Timer with Pause	Control Module for Namur Sensors	Semi-Automatic Synchronising Unit	Spark Detector																																
																																					
Code	CM193	DT310/12	PSM1130/3	SAS110	SP08M																																
Features	<ul style="list-style-type: none"> Ready to operate when the current transformers and shunt resistor block-SR3 is connected When power is applied the relay energises immediately LED indication showing power ON If the current on any of the 3 phases fails below the set limit for at least one second, the relay will de-energise and the LED extinguishes 	<ul style="list-style-type: none"> Unit starts with pause mode Contacts totally isolated Adjustable pause time ranges Adjustable cycle time ranges Whole cycle will continuously repeat until power has been switch off 	<ul style="list-style-type: none"> Transistorised switching amplifier for inductive proximity sensors to DIN19234 (Namur) Available as a solid state or relay output Selectable delay on output Programmable for metal sensing and non metal sensing LED indication for metal sensed or no metal sensed LED indication when relay is energised 	<ul style="list-style-type: none"> Senses differences in voltage, frequency and phase angle between the generator and the busbar system LED illuminates when all 3 parameters match Hysteresis setting for voltage Response delay 0,3 to 3 secs Adjustable voltage synchronisation point, 5-30V RMS 	<ul style="list-style-type: none"> Detects infra light from arcing or flames Long dist. sensing and acc. location Cost effective solutions, detection in burners, boilers or fire detection equip. In conjunction with a suitable infra light source, a high speed opto-barrier syst. Syst. consists of a Control Unit SP-08M & side or front sensor heads SP-08S/F Initiates power shut down before permanent damage is done The sensor heads can be connected in parallel and any sensor will trigger the relay output The module can be configured to latch when arcing is sensed 																																
Connection Diagram																																					
Specifications	<p>POWER SUPPLY **AC: Supply voltage: 115, 230, 400, 415, 525V ±15% Power consumption: 3VA (approx), 6VA for 415, 525V (approx) Isolation: no galvanic isolation Shunt resistor block - SR3 - *1Amp or 5Amp</p> <p>GENERAL Weight: 190g Colour: Blue</p>	<p>POWER SUPPLY AC: Supply voltage: 48, 60, 115, 230, 400, 415, 525V ±15% Power consumption: 3VA (approx), 6VA for 415, 525V (approx) DC: 24V only.</p> <p>GENERAL Weight: 190g Colour: Blue</p> <table border="1"> <thead> <tr> <th colspan="2">PAUSE TIME RANGES</th> </tr> </thead> <tbody> <tr> <td>0,1 - 2 sec</td> <td>1 - 20 min</td> </tr> <tr> <td>0,3 - 6 sec</td> <td>3 - 60 min</td> </tr> <tr> <td>1 - 20 sec</td> <td>10 - 200min</td> </tr> <tr> <td>3 - 60 sec</td> <td>0,5 - 10 hrs</td> </tr> <tr> <td>10 - 200 sec</td> <td>1 - 20 hrs</td> </tr> <tr> <td>30 - 600 sec</td> <td>1 - 30 hrs</td> </tr> </tbody> </table> <table border="1"> <thead> <tr> <th colspan="2">CYCLE TIME RANGES</th> </tr> </thead> <tbody> <tr> <td>0,1 - 2 sec</td> <td>1 - 20 min</td> </tr> <tr> <td>0,3 - 6 sec</td> <td>3 - 60 min</td> </tr> <tr> <td>1 - 20 sec</td> <td>10 - 200min</td> </tr> <tr> <td>3 - 60 sec</td> <td>0,5 - 10 hrs</td> </tr> <tr> <td>10 - 200 sec</td> <td>1 - 20 hrs</td> </tr> <tr> <td>30 - 600 sec</td> <td>1 - 30 hrs</td> </tr> </tbody> </table> <p>*Relay contact SP= Single Pole DP= Double Pole</p>	PAUSE TIME RANGES		0,1 - 2 sec	1 - 20 min	0,3 - 6 sec	3 - 60 min	1 - 20 sec	10 - 200min	3 - 60 sec	0,5 - 10 hrs	10 - 200 sec	1 - 20 hrs	30 - 600 sec	1 - 30 hrs	CYCLE TIME RANGES		0,1 - 2 sec	1 - 20 min	0,3 - 6 sec	3 - 60 min	1 - 20 sec	10 - 200min	3 - 60 sec	0,5 - 10 hrs	10 - 200 sec	1 - 20 hrs	30 - 600 sec	1 - 30 hrs	<p>POWER SUPPLY AC Transformer: Supply Voltage: 12, 24, 48, 60,115, 230V ±15% Operating frequency: 40-60 Hz Isolation test voltage: 2KV Power Consumption: 2,5VA Overvoltage protection: 50% for 1 min(50Hz) DC: Supply Voltage: 24V, ±15% Max. ripple: 100% (above 50Hz) Power Consumption: approx. 1,5W Overvoltage protection:100% for 1 min. on 24VDC Rating for continuous op.:100% ED Voltage stabilisation: Yes Transient protection: Yes Operating temp.: -20 to +50°C Supply interruptions: Will not react to interruptions less than 30ms</p> <p>TIMERS: Input pulse length: 0,1 to 5 secs Output hold time: 0,1 to 5 secs Repeatability: approx. 1% Overall accuracy: approx. 5%</p> <p>OUTPUT Relay contact: 1x single pole change over contact Contact rating (resistive load): 380VAC - 10A - 2500VA Contact isolation:2500V</p> <p>SOLID STATE Type: Open collector transistor Output sink current: 100mA/12VDC</p> <p>GENERAL Weight: 190g Colour: Blue</p>	<p>POWER SUPPLY AC: Supply voltage:115, 230, 400, 415, 525V ±15% Power consumption: 3VA, 6VA for 415, 525V (approx) Over voltage protection: 50% for 1 minute</p> <p>Red Phase: Over voltage protection: 750V</p> <p>GENERAL Weight: 200g Colour: Blue</p>	<p>POWER SUPPLY AC: Supply Voltage: 12, 24, 115, 230, 400V Power Consumption: 3VA(approx) Isolation: 2kV (voltage input to power supply)Tolerance: ±15%</p> <p>GENERAL Weight: 190g Colour: Blue</p> <p>Sensor Head - to be ordered separately</p>  <table border="1"> <thead> <tr> <th>SP08F</th> <th>SP08S</th> </tr> </thead> <tbody> <tr> <td>Front sensing</td> <td>Side sensing</td> </tr> </tbody> </table>	SP08F	SP08S	Front sensing	Side sensing
PAUSE TIME RANGES																																					
0,1 - 2 sec	1 - 20 min																																				
0,3 - 6 sec	3 - 60 min																																				
1 - 20 sec	10 - 200min																																				
3 - 60 sec	0,5 - 10 hrs																																				
10 - 200 sec	1 - 20 hrs																																				
30 - 600 sec	1 - 30 hrs																																				
CYCLE TIME RANGES																																					
0,1 - 2 sec	1 - 20 min																																				
0,3 - 6 sec	3 - 60 min																																				
1 - 20 sec	10 - 200min																																				
3 - 60 sec	0,5 - 10 hrs																																				
10 - 200 sec	1 - 20 hrs																																				
30 - 600 sec	1 - 30 hrs																																				
SP08F	SP08S																																				
Front sensing	Side sensing																																				
Ordering Code Example	TYPE MODEL SHUNT VOLTAGE POWER RELAY CON. SUPPLY TACTS CM 193 / * / ** AC SP	TYPE MODEL VOLTAGE POWER RELAY CON. SUPPLY TACTS DT 310 / 230V AC *	TYPE MODEL VOLTAGE RELAY CONTACTS PSM 1130/3 / 230V SP	TYPE MODEL VOLTAGE POWER SUPPLY SAS 110 / 230V AC	TYPE MODEL VOLTAGE POWER SUPPLY SP 08M / 230V AC																																

DIGITAL PANEL METERS

	AC Voltage Meter	AC Ampere Meter	DC Voltage Meter	DC Ampere Meter	Frequency Meter
Size: 48 x 48mm Cutout: 45 x 45mm					
Code	DHC8P-VAC	DHC8P-AAC	DHC8P-VDC*	DHC8P-ADC*	DHC8P-HZ
Display	999 (3 digit) 0.56 inch LED	999 (3 digit) 0.56 inch LED	999 (3 digit) 0.56 inch LED	999 (3 digit) 0.56 inch LED	3 digit 0.56 inch LED
Power Supply	100-240VAC/ DC	100-240VAC/ DC	100-240VAC/ DC or 12 - 60VDC	100-240VAC/ DC or 12 - 60VDC (Shunt 60mV)	100-240VAC/ DC
Input	Direct: 600V, 99.9V, 9.99V, Selectable	CT(5A), 5A, 10A, 15A, 20A, 30A, 40A, 50A, 60A, 70A, 80A, 90A, 100A, 200A, 300A, 400A, 500A, 600A, 700A, 800A, 900A, 999A, Selectable	Direct: 600V, 99.9V, 9.99V selectable	*Shunt (50mV, 60mV, 150mV): 5A, 10A, 15A, 20A, 30A, 40A, 50A, 60A, 70A, 80A, 90A, 100A, 150A, 200A, 300A, 400A, 500A, 600A, 700A, 800A, 900A, 999A, Selectable	0.2-400Hz
Accuracy	≤0.5% ± 1 digit (at 25°C)	≤0.5% ± 1 digit (at 25°C)	≤0.5% ± 1 digit (at 25°C)	≤0.5% ± 1 digit (at 25°C)	≤0.2% ± 1 digit (at 25°C)
	AC Voltage Meter	AC Ampere Meter	DC Voltage Meter	DC Ampere Meter	Frequency Meter
Size: 72 x 72mm Cutout: 68 x 60mm					
Code	DHC7P-VAC	DHC7P-AAC	DHC7P-VDC	DHC7P-ADC*	DHC7P-HZ
Display	1999 (3½ digit) 0.8 inch LED	1999 (3½ digit) 0.8 inch LED	1999 (3½ digit) 0.8 inch LED	1999 (3½ digit) 0.8 inch LED	3 digit 0.8 inch LED
Power Supply	AC/DC: 100~240V≤4VA	AC/DC: 100~240V≤4VA	100-240VAC/ DC or 12 - 60VDC	100-240VAC/ DC or 12 - 60VDC (Shunt 60mV)	AC/DC: 100~240V≤4VA
Input	Direct: 600V, 199.9V, 19.9V, 1.999V, Selectable	Direct: 5A CT(5A), 10A, 15A, 20A, 50A, 100A, 150A, 200A, 500A, 1000A, 1500A, 1999A, Selectable	Direct: 600V, 199.9V, 19.99V, 1.999V, Selectable	*Shunt (50mV, 60mV, 150mV): 5A, 10A, 15A, 20A, 50A, 100A, 150A, 200A, 500A, 1000A, 1500A, 1999A, Selectable	0.2-400Hz
Accuracy	≤0.5% ± 1 digit (at 25°C)	≤0.5% ± 1 digit (at 25°C)	≤0.5% ± 1 digit (at 25°C)	≤0.5% ± 1 digit (at 25°C)	≤0.2% ± 1 digit (at 25°C)
	AC Voltage Meter	AC Ampere Meter	DC Voltage Meter	DC Ampere Meter	Frequency Meter
Size: 48 x 96mm Cutout: 45 x 92mm					
Code	DHC3P-VAC	DHC3P-AAC	DHC3P-VDC	DHC3P-ADC*	DHC3P-HZ
Display Digit	1999 (3½ digit) 0.56" LED	1999 (3½ digit) 0.56" LED	1999 (3½ digit) 0.56" LED	1999 (3½ digit) 0.56" LED	3 digit 0.56" LED
Power Supply	AC/DC: 100~240V≤4VA	AC/DC: 100~240V≤4VA	100-240VAC/ DC	100-240VAC/ DC	AC/DC: 100~240V≤4VA
Input	Direct: 600V, 199.9V, 19.99V, 1.999V, Selectable	Direct (5A) CT(5A): 5A, 10A, 15A, 20A, 30A, 40A, 50A, 60A, 70A, 80A, 90A, 100A, 150A, 200A, 300A, 400A, 500A, 600A, 700A, 800A, 900A, 1000A, 1500A, 1999A selectable	Direct: 600V, 199.9V, 19.99V, 1.999V, Selectable	*Shunt (50mV): 5A, 10A, 15A, 20A, 50A, 100A, 150A, 200A, 500A, 1000A, 1500A, 1999A, Selectable	0.2-400Hz
Accuracy	≤0.5% ± 1 digit (at 25°C)	≤0.5% ± 1 digit (at 25°C)	≤0.5% ± 1 digit (at 25°C)	≤0.5% ± 1 digit (at 25°C)	≤0.1% ± 1 digit (at 25°C)

DIGITAL PROCESS METERS



DPM

Programmable DC Ammeter or Process Meter

- Size 48 x 96mm
- Accuracy CL 0.5
- Decimal point & range adjustable

Code	Description
DHC3P-SVA1	<ul style="list-style-type: none"> • Input: 4-20mA, 0-20mA, 0-1V, 0-5V, 1-5V, 0-10V, 0-200mV • Supply: 110-240VAC/DC 2.5VA • Output: 0-12-24VDC
DHC3P-SVA2	<ul style="list-style-type: none"> • As DHC3P-SVA1 with 4-20mA Re-transmission output
DHC3P-SVA3	<ul style="list-style-type: none"> • As DHC3P-SVA1 with high & low relay alarm output. N/O.

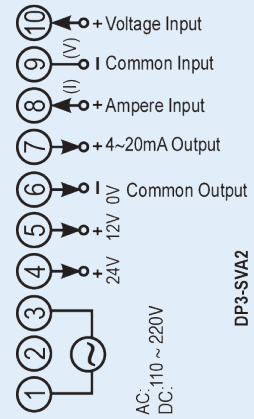

DIGITAL TIMERS & COUNTERS

Type	Timer	Timer/ Counter	Pre-Set Counter	Up / Down Totalizing Counter	Total Counter Hour Meter
DPM					
	6 Timing Functions	Auto or Manual Reset	Auto or Manual Reset	Manual or Electronic Reset	
Code	DHC48	DHC10J	DHC5J	DHC9J-J	DHC15J
Size(mm)	48 x 48 x 92	48 x 48	48 x 48 x 92	36 x 72 x 77	2 Module DIN mount
Panel Cutout	45 x 45	45 x 45	45 x 45	33 x 68.5	
Range	Delay ON/ Interval/ Equal Repeating. 0.01s-99h59m	Timer: 0.01s-99h59m Counter: 0-9999	0-9999	0-9999	0-99999999
Counting Speed	-	30/500cps	30/1000cps	30/1000cps	10cps
Display	0.3 inch LED (4 digit)	2 line 4 digit LED	0.3 inch LED (4 digit)	0.56 inch LED (6 digit)	8 digit LCD display
Power Supply	100-240VAC/DC	100-240VAC/DC	100-240VAC/DC (12-24VAC/DC)	100-240VAC/DC	100-240VAC/DC
Input Signal	Pulse Start & Reset	Contact or solid-state [H]: 4~30V [L]: 0~2V Input ≥ 4.7kΩ	Contact or solid-state [H]: 4~30V [L]: 0~2V Input ≥ 4.7kΩ	Contact or solid-state [H]: 4~30V [L]: 0~2V Input ≥ 4.7kΩ	DC 4-30V
Output	2 C/O 3A@250VAC	1 C/O 3A@250VAC	1 C/O 3A@250VAC	-	-
Memory Backup	-	10 years	10 years	10 years	5 years

TIME SWITCHES



RHOMBERG

DIN Rail Electronic Time Switches



DHC15A / DHC15A -20A



DHC20

Code	No. of channels	Time Range	Total No. of programmes	Working Reserve	Minimum Interval	Width in DIN	Relay Output
DHC15A*	1	24hrs/7days	8 On / 8 Off	150 Hours	1 min	2 Modules	SPDT 16A (1 x C/O)
DHC15A-20A	1	24hrs/7days	8 On / 8 Off	150 Hours	1 min	2 Modules	SPDT 20A (1 x C/O)
DHC20	1	24hrs	48 On / 48 Off	150 Hours	15 min	3 Modules	SPDT 16A (1 x C/O)

• Easy to program • Manual ON/ OFF/ AUTO override • LCD Display with backlight

* Special Supply Voltages Available - Add Voltage to code: **12/24V**(12-24VAC/DC)

INDUSTRIAL RELAYS

Type	8 Pin Plug-in Relay Flat	14 Pin Plug-in Relay Flat	8 Pin Plug-in Relay Flat	14 Pin Plug-in Relay Flat
RELAYS - Test button function - Flag plus LED - Orange for AC - Blue for DC				
Relay Type	2 Pole Change Over (5A)	4 Pole Change Over (5A)	2 Pole Change Over (10A)	4 Pole Change Over (10A)
*AC	*DC	*Add voltage to code	*Add voltage to code	*Add voltage to code
230VAC	—	R5502-*L	R5504-*L	R5602-*L
110VAC	110VDC	R5502-*L	R5504-*L	R5602-*L
48VAC	48VDC	R5502-0*L	R5504-0*L	R5602-0*L
24VAC	24VDC	R5502-0*L	R5504-0*L	R5602-0*L
12VAC	12VDC	R5502-0*L	R5504-0*L	R5602-0*L
Wiring Diagram				

Bases for R5502 & R5504 Relays - 300V/10A IP20

Bases for R5602 & R5604 Relays - 300V/10A IP20

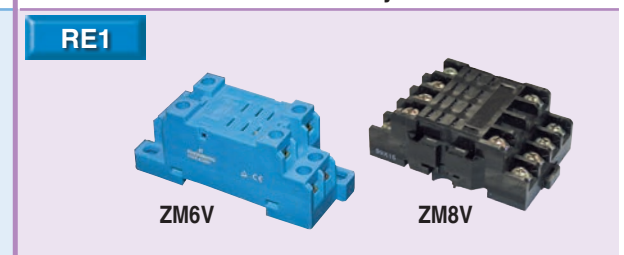

Code	Description
RB943-08F	8 Pin blue screw terminal base for 2 pole relays
RB944-14F	14 Pin blue screw terminal base for 2 & 4 pole relays

Code	Description
ZM6V	Screw Terminal Base for R5602
ZM8V	Screw Terminal Base for R5604

AB - Series Relays 10A

2 C/O 10A	3 C/O 10A	Volts	
		AC	DC
AB2	AB3	12 VAC	12 VDC
AB2	AB3	24 VAC	24 VDC
AB2	—	48 VAC	48 VDC
AB2	AB3	110 VAC	110 VDC
AB2	AB3	230 VAC	—

Bases for AB2 & AB3 Relays - 250V/10A IP20



Code	Description
ZAV/A	Screw Terminal Base for AB2/AB3 relay
ZACS	P.C.B. base for AB2/AB3 relay

Interface Relays

Bases for Interface Relays - IP20

*Add coil voltage to code: 230VAC, 110VAC, 24VDC, 12VDC

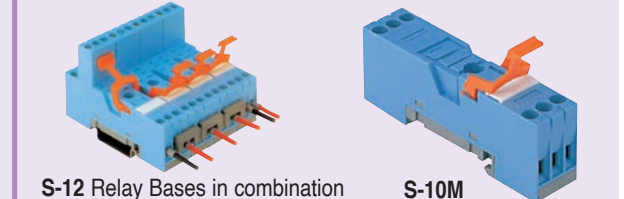
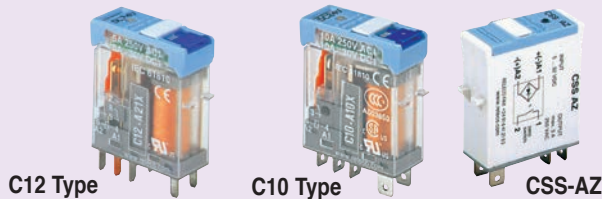

Code	Description
C10/A10/*	1 c/o 10A relay, plug-in type
C12/A21/*	2 c/o 5A relay, plug-in type
CSS-AZ	Solid-state relay, Input 5-32VAC Out switch 3A@250VAC

Code	Description
S-12	Base for C12 relay 250V/5A
S-10M	Base for C10/C14 relay 250V/16A

INDUSTRIAL RELAYS

Type	8 Pin Plug-in Relay	11 Pin Plug-in Relay	8 Pin Plug-in Relay	11 Pin Plug-in Relay
UL recognised, CE approval				
Colour coding: Orange: AC Blue: DC				
Relay type	2 Pole Change Over (10A)	3 Pole Change Over (10A)	2 Pole Change Over (10A)	3 Pole Change Over (10A)
*AC *DC	*Add voltage to code	*Add voltage to code	*Add voltage to code	*Add voltage to code
240VAC —	R6002-*L	R6003-*L	—	—
230VAC 220VDC	R6002-*L	R6003-*L	C2/A20/*	C3/A30/*
110VAC 110VDC	R6002-*L	R6003-*L	C2/A20/*	C3/A30/*
48VAC 48VDC	R6002-0*L	R6003-0*L	C2/A20/*	C3/A30/*
36VAC 36VDC	R6002-0*L	R6003-0*L	C2/A20/*	C3/A30/*
32VAC 32VDC	R6002-0*L	R6003-0*L	C2/A20/*	C3/A30/*
24VAC 24VDC	R6002-0*L	R6003-0*L	C2/A20/*	C3/A30/*
12VAC 12VDC	R6002-0*L	R6003-0*L	C2/A20/*	—
6VAC 6VDC	R6002-00*L	R6003-00*L	C2/A20/*	C3/A30/*
Features	Test button function Flag plus LED	Test button function Flag plus LED	Test button function & Flag ind	Test button function & Flag ind
Wiring Diagram				

Screw Terminal Bases for R6002 & R6003 Relays - IP20 300V/10A



BUV-B



RB750-08R

Code	Description
BOV-B	8 Pin oval base blue
BUV-B	11 Pin oval base blue
RB750-08R	8 Pin rectangle base blue
RB740-11R	11 Pin rectangle base blue

Screw Terminals - IP20 300V/10A



RB113-11R



RB083-08R

Code	Description
RB083-08R	8 Pin rectangle base blue
RB113-11R	11 Pin rectangle base blue

Screw Terminals - IP20 300V/10A



PM-S11D

Retainer clip secures relay to the socket protecting against vibration

Bases for C2/A20 & C3/A30 IP20 250V/10A



S2-B



S3-B

Unique retainer clip securing module to socket providing protection against vibration.

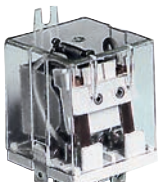

A - Series Relays - For use with fast-on connectors



A1/2

Type	1 N/O 30A	1 N/C 30A	2 N/O 16A	1 C/O 16A	Coil Volts	
					AC	DC
RE1	A1/1	-	A1/2	A1/A	12 VAC	12 VDC
	A1/1	-	A1/2	A1/A	24 VAC	24 VDC
	A1/1	-	A1/2	A1/A	110 VAC	-
	A1/1	A1/R	A1/2	A1/A	230 VAC	-

Timers IP40







Code	Description
CT2A *	8 Pin Delay OFF timer
CT3A *	11 Pin Delay OFF timer
CT2B *	8 Pin Equal Repeating timer
CT3B *	11 Pin Equal Repeating timer
CT2E *	8 Pin Delay ON timer
CT3E *	11 Pin Delay ON timer
CT2K *	8 Pin one-shot pulse start timer
CT3K *	11 Pin one-shot pulse start timer
CT2W *	8 Pin one-shot timer
CT3W *	11 Pin one-shot timer

*Add voltage to code:
S (9.5-18VDC for timer A, B, E, K & W)
L (20-65VAC/DC, for timer A, B, E, K & W)
M (90-150VAC/DC for timer A & K),
U (180-265VAC/DC for timer A & K),
H (90-265VAC/DC for timer B, E & W)

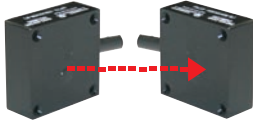
The module **CT2** & **CT3** are electronic timers which are designed to be inserted between a standard plug-in relay and its socket, enabling the relay to be operated as a timer relay. The relay coil voltage must be in the range shown for each model.

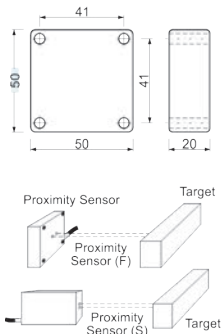
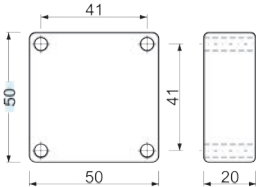
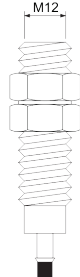
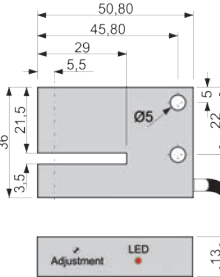
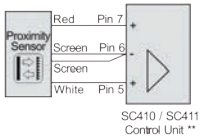
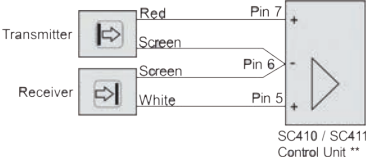
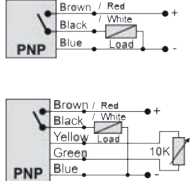
OPTO ELECTRONIC SENSORS

Type	Opto - Proximity	Opto - Barrier Sets		Opto - Fork Sensor
				
Specifications	IP66	IP66	IP67	IP67
Sensing Distance	2m	10m	5m	3.5mm
Supply Voltage	Select control voltage when ordering SC410/SC411 control relay			
Setting	Sensitivity Trimmer	Sensitivity Trimmer		Sensitivity Trimmer
Output Current	-	-	-	400mA
Current Consumption	-	-	-	< 10mA
Voltage Drop	-	-	-	2V max
Operation Mode	Dark or Light	Dark or Light	Dark or Light	Dark or Light
Operating Temperature	0...70°C	0...70°C	0...70°C	0...70°C
Dimensions				
Code				
Front Sensing	RO2-5005P-NOMBC	RO2-5010B-NOMBC (pair)	RO2-1210B-NOMTC (pair)	
Side Sensing	RO2-2005P-NOMBC	RO2-2010B-NOMBC (pair)		
Fork Sensing PNP				RO4-2003B-NOMBC
Fork Sensor PNP with remote sensitivity adjustment				RO4-2503B-NOMBC
Separate Parts (i.e. not Tx+Rx)				
Front Transmitter		RO2-5010T-NOMBC	RO2-1210T-NOMTC	
Front Receiver		RO2-5010R-NOMBC	RO2-1210R-NOMTC	
Side Transmitter		RO2-2010T-NOMBC		
Side Receiver		RO2-2010R-NOMBC		
Wiring Diagram				
SC410/SC411 (See Page 11)	<p>PROXIMITY SYSTEM</p>  <p>SC410 / SC411 Control Unit **</p> <p>**See Page 11 for Control Unit</p>	<p>BARRIER SYSTEM</p>  <p>SC410 / SC411 Control Unit **</p> <p>**See Page 11 for Control Unit</p>		

CAPACITIVE SENSORS IP67

Diameter Ø	Ø M12		Ø M18		Ø M30		1,5 "BSP	
● Flush ○ Surface	●	○	●	○	●	○	○	
Specifications								
Sensing Distance	4mm	8mm	8mm	15mm	20mm	30mm	20mm	
Supply Voltage	10..30VDC		10..30VDC		10..30VDC		20-250VAC 50/60Hz	10-60VDC
Current Consumption	<9 mA		<9 mA		<9 mA		2.5 mA	10 mA
Output Current	200 mA		200 mA		200 mA		400 mA (min: 10mA)	400 mA
Voltage Drop	2 V @ 200 mA		2 V @ 200 mA		2 V @ 200 mA		2 V @ 200 mA	2 V @ 200 mA
Adjustment	Multi-turn Pot		Multi-turn Pot		Multi-turn Pot		Multi-turn Pot	Multi-turn Pot
Switching Frequency	100 Hz		100 Hz		100 Hz		10 Hz	80 Hz
Operating Temp.	-25 to +70 °C		-25 to +70 °C		-25 to +70 °C		-10 to +65 °C	-10 to +65 °C
Hysteresis	<4 %		<4 %		<4 %		<5 %	<5 %
Cable Length	2 meters, PVC		2 meters, PVC		2 meters, PVC		Terminal	Terminal
Cable Section	3 wire		2 wire or 3 wire		2 wire or 3 wire		Connection	Connection
Housing Material	Nickel Plated Brass		Nickel Plated Brass		Nickel Plated Brass		PVC	PVC

Dimensions

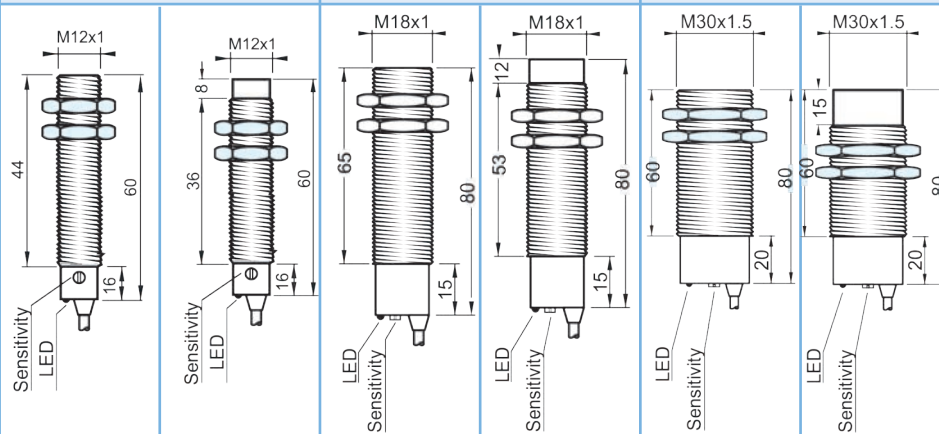

Code

DC Sensors	Flush	Surface	Flush	Surface	Flush	Surface
PNP NO, Cable	CS4-1204F-NOMTC	CS4-1208S-NOMTC	CS4-1808F-NOMTC	CS4-1815S-NOMTC	CS4-3020F-NOMTC	CS4-3030S-NOMTC
PNP NC, Cable	CS4-1204F-NCMTC	CS4-1208S-NCMTC	CS4-1808F-NCMTC	CS4-1815S-NCMTC	CS4-3020F-NCMTC	CS4-3030S-NCMTC
NPN NO, Cable	CS5-1204F-NOMTC	CS5-1208S-NOMTC	CS5-1808F-NOMTC	CS5-1815S-NOMTC	CS5-3020F-NOMTC	CS5-3030S-NOMTC
NPN NC, Cable	CS5-1204F-NCMTC	CS5-1208S-NCMTC	CS5-1808F-NCMTC	CS5-1815S-NCMTC	CS5-3020F-NCMTC	CS5-3030S-NCMTC
PNP NO, Plug	CS4-1204F-NOMTP	CS4-1208S-NOMTP	CS4-1808F-NOMTP	CS4-1815S-NOMTP	CS4-3020F-NOMTP	CS4-3030S-NOMTP
PNP NC, Plug	CS4-1204F-NCMTP	CS4-1208S-NCMTP	CS4-1808F-NCMTP	CS4-1815S-NCMTP	CS4-3020F-NCMTP	CS4-3030S-NCMTP
NPN NO, Plug	CS5-1204F-NOMTP	CS5-1208S-NOMTP	CS5-1808F-NOMTP	CS5-1815S-NOMTP	CS5-3020F-NOMTP	CS5-3030S-NOMTP
NPN NC, Plug	CS5-1204F-NCMTP	CS5-1208S-NCMTP	CS5-1808F-NCMTP	CS5-1815S-NCMTP	CS5-3020F-NCMTP	CS5-3030S-NCMTP

AC Sensors

2-Wire NO Cable 20-250VAC	-	-	CS1-1808F-NOMTC	CS1-1815S-NOMTC	CS1-3020F-NOMTC	CS1-3030S-NOMTC
2-Wire NC Cable 20-250VAC	-	-	CS1-1808F-NCMTC	CS1-1815S-NCMTC	CS1-3020F-NCMTC	CS1-3030S-NCMTC

Wiring Diagram

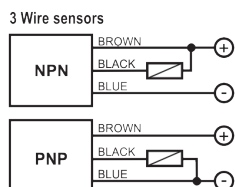

AC 2 Wire

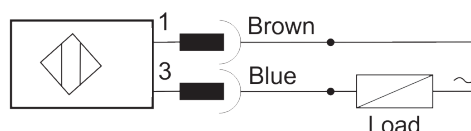

NAMUR

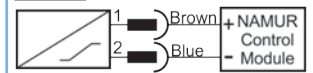

Code: RC0-4020S-NCPBT

AC 2-Wire: 0.4A fuse protection required

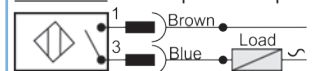

Code: RC1-4020S-NOPBT -NCPBT

DC PNP 3-Wire

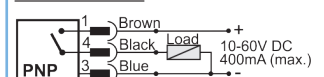

Code: RC4-4020S-NOPBT -NCPBT

DC NPN 3-Wire

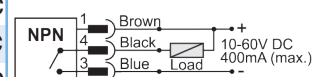

Code: RC5-4020S-NOPBT -NCPBT

NAMUR

Requires a suitable control module to operate

2-Wire AC

Supply Voltage: 20 to 250VAC, 50/60Hz
Minimum Load Current: 10mA
Continuous Load Current: 400mA
Off-state Quiescent Current: ≤2.5mA at 250V AC

These sensors are not protected against sustained over current fault conditions. The fitting of an external inline 0.4A fuse is therefore advised.

DC Sensors are to be connected to a DC power supply and can switch loads (e.g. Relays, solenoids, PLC's) directly.
Supply Voltage: 10 to 60V DC
Maximum Ripple: 10%
Maximum Load Current: 400mA
Quiescent Current: <10mA
Polarity Protection: Yes
Overload Protection: Yes
Short Circuit Protection: Yes

For Sensor Cables see Page 32

NAMUR INDUCTIVE & CAPACITIVE SENSORS IP68 (DIN 19234)

Inductive

Diameter Ø	Ø M12		Ø M18		Ø M30		Ø M40	
	● Flush	○ Surface	● Flush	○ Surface	● Flush	○ Surface	● Flush	○ Surface
Specifications								
Sensing Distance	2mm	4mm	5mm	8mm	10mm	15mm	20mm	25mm
Supply Voltage	8,2 - 10VDC (via module)		8,2 - 10VDC (via module)		8,2 - 10VDC (via module)		8,2 - 10VDC (via module)	
Current Consumption	≤ 2 mA		≤ 2 mA		≤ 2 mA		≤ 2 mA	
Output Current (Metal present)	0,8mA Typical		0,8mA Typical		0,8mA Typical		0,8mA Typical	
Output Current (Metal absent)	4mA Typical		4mA Typical		4mA Typical		4mA Typical	
Switching Frequency	2000Hz		1000Hz		500Hz		500Hz	
Operating Temp.	-20 to +70 °C		-20 to +70 °C		-20 to +70 °C		-20 to +70 °C	
Hysteresis	3 to 15%		3 to 15%		3 to 15%		3 to 15%	
Cable Length	2m		2m		2m		2m	
Cable Section	2 Wire		2 Wire		2 Wire		2 Wire	
Housing Material	Aluminium		Aluminium		Aluminium		Aluminium	
Dimensions								
Ex ia, Gr 2C, T6								
NAMUR (To DIN 19234)								
Code	Flush	Surface	Flush	Surface	Flush	Surface	Flush	Surface
NAMUR NC, Cable	RI0-1202F-NCMTC	RI0-1204S-NCMTC	RI0-1805F-NCMTC	RI0-1808S-NCMTC	RI0-3010F-NCMTC	RI0-3015S-NCMTC	RI0-4020F-NCMTC	RI0-4025S-NCMTC
NAMUR NC, Plug	-	-	RI0-1805F-NCMTP	RI0-1808S-NCMTP	RI0-3010F-NCMTP	RI0-3015S-NCMTP	-	-

Capacitive

Diameter Ø	Ø M30	
● Flush	● Flush	○ Surface
M30 also available	Flush	Surface
NC, Metal, Cable	RC0-3010F-NCMTC	RC0-3020S-NCMTC
NC, Metal, Plug	RC0-3010F-NCMTP	RC0-3020S-NCMTP

Wiring Diagrams

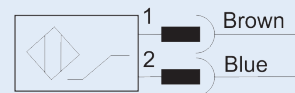

Ex ia, Gr T6 NAMUR sensors require a suitably approved control module to operate in intrinsically safe areas. (Please request more information)

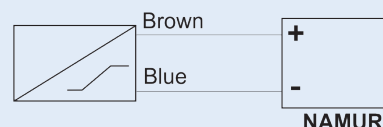

For Sensor Cables see Page 32 **NAMUR Control Module**

NAMUR sensors require a suitable Slimline Control Module to operate **SC300** or **SC301**

AC INDUCTIVE SENSORS IP68

Diameter Ø	Ø M12		Ø M18		Ø M30		Ø M40	
● Flush ○ Surface	●	○	●	○	●	○	●	○
Specifications								
Sensing Distance	2mm	4mm	5mm	8mm	10mm	15mm	20mm	25mm
Supply Voltage	20 - 250VAC		20 - 250VAC		20 - 250VAC		20 - 250VAC	
Current Consumption	≤2 mA		≤2 mA		≤2 mA		≤2 mA	
Output Current	400mA		400mA		400mA		400mA	
Switching Frequency	10Hz		10Hz		10Hz		10Hz	
Operating Temp.	-20 to +70 °C		-20 to +70 °C		-20 to +70 °C		-20 to +70 °C	
Hysteresis	3 to 15%		3 to 15%		3 to 15%		3 to 15%	
Cable Length	2m		2m		2m		2m	
Cable Section	2 Wire		2 Wire		2 Wire		2 Wire	
Housing Material	Aluminium		Aluminium		Aluminium		Aluminium	
Dimensions								
Code	Flush	Surface	Flush	Surface	Flush	Surface	Flush	Surface
NO, Cable	RI1-1202F-NOMTC	RI1-1204S-NOMTC	RI1-1805F-NOMTC	RI1-1808S-NOMTC	RI1-3010F-NOMTC	RI1-3015S-NOMTC	RI1-4020F-NOMTC	RI1-4025S-NOMTC
NC, Cable	RI1-1202F-NCMTC	RI1-1204S-NCMTC	RI1-1805F-NCMTC	RI1-1808S-NCMTC	RI1-3010F-NCMTC	RI1-3015S-NCMTC	RI1-4020F-NCMTC	RI1-4025S-NCMTC
NO, Plug	RI1-1202F-NOMTP	RI1-1204S-NOMTP	RI1-1805F-NOMTP	RI1-1808S-NOMTP	RI1-3010F-NOMTP	RI1-3015S-NOMTP	-	-
NC, Plug	RI1-1202F-NCMTP	RI1-1204S-NCMTP	RI1-1805F-NCMTP	RI1-1808S-NCMTP	RI1-3010F-NCMTP	RI1-3015S-NCMTP	-	-

For M12 Connector, Cable & Terminal DC Sensors



Code	Description
ST-02	<ul style="list-style-type: none"> • PNP (sourcing) and NPN (sinking) Testing • M12-5-Pin Plug Input • Terminal Inputs • Two Output LED's • Battery Powered



Wiring Diagrams

Cable Type:

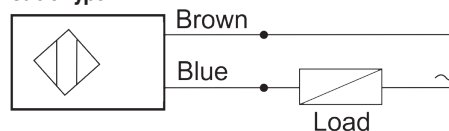

Plug Type:

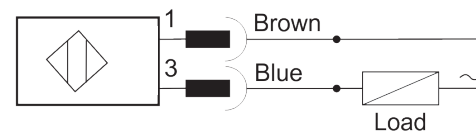

For Sensor Cables see Page 32

Note: These sensors are not protected against sustained over current fault conditions. The fitting of an external inline 0.4A fuse is therefore advised

DC INDUCTIVE SENSORS

Diameter Ø	ØM12		ØM18		ØM30		ØM40	
● Flush ○ Surface	●	○	●	○	●	○	●	○
Sensing Distance	2mm	4mm	5mm	8mm	10mm	15mm	20mm	25mm
Supply Voltage	10 - 30VDC		10 - 30VDC		10 - 30VDC		10 - 30VDC	
Current Consumption	< 8 mA		< 8 mA		≤ 10 mA		≤ 10 mA	
Output Current	200 mA		200 mA		400 mA		400 mA	
Voltage Drop	< 1,5 V @ 200 mA		< 1,5 V @ 200 mA		≤ 2V		≤ 2V	
Switching Frequency	1000 Hz	500 Hz	300 Hz	500 Hz	100 Hz	500 Hz	1000 Hz	500 Hz
Operating Temp.	-25 to +70 °C		-25 to +70 °C		-20 to +70 °C		-20 to +70 °C	
Hysteresis	3 ...15%		3 ...15%		3 ...15%		3 ...15%	
Cable length	2 meters, PVC		2 meters, PVC		2 meters, PVC		2 meters, PVC	
Cable section	3 Wire		3 Wire		3 Wire, 4 Wire(NX)		3 Wire, 4 Wire(NX)	
Housing Material	Nickel Plated Brass		Nickel Plated Brass		Aluminium		Aluminium	

Wiring Diagram

3 Wire sensors

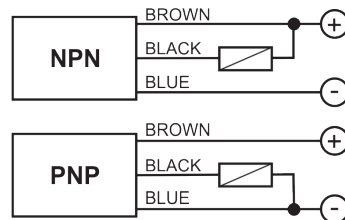

3 and 4 Wire (NX) sensors

4 Wire NX sensors available in M12 and M18

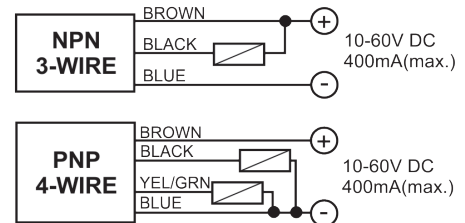

For Sensor Cables see page 32

	Flush	Surface	Flush	Surface	Flush	Surface	Flush	Surface
PNP NO, Cable	IS4-1202F-NOMTC	IS4-1204S-NOMTC	IS4-1805F-NOMTC	IS4-1808S-NOMTC	RI4-3010F-NOMTC	RI4-3015S-NOMTC	RI4-4020F-NOMTC	RI4-4025S-NOMTC
PNP NC, Cable	IS4-1202F-NCMTC	IS4-1204S-NCMTC	IS4-1805F-NCMTC	IS4-1808S-NCMTC	RI4-3010F-NCMTC	RI4-3015S-NCMTC	RI4-4020F-NCMTC	RI4-4025S-NCMTC
PNP NO/NC, Cable	RI4-1202F-NXMTC	RI4-1204S-NXMTC	RI4-1805F-NXMTC	RI4-1808S-NXMTC	RI4-3010F-NXMTC	RI4-3015S-NXMTC	RI4-4020F-NXMTC	RI4-4025S-NXMTC
PNP NO, Plug	IS4-1202F-NOMTP	IS4-1204S-NOMTP	IS4-1805F-NOMTP	IS4-1808S-NOMTP	RI4-3010F-NOMTP	RI4-3015S-NOMTP	-	-
PNP NC, Plug	IS4-1202F-NCMTP	IS4-1204S-NCMTP	IS4-1805F-NCMTP	IS4-1808S-NCMTP	RI4-3010F-NCMTP	RI4-3015S-NCMTP	-	-
PNP NO/NC, Plug	RI4-1202F-NXMTP	RI4-1204S-NXMTP	RI4-1805F-NXMTP	RI4-1808S-NXMTP	RI4-3010F-NXMTP	RI4-3015S-NXMTP	-	-
NPN NO, Cable	IS5-1202F-NOMTC	IS5-1204S-NOMTC	IS5-1805F-NOMTC	IS5-1808S-NOMTC	RI5-3010F-NOMTC	RI5-3015S-NOMTC	RI5-4020F-NOMTC	RI5-4025S-NOMTC
NPN NC, Cable	IS5-1202F-NCMTC	IS5-1204S-NCMTC	IS5-1805F-NCMTC	IS5-1808S-NCMTC	RI5-3010F-NCMTC	RI5-3015S-NCMTC	RI5-4020F-NCMTC	RI5-4025S-NCMTC
NPN NO/NC, Cable	RI5-1202F-NXMTC	RI5-1204S-NXMTC	RI5-1805F-NXMTC	RI5-1808S-NXMTC	RI5-3010F-NXMTC	RI5-3015S-NXMTC	RI5-4020F-NXMTC	RI5-4025S-NXMTC
NPN NO, Plug	IS5-1202F-NOMTP	IS5-1204S-NOMTP	IS5-1805F-NOMTP	IS5-1808S-NOMTP	RI5-3010F-NOMTP	RI5-3015S-NOMTP	-	-
NPN NC, Plug	IS5-1202F-NCMTP	IS5-1204S-NCMTP	IS5-1805F-NCMTP	IS5-1808S-NCMTP	RI5-3010F-NCMTP	RI5-3015S-NCMTP	-	-
NPN NO/NC, Plug	RI5-1202F-NXMTP	RI5-1204S-NXMTP	RI5-1805F-NXMTP	RI5-1808S-NXMTP	RI5-3010F-NXMTP	RI5-3015S-NXMTP	-	-

Intelligent Canline Sensor IP67



The Intelligent Can Line Sensor has been specifically designed and developed for detecting the presence and movement of cans and automated can making and can filling lines. When interfaced with Programmable Logic Controller (PLC) the sensor's integrated intelligence released the PLC from time-consuming computing activities.

The Can Line Sensor is versatile enough to be used in a variety of applications.





Some of these are:

- Gap-detection (missing cans)
- Pile-up detection
- Proximity and motion detection
- Built-back control
- Detection of missing tops or crowns on bottling lines

Code	Description
RI4-9020F-NOPBC	PNP, N.O., c/w Fly Lead
RI4-9020F-NOPBP	PNP, N.O., c/w M.Plug
RI5-9020F-NOPBC	NPN, N.O., c/w Fly Lead
RI5-9020F-NOPBP	NPN, N.O., c/w M.Plug

CAN MATERIAL	Sn
Mild Steel	20
Stainless Steel	15
Aluminium	8

PHOTOELECTRIC SENSORS 50mm X 50mm IP65

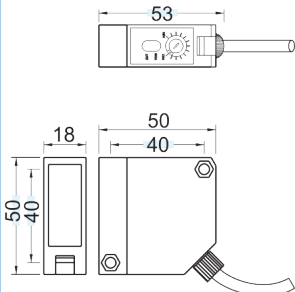
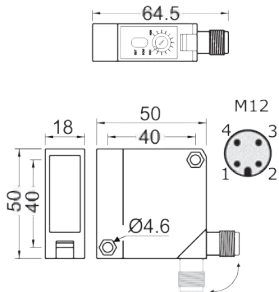
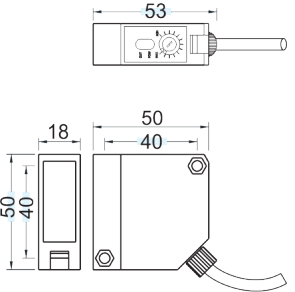
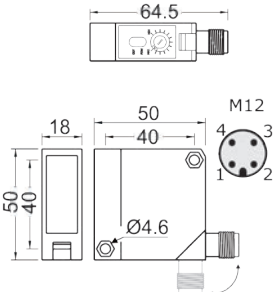
Type	Diffuse		Polarized Reflective	
Cubic Series Integrated Output LED		Relay Output 		Relay Output 
Specifications				
Sensing Distance	300mm...2m	300mm...2m	0...6m	0.6m
Supply Voltage	10... 30 VDC	24...240VDC / VAC	10... 30 VDC	24...240VDC / VAC
Emission	Infra Red LED 800nm	Infra Red LED 800nm	Infra Red LED 800nm	Infra Red LED 800nm
Setting	Sensitivity Trimmer	Sensitivity Trimmer	Sensitivity Trimmer	Sensitivity Trimmer
Output	PNP, NPN, NO, NC Programmable	Relay, SPDT NO+NC	PNP, NPN, NO, NC Programmable	Relay, SPDT NO+NC
Output Current	200mA	1A / 230 VAC	200mA	1A / 230 VAC
Current Consumption	< 37mA	< 2.2W	< 37mA	< 2.2W
Voltage Drop	< 2V@ 200mA	-	< 2V@ 200mA	-
Response Time	< 1ms	< 25ms	< 1ms	< 25ms
Switching Freq.	500 Hz	10 Hz	500 Hz	10 Hz
Operation Mode	Dark or Light	Dark or Light	Dark or Light	Dark or Light
Ingress Protection	IP65	IP65	IP65	IP65
Housing Material	ABS, Lens PMMA	ABS, Lens PMMA	ABS, Lens PMMA	ABS, Lens PMMA
Operating Temp.	-25...55°C	-25...55°C	-25...55°C	-25...55°C
Mounting Bracket	Included	Included	Included	Included
Dimensions				
Code				
PNP, NPN, NO, NC, Cable Programmable	OD50-D2PNCO/2P		OD50-P6PNCO/2P	
PNP, NPN, NO, NC, Plug Programmable	OD50-D2PNCO/M12		OD50-P6PNCO/M12	
relay NC+NO, Cable		OD50-D2ACO/2P		OD50-P6ACO/2P
relay NO, Plug		OD50-D2AO/M12		OD50-P6AO/M12
relay NC, Plug		OD50-D2AC/M12		OD50-P6AC/M12

Wiring Diagram

4 Wire DC



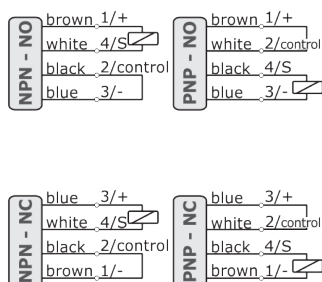

(For Sensor Cables See page 32)

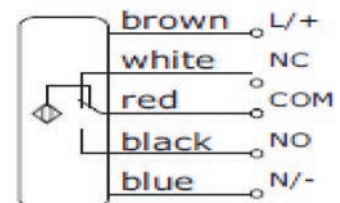

5 Wire DC

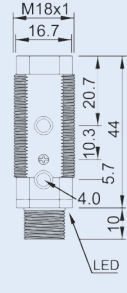
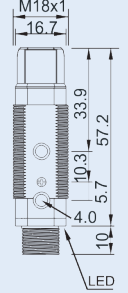
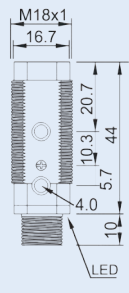
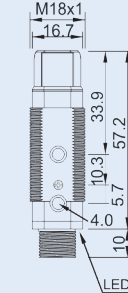

PHOTOELECTRIC SENSORS IP67

Type	Diffuse		Polarized Reflective	
M18 Flat Integrated Output LED				
Specifications				
Sensing Distance	0... 400mm	300mm	1400mm	1200mm
Supply Voltage	10... 30 VDC	10... 30 VDC	10... 30 VDC	10... 30 VDC
Setting	Sensitivity Trimmer	Sensitivity Trimmer	Sensitivity Trimmer	Sensitivity Trimmer
Output	NO NC	NO NC	NO NC	NO NC
Output Current	100mA	100mA	100mA	100mA
Current Consumption	< 30mA	< 30mA	< 30mA	< 30mA
Voltage Drop	< 2V @100mA	< 2V @100mA	< 2V @100mA	< 2V @100mA
Response Time	< 1ms	< 1ms	< 1ms	< 1ms
Switching Freq.	1000 Hz	1000 Hz	1000 Hz	1000 Hz
Operation Mode	Dark or Light	Dark or Light	Dark or Light	Dark or Light
Housing Material	ABS, Lens PMMA	ABS, Lens PMMA	ABS, Lens PMMA	ABS, Lens PMMA
Operating Temp.	-25...55°C	-25...55°C	-25...55°C	-25...55°C
Mounting Bracket	on request	on request	on request	on request
Dimensions				
Code				
PNP, NO+NC Cable	OD18FA-D04PSB/2P	OD18FR-D03PSB/2P	OD18FA-P014PSB/2P	OD18FR-P012PSB/2P
NPN, NO+NC Cable	OD18FA-D04NSB/2P	OD18FR-D03NSB/2P	OD18FA-P014NSB/2P	OD18FR-P012NSB/2P
PNP, NO+NC Plug-in	OD18FA-D04PSB/M12	OD18FR-D03PSB/M12	OD18FA-P014PSB/M12	OD18FR-P012PSB/M12
NPN, NO+NC Plug-in	OD18FA-D04NSB/M12	OD18FR-D03NSB/M12	OD18FA-P014NSB/M12	OD18FR-P012NSB/M12

Wiring Diagram

(For Sensor Cables
See page 32)





Connector M12

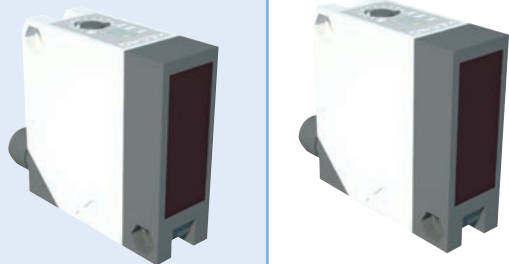

10...30 VDC | Diffuse-Reflective, 2m

PHOTOELECTRIC SENSORS

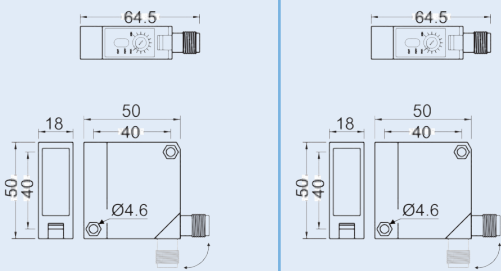
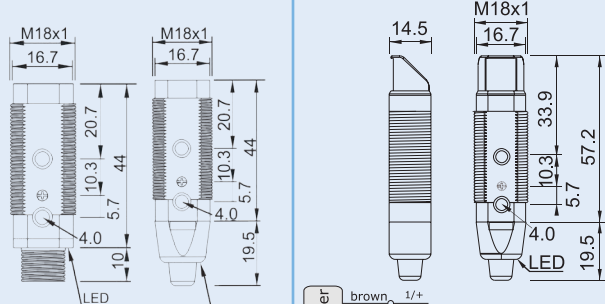
Type	Through Beam Cubic 50x50		Through Beam M18	
Cubic Series Integrated Output LED	Relay Output 		IP67 	
Specifications				
Sensing Distance	18m	18m	10m	9.5m
Supply Voltage	24...240VDC / VAC	10... 30 VDC	10... 30 VDC	10 - 30VDC
Emission	Infra Red LED 800nm	Infra Red LED 800nm	Infra Red LED 800nm	Infra Red LED 800nm
Setting	Sensitivity Trimmer	Sensitivity Trimmer	Sensitivity Trimmer	Sensitivity Trimmer
Output	Relay, NO or NC (order option)	PNP, NPN, NO, NC Programmable	NO, NC	NO, NC
Output Current	1A / 230 VAC	200mA	100mA	100mA
Current Consumption	< 2.2W	< 37mA	< 30mA	< 30mA
Voltage Drop	-	< 2V@ 200mA	< 2V@ 100mA	<2V@100mA
Response Time	<25ms	< 1ms	< 1ms	< 1ms
Switching Freq.	10 Hz	500 Hz	1000 Hz	1000 Hz
Operation Mode	Dark or Light	Dark or Light	Dark or Light	Dark or Light
Ingress Protection	IP65	IP65	IP67	IP67
Housing Material	ABS, Lens PMMA	ABS, Lens PMMA	ABS, Lens PMMA	ABS, Lens PMMA
Operating Temp.	-25...55°C	-25...55°C	-25...55°C	-25...55°C
Mounting Bracket	Included	Included		
Dimensions				
Code				
Transmitters	OD50-T18A/M12	OD50-T18D/M12	OD18FA-T10B/M12	OD18FR-T095B/M12
Receivers:				
SPDT	-	-		
Programmable Receiver	-	OD50-R18PNCO/M12		
PNP, NO+NC Plug			OD18FA-R10PSB/M12 *	OD18FR-R095PSB/M12 *
NPN, NO+NC Plug			OD18FA-R10NSB/M12 *	OD18FR-R095NSB/M12 *
Relay NO, Plug	OD50-R18AO/M12			
Relay NC, Plug	OD50-R18AC/M12			

Connector M12

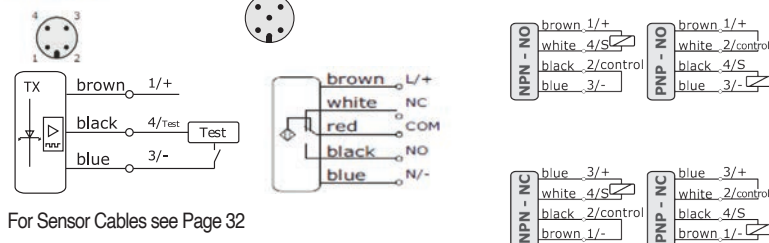

For Sensor Cables see Page 32

* For cable type change M12 to 2P e.g. OD18FA-R095PSB/2P

Connector M12		Connector M12	
GND BL	ON - NdN	GND BL	ON - dNd
GND BK	ON - NdN	OUT BK	ON - BK
OUT WH	ON - NdN	10-30V WH	ON - WH
10-30V BR	ON - NdN	10-30V BR	ON - BR
GND BR	ON - NdN	GND BR	ON - dNd
GND BK	ON - NdN	OUT BK	ON - BK
OUT WH	ON - NdN	10-30V WH	ON - WH
10-30V BL	ON - NdN	10-30V BL	ON - BL

10...30 VDC | Diffuse-Reflective, 2m

ACCESSORIES

Conductive Probe Kits IP65



Coated	CP1/C	CP2/C	CP3/C
Uncoated	CP1	CP2	CP3
• Material: Nylon • Thread: 1.5" BSP • Max Temp: 70°C	c/w 1 x 1m x Ø4mm Rods	c/w 2 x 1m x Ø4mm Rods	c/w 3 x 1m x Ø4mm Rods

Accessories



Code	Description
CP1/CX	1-Way Head only
CP2/CX	2-Way Head only
CP3/CX	3-Way Head only
DD2	2-Way Probe Spacer
DD3	3-Way Probe Spacer
EP1/C	Spare 1m s/s Rod coated
EP1/U	Spare uncoated s/s Rod 1m
EP1/EXT	M4 Connecting Nut Brass

Coating of the rods improves resistance, prevents switching caused by frothing or condensation.

Mounting Brackets

for Proximity Sensors



Code	Description
ST1218	For M12 & M18
ST1830	For M18 & M30

DAT

Connectors and Cables

Dimensions	Cable Length*	Code
Female connector and cable M12 Plug		
90° Version		
<p>DAT</p>	4 Pin 4 Wire	3m 5m
	3 Pin 3 Wire	5m
<p>DAT</p>	Connector with no cable	CS-A2-02-B-NC
	4 Pin 4 Wire	3m 5m
	3 Pin 3 Wire	5m
	Connector with no cable	CS-A1-02-B-NC

Dimensions	Cable Length*	Code
Female connector and cable M8 Plug		
<p>DAT</p>	4 Pin 4 Wire	3m 5m
	3 Pin 3 Wire	3m 5m

Siren Modules

Wail



Yelp



Code	Description
ES/225/*/**	Wail or Yelp 115VAC or 230VAC + 12VDC 8Ω 5Watt

*Add sound to code: 1 = Wail, 2 = Yelp
**Add to code 115VAC or 230VAC

Reflectors

Code	R 2	R 5	DAT
Code	R 4	DAC100	

Pressure Transmitter IP65



PT1X*PR01**

- Accuracy to better than 0.5%FS (including linearity and repeatability)
- Transducer rated at 50 million cycles
- Metalwork made of Type 316 Stainless Steel
- Protected against reverse voltage and overvoltage
- Protected against noise on the supply line
- Wide supply range, 8 to 36VDC - allows a wide range of load resistance
- Transducer is temperature compensated by means of laser-trimmed resistors
- Operating temperature range from 0°C to +85°C
- Internal Trimpots for field calibration

Transmitter

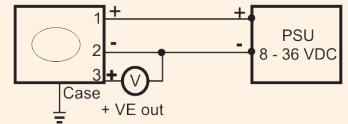

GENERAL SPECIFICATIONS

Output: 4 - 20mA
Excitation: 10 - 36V DC
Accuracy (BFSL): < 0.5% FS
Compensated Temp. Range: 0° to 85° C
Temperature error zero: < -0,02% FS / K
Temperature error span: < -0,01% FS / K (0-70°C)
Ingress protection: IP65
Burst pressure: 1.5 x FS (except when indicated)

Wetted Parts/Connection: 316 Stainless steel, ceramic, Nitrile (Specify media where Nitrile is not compatible)

WIRING CONNECTIONS

- 1 Red: + Us
- 2 Black: - Vs
- 3 Yellow: GND

Code	Transducer Range	Code	Fitting
0010	1 Bar	02	1/4" NPT
0040	4 Bar	04	1/2" NPT
0060	6 Bar	12	1/4" BSP
0100	10 Bar	14	1/2" BSP
0160	16 Bar		
0250	25 Bar		
0400	40 Bar		
1000	100 Bar		
4000	400 Bar		

Other options available



CON

Other options available





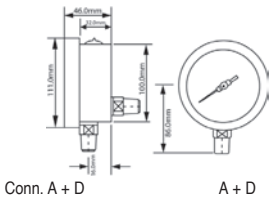
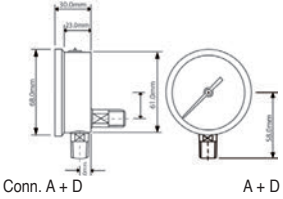
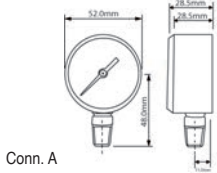

PRODUCT RANGE	TRANSDUCER RANGE	PRESSURE	FITTING
PT1X	*	P	** R01

*10m versions available on request

PROCESS GAUGES

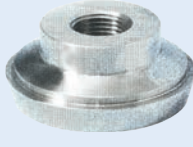
Type	Stainless Steel Case	Robust Liquid Filled	Economic										
													
Code	PBB-* - ** - *** - **** - *****	PBG-* - ** - *** - **** - *****	PBN-* - ** - *** - **** - *****										
Connection A-Bottom Connection D-Rear Connection	This gauge is ideally suited to most industrial applications where high accuracy and durability is required. Gauges are available with either brass/bronze internals, all stainless steel internals, or Manel Bourdan tube and socket with stainless steel movement.	For heavy duty services where vibration or shock of medium would cause excessive wear on a dry gauge or corrosive ambient conditions prevail. Applications include hydraulic equipment, mining equipment and irrigation.	For non-corrosive liquids and gases on light duty service in more corrosive environments. Applications include coastal application for valve positioner and regulators, swimming pool pumps and stationary irrigation systems.										
Case	Brush finish 304 SS, Bayonet Bezel	304 SS, Crimped Bezel	Steel Black, Powder Coated										
Internals	Available with either Brass/Bronze, or SS	Brass	Brass										
Range (Max)	6000 kPa	6000 kPa	6000 kPa										
Temperature	-25°C to 60°C	-25°C to 60°C	-25°C to 60°C										
Accuracy	100Ø 1% @ FSD / 63Ø 1.6% @FSD	1.6% @ FSD	1.6% @ FSD										
Configuration													
Thread	<table border="1"> <thead> <tr> <th>Code</th> <th>Fitting</th> </tr> </thead> <tbody> <tr> <td>02</td> <td>1/4 NPT</td> </tr> <tr> <td>04</td> <td>1/2 NPT</td> </tr> <tr> <td>12</td> <td>1/4 BSP</td> </tr> <tr> <td>14</td> <td>1/2 BSP</td> </tr> </tbody> </table> <p>Add to code</p>			Code	Fitting	02	1/4 NPT	04	1/2 NPT	12	1/4 BSP	14	1/2 BSP
Code	Fitting												
02	1/4 NPT												
04	1/2 NPT												
12	1/4 BSP												
14	1/2 BSP												
* Connection	A (Bottom) & D (Rear)		A (Bottom) only										
** Add size (mm)	63 100	63 only	54 only										
*** System material	BB&SS		BB										
**** Thread size	02, 12 02, 04, 12, 14	02, 12	02, 12										
***** Add pressure	100kPa, 160kPa, 250kPa, 400kPa, 600kPa, 1000kPa, 1600kPa, 2500kPa, 4000kPa, 6000kPa. Other ranges available on request.												

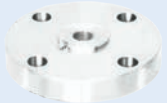
Process Gauges Accessories

Steam Line Piping	Valve	Dairy Seals		Chemical Seals	Flanged Seals
					
Code U-TYPE	Code VG ISOLATE	Code	NW40-* NW50-*	XWD4-*	NFD01-*
	Isolation valves and gauge cocks to isolate pressure from gauge. Equipped with a facility to vent the gauge. Suitable for use with gases, liquids and vapours. Material - Brass	Material Max Pressurer Gauge Port Application	Grade 316 SS 40 MPA 1/4", NPT or BSP Is used in health and dairy application, can be used for pulp/paper. For non-corrosive liquids and gases on light duty service in more corrosive environments.	316 Stainless Steel 150 Mpa 1/4" or 1/2", NPT or BSP Is used in applications where the process fluid (medium) is corrosive or viscous (could even contain waste particles) and could clog the instruments internals.	Grade 316 SS 150 Mpa 1/4" and 1/2", NPT Flanged seals, one for continuous use for safety concerns. Cleanout type for easy cleaning with flushing connections available.
Code PIGTAIL		Thread Size	*Add Thread Type to Code: 02, 12	*Add Thread Type to Code: 02, 04,12,14	*Add Thread Type to Code: 02, 04
• Steam line piping should be installed on all live steam applications to protect the gauge from the high temperatures encountered. • Available in either "pigtail" or "U-type" configurations for installation on horizontal or vertical line respectively Material - Steel.					

HOUSING DIMENSIONAL DIAGRAMS

Slimline

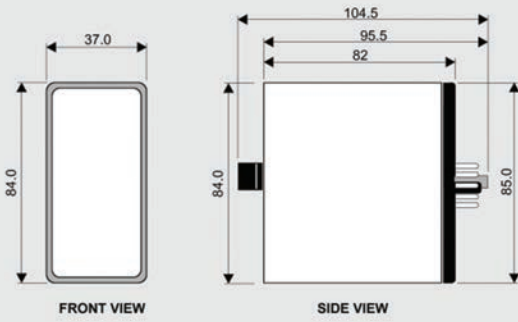

Housing Colour: Base Grey / Cover: Blue
Housing Material: Polycarbonate

A-Line & Protector

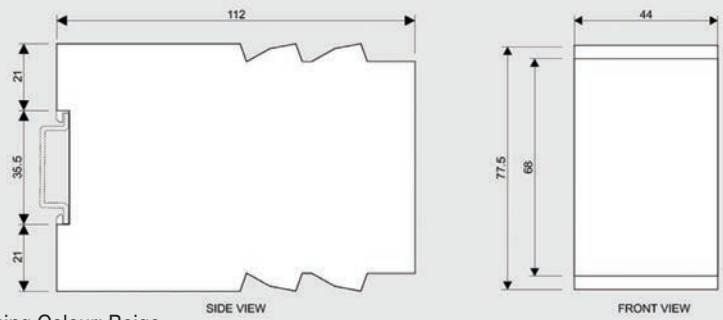

Housing Colour: Beige
Housing Material: Nylon 66

48x48 Timers

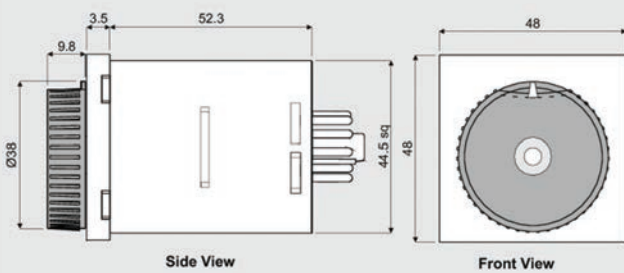

Housing Colour: Beige
Housing Material: ABS/Polycarbonate

Industrial Relays

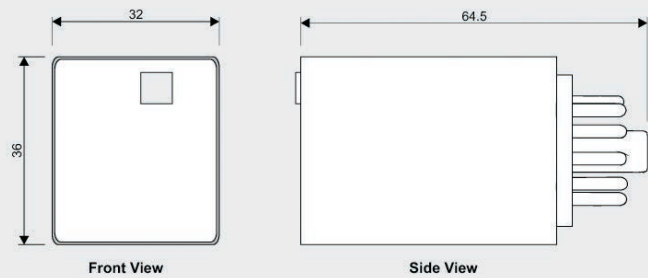

Housing Colour: Clear
Housing Material: ABS/Polycarbonate

Countline

CC-120

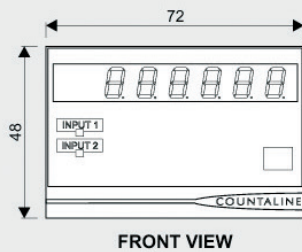

FRONT VIEW

CC-701

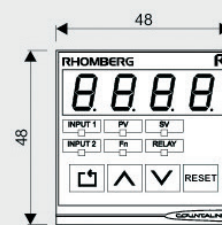

FRONT VIEW

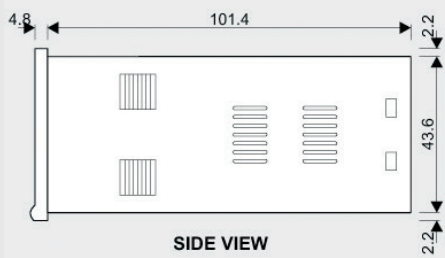

SIDE VIEW

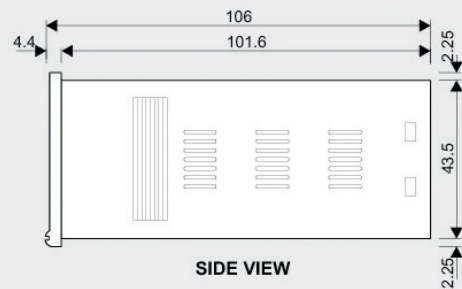

SIDE VIEW



TOP VIEW



TOP VIEW

Housing Colour: Charcoal
Housing Material: ABS/Polycarbonate

SLIMLINE INTERNAL RELAY SPECIFICATION

Ambient Temperature: Operation: -40°C ~ 70°C

AC Supply Frequency: 40 – 70Hz

Safety Approvals	UL&CUR	TuV	CQC
Load	2C: 5A/220VAC	1C: 10A/250VAC, 14VDC 2C: 5A/250VAC, 30VDC	1C: 10A/250VAC

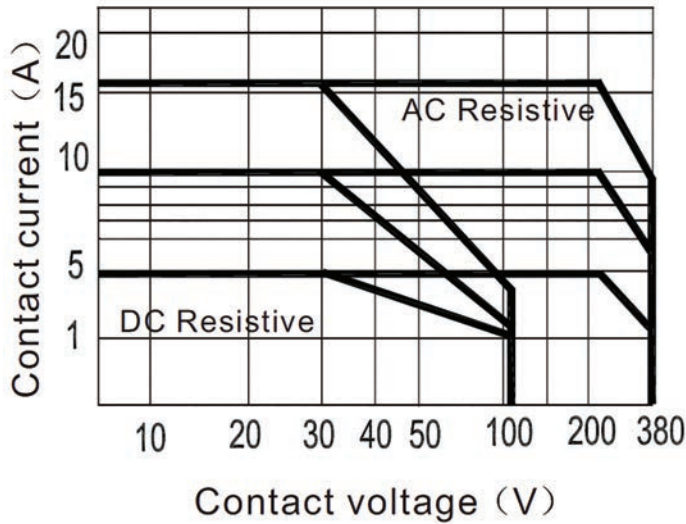

Contact Rating	SPDT	DPDT
Rated Load	10A	5A
Max Switching Current	10A	5A
Max Switching Voltage	380VAC, 110VDC	380VAC, 110VDC
Max Switching Power	600W, 500VA	600W, 5000VA

Contact Data		Characteristics	
Material	AgCdO	Insulation Resistance	1000MΩ min (at 500VDC)
Contact Resistance	<50mΩ	Dielectric Strength	Between contacts – 50Hz 1000V Between contact and coil – 50Hz 5000V
Service Life: Mechanical	10 ⁷ ops	Shock Resistance	100m/s ² 11mS
Electrical	10 ⁵ ops	Vibration Resistance	10Hz ~ 50Hz amplitude 1.5mm

Spark Quenching & C.T. Protection

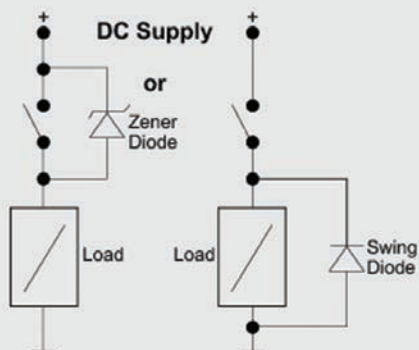

Note: Voltage rating of the (Zener) diode should be higher than the DC supply voltage. Observe the correct polarity.

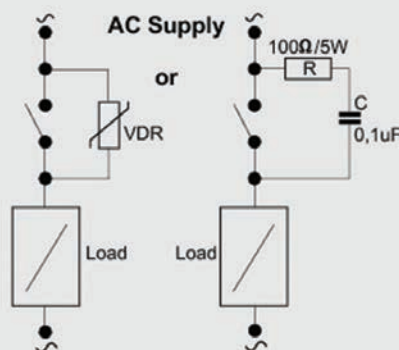

Note: Voltage rating of the VDR or the capacitor "C" must be higher than the supply voltage. Different values for "R" and "C" may have to be chosen, depending on the load.

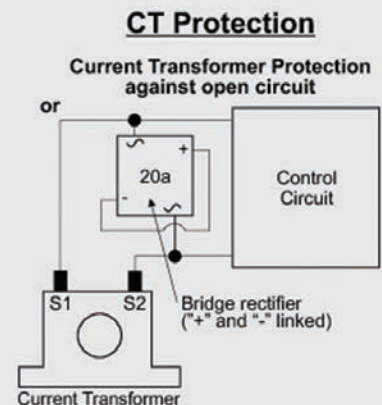

Note: Connection of the bridge rectifier to be as close as possible to the current transformer. CT protection.

RHOMBERG

ACDCTM
DYNAMICS
www.acdc.co.za

LONGMEADOW

26 Nguni Drive, Longmeadow
Business Estate West, Edenvale
Gauteng

Tel: +27 10 202 3300

Fax: +27 10 202 3365

Email: info@acdc.co.za

GERMISTON

Sharland Street, Driehoek,
Germiston, Gauteng

Tel: +27 11 418 9600

Fax: +27 11 418 9633

Email: germiston@acdc.co.za

CAPE TOWN

3(b) Richmond Southern Close
Lenie Adams Ave,
Richmond Park

Tel: +27 21 492 2000

Email: cape@acdc.co.za

PINETOWN

Unit 10, Pine Industrial Estate
Pineside Road, New Germany
Pinetown, Kwa-Zulu Natal

Tel: +27 31 700 4215

Fax: +27 31 700 4330

Email: kzn@acdc.co.za

RIVERHORSE

6 Riverhorse Close Riverhorse
Valley Business Estate,
Durban, Kwa-Zulu Natal

Tel: +27 31 492 4800

Fax: +27 87 405 0775

Email: rvh@acdc.co.za

FOLLOW US ON SOCIAL MEDIA



AC/DC SFC RHOMBERG



7th Edition August 2021

Specifications are subject to change from time to time, without notification in this publication.

© ACDC Dynamics 2021

NATIONAL CALL CENTRE

SALES - 010 202 3400 | TECHNICAL - 010 202 3500

