

# ACDC™

## DYNAMICS

[www.acdc.co.za](http://www.acdc.co.za)

*Solutions for all your Automation requirements*

### INDUSTRIAL AUTOMATION

*Everything under control!*



THINK ELECTRICAL





# WICK SELECTION GUIDE

## INDUCTIVE PROXIMITY SWITCHES - IP17

Type	M18		M12		M8		M6		M4		M3	
	Front	Back	Front	Back	Front	Back	Front	Back	Front	Back	Front	Back
Part No.	Part No.	Part No.	Part No.	Part No.	Part No.	Part No.	Part No.	Part No.	Part No.	Part No.	Part No.	Part No.
IP17M18-001	IP17M18-002	IP17M12-001	IP17M12-002	IP17M8-001	IP17M8-002	IP17M6-001	IP17M6-002	IP17M4-001	IP17M4-002	IP17M3-001	IP17M3-002	
IP17M18-003	IP17M18-004	IP17M12-003	IP17M12-004	IP17M8-003	IP17M8-004	IP17M6-003	IP17M6-004	IP17M4-003	IP17M4-004	IP17M3-003	IP17M3-004	
IP17M18-005	IP17M18-006	IP17M12-005	IP17M12-006	IP17M8-005	IP17M8-006	IP17M6-005	IP17M6-006	IP17M4-005	IP17M4-006	IP17M3-005	IP17M3-006	
IP17M18-007	IP17M18-008	IP17M12-007	IP17M12-008	IP17M8-007	IP17M8-008	IP17M6-007	IP17M6-008	IP17M4-007	IP17M4-008	IP17M3-007	IP17M3-008	
IP17M18-009	IP17M18-010	IP17M12-009	IP17M12-010	IP17M8-009	IP17M8-010	IP17M6-009	IP17M6-010	IP17M4-009	IP17M4-010	IP17M3-009	IP17M3-010	
IP17M18-011	IP17M18-012	IP17M12-011	IP17M12-012	IP17M8-011	IP17M8-012	IP17M6-011	IP17M6-012	IP17M4-011	IP17M4-012	IP17M3-011	IP17M3-012	
IP17M18-013	IP17M18-014	IP17M12-013	IP17M12-014	IP17M8-013	IP17M8-014	IP17M6-013	IP17M6-014	IP17M4-013	IP17M4-014	IP17M3-013	IP17M3-014	
IP17M18-015	IP17M18-016	IP17M12-015	IP17M12-016	IP17M8-015	IP17M8-016	IP17M6-015	IP17M6-016	IP17M4-015	IP17M4-016	IP17M3-015	IP17M3-016	
IP17M18-017	IP17M18-018	IP17M12-017	IP17M12-018	IP17M8-017	IP17M8-018	IP17M6-017	IP17M6-018	IP17M4-017	IP17M4-018	IP17M3-017	IP17M3-018	
IP17M18-019	IP17M18-020	IP17M12-019	IP17M12-020	IP17M8-019	IP17M8-020	IP17M6-019	IP17M6-020	IP17M4-019	IP17M4-020	IP17M3-019	IP17M3-020	
IP17M18-021	IP17M18-022	IP17M12-021	IP17M12-022	IP17M8-021	IP17M8-022	IP17M6-021	IP17M6-022	IP17M4-021	IP17M4-022	IP17M3-021	IP17M3-022	
IP17M18-023	IP17M18-024	IP17M12-023	IP17M12-024	IP17M8-023	IP17M8-024	IP17M6-023	IP17M6-024	IP17M4-023	IP17M4-024	IP17M3-023	IP17M3-024	
IP17M18-025	IP17M18-026	IP17M12-025	IP17M12-026	IP17M8-025	IP17M8-026	IP17M6-025	IP17M6-026	IP17M4-025	IP17M4-026	IP17M3-025	IP17M3-026	
IP17M18-027	IP17M18-028	IP17M12-027	IP17M12-028	IP17M8-027	IP17M8-028	IP17M6-027	IP17M6-028	IP17M4-027	IP17M4-028	IP17M3-027	IP17M3-028	
IP17M18-029	IP17M18-030	IP17M12-029	IP17M12-030	IP17M8-029	IP17M8-030	IP17M6-029	IP17M6-030	IP17M4-029	IP17M4-030	IP17M3-029	IP17M3-030	
IP17M18-031	IP17M18-032	IP17M12-031	IP17M12-032	IP17M8-031	IP17M8-032	IP17M6-031	IP17M6-032	IP17M4-031	IP17M4-032	IP17M3-031	IP17M3-032	
IP17M18-033	IP17M18-034	IP17M12-033	IP17M12-034	IP17M8-033	IP17M8-034	IP17M6-033	IP17M6-034	IP17M4-033	IP17M4-034	IP17M3-033	IP17M3-034	
IP17M18-035	IP17M18-036	IP17M12-035	IP17M12-036	IP17M8-035	IP17M8-036	IP17M6-035	IP17M6-036	IP17M4-035	IP17M4-036	IP17M3-035	IP17M3-036	
IP17M18-037	IP17M18-038	IP17M12-037	IP17M12-038	IP17M8-037	IP17M8-038	IP17M6-037	IP17M6-038	IP17M4-037	IP17M4-038	IP17M3-037	IP17M3-038	
IP17M18-039	IP17M18-040	IP17M12-039	IP17M12-040	IP17M8-039	IP17M8-040	IP17M6-039	IP17M6-040	IP17M4-039	IP17M4-040	IP17M3-039	IP17M3-040	
IP17M18-041	IP17M18-042	IP17M12-041	IP17M12-042	IP17M8-041	IP17M8-042	IP17M6-041	IP17M6-042	IP17M4-041	IP17M4-042	IP17M3-041	IP17M3-042	
IP17M18-043	IP17M18-044	IP17M12-043	IP17M12-044	IP17M8-043	IP17M8-044	IP17M6-043	IP17M6-044	IP17M4-043	IP17M4-044	IP17M3-043	IP17M3-044	
IP17M18-045	IP17M18-046	IP17M12-045	IP17M12-046	IP17M8-045	IP17M8-046	IP17M6-045	IP17M6-046	IP17M4-045	IP17M4-046	IP17M3-045	IP17M3-046	
IP17M18-047	IP17M18-048	IP17M12-047	IP17M12-048	IP17M8-047	IP17M8-048	IP17M6-047	IP17M6-048	IP17M4-047	IP17M4-048	IP17M3-047	IP17M3-048	
IP17M18-049	IP17M18-050	IP17M12-049	IP17M12-050	IP17M8-049	IP17M8-050	IP17M6-049	IP17M6-050	IP17M4-049	IP17M4-050	IP17M3-049	IP17M3-050	
IP17M18-051	IP17M18-052	IP17M12-051	IP17M12-052	IP17M8-051	IP17M8-052	IP17M6-051	IP17M6-052	IP17M4-051	IP17M4-052	IP17M3-051	IP17M3-052	
IP17M18-053	IP17M18-054	IP17M12-053	IP17M12-054	IP17M8-053	IP17M8-054	IP17M6-053	IP17M6-054	IP17M4-053	IP17M4-054	IP17M3-053	IP17M3-054	
IP17M18-055	IP17M18-056	IP17M12-055	IP17M12-056	IP17M8-055	IP17M8-056	IP17M6-055	IP17M6-056	IP17M4-055	IP17M4-056	IP17M3-055	IP17M3-056	
IP17M18-057	IP17M18-058	IP17M12-057	IP17M12-058	IP17M8-057	IP17M8-058	IP17M6-057	IP17M6-058	IP17M4-057	IP17M4-058	IP17M3-057	IP17M3-058	
IP17M18-059	IP17M18-060	IP17M12-059	IP17M12-060	IP17M8-059	IP17M8-060	IP17M6-059	IP17M6-060	IP17M4-059	IP17M4-060	IP17M3-059	IP17M3-060	
IP17M18-061	IP17M18-062	IP17M12-061	IP17M12-062	IP17M8-061	IP17M8-062	IP17M6-061	IP17M6-062	IP17M4-061	IP17M4-062	IP17M3-061	IP17M3-062	
IP17M18-063	IP17M18-064	IP17M12-063	IP17M12-064	IP17M8-063	IP17M8-064	IP17M6-063	IP17M6-064	IP17M4-063	IP17M4-064	IP17M3-063	IP17M3-064	
IP17M18-065	IP17M18-066	IP17M12-065	IP17M12-066	IP17M8-065	IP17M8-066	IP17M6-065	IP17M6-066	IP17M4-065	IP17M4-066	IP17M3-065	IP17M3-066	
IP17M18-067	IP17M18-068	IP17M12-067	IP17M12-068	IP17M8-067	IP17M8-068	IP17M6-067	IP17M6-068	IP17M4-067	IP17M4-068	IP17M3-067	IP17M3-068	
IP17M18-069	IP17M18-070	IP17M12-069	IP17M12-070	IP17M8-069	IP17M8-070	IP17M6-069	IP17M6-070	IP17M4-069	IP17M4-070	IP17M3-069	IP17M3-070	
IP17M18-071	IP17M18-072	IP17M12-071	IP17M12-072	IP17M8-071	IP17M8-072	IP17M6-071	IP17M6-072	IP17M4-071	IP17M4-072	IP17M3-071	IP17M3-072	
IP17M18-073	IP17M18-074	IP17M12-073	IP17M12-074	IP17M8-073	IP17M8-074	IP17M6-073	IP17M6-074	IP17M4-073	IP17M4-074	IP17M3-073	IP17M3-074	
IP17M18-075	IP17M18-076	IP17M12-075	IP17M12-076	IP17M8-075	IP17M8-076	IP17M6-075	IP17M6-076	IP17M4-075	IP17M4-076	IP17M3-075	IP17M3-076	
IP17M18-077	IP17M18-078	IP17M12-077	IP17M12-078	IP17M8-077	IP17M8-078	IP17M6-077	IP17M6-078	IP17M4-077	IP17M4-078	IP17M3-077	IP17M3-078	
IP17M18-079	IP17M18-080	IP17M12-079	IP17M12-080	IP17M8-079	IP17M8-080	IP17M6-079	IP17M6-080	IP17M4-079	IP17M4-080	IP17M3-079	IP17M3-080	
IP17M18-081	IP17M18-082	IP17M12-081	IP17M12-082	IP17M8-081	IP17M8-082	IP17M6-081	IP17M6-082	IP17M4-081	IP17M4-082	IP17M3-081	IP17M3-082	
IP17M18-083	IP17M18-084	IP17M12-083	IP17M12-084	IP17M8-083	IP17M8-084	IP17M6-083	IP17M6-084	IP17M4-083	IP17M4-084	IP17M3-083	IP17M3-084	
IP17M18-085	IP17M18-086	IP17M12-085	IP17M12-086	IP17M8-085	IP17M8-086	IP17M6-085	IP17M6-086	IP17M4-085	IP17M4-086	IP17M3-085	IP17M3-086	
IP17M18-087	IP17M18-088	IP17M12-087	IP17M12-088	IP17M8-087	IP17M8-088	IP17M6-087	IP17M6-088	IP17M4-087	IP17M4-088	IP17M3-087	IP17M3-088	
IP17M18-089	IP17M18-090	IP17M12-089	IP17M12-090	IP17M8-089	IP17M8-090	IP17M6-089	IP17M6-090	IP17M4-089	IP17M4-090	IP17M3-089	IP17M3-090	
IP17M18-091	IP17M18-092	IP17M12-091	IP17M12-092	IP17M8-091	IP17M8-092	IP17M6-091	IP17M6-092	IP17M4-091	IP17M4-092	IP17M3-091	IP17M3-092	
IP17M18-093	IP17M18-094	IP17M12-093	IP17M12-094	IP17M8-093	IP17M8-094	IP17M6-093	IP17M6-094	IP17M4-093	IP17M4-094	IP17M3-093	IP17M3-094	
IP17M18-095	IP17M18-096	IP17M12-095	IP17M12-096	IP17M8-095	IP17M8-096	IP17M6-095	IP17M6-096	IP17M4-095	IP17M4-096	IP17M3-095	IP17M3-096	
IP17M18-097	IP17M18-098	IP17M12-097	IP17M12-098	IP17M8-097	IP17M8-098	IP17M6-097	IP17M6-098	IP17M4-097	IP17M4-098	IP17M3-097	IP17M3-098	
IP17M18-099	IP17M18-100	IP17M12-099	IP17M12-100	IP17M8-099	IP17M8-100	IP17M6-099	IP17M6-100	IP17M4-099	IP17M4-100	IP17M3-099	IP17M3-100	

## COMPACTIVE SWITCHES (Table Units Only) - IP17

Type	M18		M12		M8		M6	
	Front	Back	Front	Back	Front	Back	Front	Back
Part No.	Part No.	Part No.	Part No.	Part No.	Part No.	Part No.	Part No.	Part No.
IP17C18-001	IP17C18-002	IP17C12-001	IP17C12-002	IP17C8-001	IP17C8-002	IP17C6-001	IP17C6-002	
IP17C18-003	IP17C18-004	IP17C12-003	IP17C12-004	IP17C8-003	IP17C8-004	IP17C6-003	IP17C6-004	
IP17C18-005	IP17C18-006	IP17C12-005	IP17C12-006	IP17C8-005	IP17C8-006	IP17C6-005	IP17C6-006	
IP17C18-007	IP17C18-008	IP17C12-007	IP17C12-008	IP17C8-007	IP17C8-008	IP17C6-007	IP17C6-008	
IP17C18-009	IP17C18-010	IP17C12-009	IP17C12-010	IP17C8-009	IP17C8-010	IP17C6-009	IP17C6-010	
IP17C18-011	IP17C18-012	IP17C12-011	IP17C12-012	IP17C8-011	IP17C8-012	IP17C6-011	IP17C6-012	
IP17C18-013	IP17C18-014	IP17C12-013	IP17C12-014	IP17C8-013	IP17C8-014	IP17C6-013	IP17C6-014	
IP17C18-015	IP17C18-016	IP17C12-015	IP17C12-016	IP17C8-015	IP17C8-016	IP17C6-015	IP17C6-016	
IP17C18-017	IP17C18-018	IP17C12-017	IP17C12-018	IP17C8-017	IP17C8-018	IP17C6-017	IP17C6-018	
IP17C18-019	IP17C18-020	IP17C12-019	IP17C12-020	IP17C8-019	IP17C8-020	IP17C6-019	IP17C6-020	
IP17C18-021	IP17C18-022	IP17C12-021	IP17C12-022	IP17C8-021	IP17C8-022	IP17C6-021	IP17C6-022	



# UNITRONICS PLC TRAINING



Book Today for 2020! Limited Seats Available



Discover how much more **UNITRONICS** can do for you!  
Discounts and specialised dates for 5 or more delegates from one company!  
Please note - Payment required with registration.

## GAUTENG TRAINING DATES

## COURSE PRICING - EX VAT

### VISIOLOGIC TRAINING

11 - 13 FEB | 21 - 23 APR | 9 - 11 JUN

### UNILOGIG TRAINING

10 - 12 MAR | 12 - 14 MAY | 14 - 16 JUL

VISIOLOGIC / UNILOGIC  
Training Tuition

**R4,450.<sup>00</sup>**

VISIOLOGIC TRAINING  
(With V350-J-TRA22 PLC)

**R14,466.<sup>80</sup>**

UNILOGIC TRAINING  
(With US5-B10-TA30 PLC)

**R21,615.<sup>36</sup>**

For more information e-mail: [FarrelS@acdc.co.za](mailto:FarrelS@acdc.co.za) or call 076 240 5504

#### HEAD OFFICE - JOHANNESBURG

P.O. Box 3812, Edenvale,  
1610, South Africa  
26 Nguni Drive  
Longmeadow Estate West  
Edenvale, Gauteng  
South Africa  
[info@acdc.co.za](mailto:info@acdc.co.za)  
Reception 010 202 3300  
Sales 010 202 3400  
Technical 010 202 3500  
Fax 010 202 3365  
[www.acdc.co.za](http://www.acdc.co.za)

#### BRANCH CONTACT DETAILS

Johannesburg 010 202 3300  
Germiston 011 418 9600  
Cape Town 021 510 0710  
Pinetown 031 700 4215  
Riverhorse 031 492 4800

THINK ELECTRICAL

follow us on     



# CONTENTS

## INSTRUMENTS & TELEMETRY



**4 - 9**  
PLC + HMI  
in one unit (OPLC)



**10, 11, 14**  
PLCs + Smart  
Relays



**10**  
Switched Mode  
Power Supplies



**12**  
HMI with I/O



**15-17**  
GSM Telemetry  
Controllers



**18**  
Stainless Steel Float  
Switches & Level Probes



**19**  
Probe, Rotary, Tuning Fork  
& Capacitive Level Switches



**20**  
Limit Level Sensors

## LEVEL CONTROL & PUMPS



**21 + 54**  
Analogue Ultrasonic  
Level Detection



**22**  
Hydrostatic Level  
Transmitters



**22**  
Thermal Dispersion  
Flow Switches

## LEVEL CONTROL & PUMPS



**25, 27**  
Square & Micro Inductive  
Proximity Switches



**26**  
Magnetic proximity  
Reed Switches



**25, 27, 28-33, 35**  
Inductive Proximity  
Switches



**28**  
Analogue Inductive  
Proximity switches

## LIMIT PRESSURE SWITCHES & SENSORS



**31 & 34**  
Capacitive Proximity  
Switches



**23, 24, 36-49**  
Photoelectric Sensors



**45, 50-51**  
Mark, Luminescence &  
Colour Sensors



**52**  
Laser Sensors



**53-54**  
Fork Sensors

## LIMIT PRESSURE SWITCHES & SENSORS



**55**  
Laser Distance  
Measurement Sensors



**56**  
Fibre Optic Sensors &  
Amplifiers

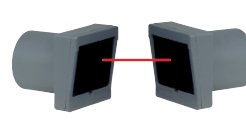

**57**  
Long Range Photo-  
electric Sensor Kits



**57-59**  
Rotary Encoders, Wheel  
Type Rotary Encoders



**59**  
Accessories for  
Rotary Encoders

## LIMIT PRESSURE SWITCHES & SENSORS



**60-62**  
Safety Light Curtains



**63**  
Safety Photo &  
Laser Sensors



**64-65**  
Safety Cables &  
Accessories



**66**  
Safety Control Relays  
& Connector Boxes



**67**  
Mobile Scanners & Vehicle  
Mount Computers

## LIMIT PRESSURE SWITCHES & SENSORS



**68**  
Area Light Grids



**68**  
Actuator Boxes,  
Cables & Connectors



**69**  
Cables & Accessories



**70-71**  
Sensor Cables  
& Connectors

## LIMIT PRESSURE SWITCHES & SENSORS

EXTENDED RANGE

# STAND ALONE PLC & UNISTREAM 5"



USC - With Virtual HMI Concept

Connect directly via Ethernet or USB, or use VNC to connect mobile phone, tablet or PC. Use your browser to surf to Unistream's built-in webserver



5"

Code	Inputs				Outputs				Operating Voltage
	Digital (Isolated)	HSC/Shaft-encoder <sup>1</sup>	Analog	Temperature inputs, RTD/TC	Transistor <sup>2</sup> (Isolated)	PWM <sup>2</sup>	Relay	Analog	
US5 <sup>^</sup> -B5-B1 US5 <sup>^</sup> -B10-B1*	-	-	-	-	-	-	-	-	12/24VDC
US5 <sup>^</sup> -B5-TR22 US5 <sup>^</sup> -B10-TR22*	10 Sink/Source	-	2 0-10V, 0-20mA, 4-20mA 12-bit	-	2 Sink (npn)	2 30kHz	8	-	24VDC
US5 <sup>^</sup> -B5-T24 US5 <sup>^</sup> -B10-T24*	10 Sink/Source	-	2 0-10V, 0-20mA, 4-20mA 12-bit	-	12 Source (npn)	2 3kHz	-	-	24VDC
US5 <sup>^</sup> -B5-RA28 US5 <sup>^</sup> -B10-RA28*	14 Sink/Source	2 90kHz 32-bit	2 (Isolated) 0-10V, 0-20mA, 4-20mA 14-bit	2 (Isolated) Thermocouple, PT100 / NI100 / NI120 / PT1000 / NI1000	-	-	8	2 0-10V 12-Bit ±10V 11-Bit + Sign	24VDC
US5 <sup>^</sup> -B5-TA30 US5 <sup>^</sup> -B10-TA30*	14 Sink/Source	2 90kHz 32-bit	2 (Isolated) 0-10V, 0-20mA, 4-20mA 14-bit	2 (Isolated) Thermocouple, PT100 / NI100 / NI120 / PT1000 / NI1000	10 Source (npn)	2 3kHz	-	2 0-10V 12-Bit ±10V 11-Bit + Sign 0-20mA, 4-20mA 12-Bit	24VDC
US5 <sup>^</sup> -B5-R38 US5 <sup>^</sup> -B10-R38	24 Sink/Source	4 90kHz 32-bit	2 0-10V, 0-20mA, 4-20mA 12-bit	-	-	-	12	-	24VDC
US5 <sup>^</sup> -B5-T42 US5 <sup>^</sup> -B10-T42	24 Sink/Source	4 90kHz 32-bit	2 0-10V, 0-20mA, 4-20mA 12-bit	-	16 Source (pnp)	2 3kHz	-	-	24VDC

<sup>1</sup> This module utilizes two high speed blocks that can each be assigned to the inputs or to the outputs

<sup>2</sup> Two outputs are high speed, up to 250KHz, and may function as normal or high-speed PWM outputs (same frequency and different duty cycles).

\* Note: 5" Pro versions include AudioJack, Webserver, Video, RTSP, and SQL Client

<sup>^</sup>For Stand Alone no HMI PLC replace 5 with C e.g. USC-B5-B1

## UNISTREAM COMMUNICATION MODULES

Unistream Models	Canbus Module	RS232 Module	2 x RS232	RS485 Module	1 x RS232 & 1 x RS485
Unistream 5"	<b>UAC-CX-01CAN</b>	<b>UAC-CX-01RS2</b>	-	<b>UAC-CX-01RS4</b>	-
Unistream 7, 10.4 & 15.6"	Incl in CPU <b>USC-P-B10</b>	<b>UAC-01RS2</b>	<b>UAC-02RS2</b>	-	<b>UAC-02RSC</b>

## UNISTREAM EXPANSION KITS SHORT & LONG RANGE

Code (7" - 15.6")	Description	Code (5")	Description
<b>UAG-XKP125</b>	Short Range Expansion Kit with embedded PSU, 125cm	<b>UAG-CX-XKP125</b>	UniStream CX IO Exp.Kit 125cm
<b>UAG-XKP300</b>	Short Range Expansion Kit with embedded PSU, 300cm	<b>UAG-CX-XKP300</b>	UniStream CX IO Exp.Kit 300cm
<b>UAG-XKPL1200</b>	Long range power supply expansion kit, 1200cm		

### UniLogic Top Features

- All-in-one Ergonomic Design** - Everything is visible
- Structs** - Tag Database on Steroids
- Speed Ladder Programming** - Plus "C" Power
- Power Data Tools** - Data Sampler, Data Tables, Recipes, \*SQL
- Web Server: Web pages** - No HTML Required
- Design Beautiful HMI Displays** - Stream Video, Audio, PDF
- Built-it-Once, then Reuse** - the Ultimate Time Saver
- Languages** - from Italian to Chinese at the touch of a button
- Built-in Alarms** - Easily Boost Application Safety
- Communications** - Configuration not Programming



UAG-XKP125

# UNISTREAM 7" - 15.6"



Code	HMI Panel	USP-070-B10	USP-104-B10	USP-156-B10
	CPU	USC-P-B10	USC-P-B10	USC-P-B10
Number of I/Os per CPU (On-board, local and remote)		Up to 2,048		
On-board Uni-I/O™ or Uni-COM Modules (All-in-one configuration)		Snap on up to 3 slim or 2 wide modules <sup>(1)</sup>	Snap on up to 5 slim or 3 wide modules <sup>(1)</sup>	
Local Uni-I/O™ Expansion		Use Local Expansion Adapters to add up to 80 slim modules or 50 wide modules <sup>(1)</sup>		
Remote I/O Expansion		Use EX-RC1 adapters to further extend the number of I/Os <sup>(4)</sup>		
Bit Operation		0.13 μs		
Ladder Memory		1 MB		
External Memory		microSD and USB Flash drive		
Video		Show MPEG-4 videos on the HMI screen		
Audio		Play MP3 audio files via internal speaker, or external speakers via audio-out jack		
Power Supply		12/24VDC		
Backup Battery		CR2032 Back-up RTC values, system data and retained tags		
<b>Communication</b>				
Ports		2 Ethernet • 1 RS485 • 1 CANbus 2 USB host ports • 1 USB device port for programming		
Protocols		MODBUS, EtherNet/IP™, CANopen, SNMP, FTP, BACnet(2), RTSP, VNC, UniCAN, GSM (SMS, GPRS), KNX, Message Composer for 3rd party protocols		

## UNISTREAM EXPANDIBILITY

Select the perfect combination of Uni-I/O™ modules and configure them to fit your application. Snap up to 5 modules onto a 10.4" or 15.6" HMI Panel, up to 3 onto a 7" panel. Expand further either locally or remotely.

**Notes:**

- This module utilizes two high speed blocks that can be assigned either to the inputs or to the outputs.
- 2 Outputs are high-speed, up to 250KHz: Function as normal or high speed PWM (same freq. and different duty cycles)
- Width: 1 'wide' I/O module = 1,5 'slim' I/O modules
- Note that the high-speed inputs are included in the total number of digital inputs
- Note that the high-speed outputs are included in the total number of digital outputs
- Not isolated

**See page 9 for Remote IO via Ethernet**



	Code	Inputs				Output			
		Digital (Isolated)	HSC/Shaft Encoder <sup>4</sup>	Analog	Temperature	Transistor <sup>5</sup> (Isolated)	PWM/HSO <sup>5</sup>	Relay	Analog
Digital	UID-1600	16 Sink/Source	-	-	-	-	-	-	-
	UID-0808T	8 Sink/Source	-	-	-	8 Sink/Source	-	-	-
	UID-W1616T <sup>3</sup>	16 Sink/Source	-	-	-	16 Sink/Source	-	-	-
	UID-0808THS <sup>1</sup>	8 Sink/Source	2. 250kHz 32-bit	-	-	8 Sink/Source	2. 250kHz, 2.3kHz <sup>2</sup>	-	-
	UID-0016T	-	-	-	-	16 Sink/Source	-	-	-
	UID-0808R	8 Sink/Source	-	-	-	-	-	8	-
	UID-W1616R <sup>3</sup>	16 Sink/Source	-	-	-	-	-	16	-
Analog & Temperature	UID-0016R	-	-	-	-	-	-	16	-
	UIA-0006	-	-	-	-	-	-	-	6
	UIA-0402N	-	-	4. 0-10V,0-20mA, 4-20mA. 13-bit	-	-	-	-	2
	UIA-0800N	-	-	8. 0-10V,0-20mA, 4-20mA. 13-bit	-	-	-	-	-
	UIS-04PTN	-	-	-	4. PT100/NI100/NI120	-	-	-	-
	UIS-04PTKN	-	-	-	4. PT1000/NI1000/NI1200	-	-	-	-
Digital, Analog & Temperature	UIS-08TC	-	-	-	8. Thermocouple	-	-	-	-
	UIS-WCB1 <sup>1,3</sup>	10 Sink/Source	2. 10kHz 32-bit	2. 0-10V,0-20mA, 4-20mA. 14-bit	2 (Isolated). PT100/NI100/NI120	2 Sink (NPN) <sup>6</sup>	-	8	2
	UIS-WCB2 <sup>1,3</sup>	10 Sink/Source	2. 10kHz 32-bit	2. 0-10V,0-20mA, 4-20mA. 14-bit	2 (Isolated). PT100/NI100/NI120	8 Source (PNP) 2 Sink (NPN) <sup>6</sup>	-	-	2



## VISION PLC AND HMI IN ONE UNIT IP65

**Vision** - Colour 3.5" Touchscreen & Vision 130 - Graphic 2.4" Display OPLC Series with expandable I/O - **Expandable up to 256 (V130)**  
Colour 4.3" Touchscreen - **Expandable up to 512 (V350/V430)**

**CE/UL** Standard Size (mm) 96 x 96 for V130 & V350 units

**Free Visilogic Ladder Software Including Programming Cable**

**Input/Output Cards for Testing**

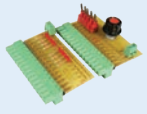

**Code V350-PC/SET**

**Vision 130/350/430 Features**

- HMI:**
- 1024 user designed screens & 250(V350)/400(V130) images per application
  - Built in alarm screens (V350)
  - Troubleshoot via the HMI, no PC needed
- PLC:**
- I/O options include high-speed, temperature & weight measurement
  - Expandable via IO cards
  - Recipe programs & data logging via Data tables
  - Micro SD card - log, backup, clone & more
  - **Communication:**
  - GPRS/GSM/CDMA enabled
  - TC/IP via Ethernet
  - Web server: view & edit PLC data via the Internet
  - SMS and e-mail function
  - MODBUS protocol
  - CANbus: CANopen, UniCAN SAE J1939 & more
  - Supplied with RS232/RS485 ports. 2 ports may be added: 1 Serial/Ethernet/Profibus & 1 CANbus



Code	V130-J-X	B1	TR20	R34	TR34	TR6	RA22	TRA22	T2	T38	TA24
	V350-J-X		RH2			RH6					
Inputs	Digital		12	22	22	8	12	12	12	22	12
	HSC/Shaft Encoder/max, Freq. Measurer		3.	3.	3.	1.	1.	1.	3.	2.	1.
	Analog		200kHz 32-bit	30kHz 32-bit	200kHz 32-bit	200kHz 32-bit	30kHz 32-bit	200kHz 32-bit	30kHz 32-bit	30kHz 32-bit	30kHz 32-bit
	NO onboard I/O's. HMI Only		2. 10-bit, 0-10V, 0-20mA, 4-20mA	2. 10-bit, 0-10V, 0-20mA, 4-20mA	2. 10-bit, 0-10V, 0-20mA, 4-20mA	2. 10-bit, 0-10V, 0-20mA, 4-20mA	2. 14-bit, 0-10V, 0-20mA, 4-20mA	2. (2 modes) Normal: 14-bit Fast: 12-bit 0-10V, 0-20mA, 4-20mA	2. 10-bit, 0-10V, 0-20mA, 4-20mA	2. 10-bit, 0-10V, 0-20mA, 4-20mA	2. (2 modes) Normal: 14-bit Fast: 12-bit 0-10V, 0-20mA, 4-20mA
Temperature Measurement			-	-	-	-	and as 2. PT100/TC	and as 2. PT100/TC	-	-	2. PT100/TC
Outputs	Relay PNP		6	12	8	6	8	4	-	-	-
	High-Speed Outputs/PWM		-	-	4 NPN, (3 PTO) 200Khz	-	-	4 PNP, (2 PTO) 200Khz	7	7	5
	Analog		2 NPN, (2 PTO) 200Khz	-	-	2 NPN, (2 PTO) 200Khz	-	0.5kHz	0.5kHz	0.5kHz	0.5kHz
	Power Supply		-	-	-	-	2. 12-bit 0-10V 4-20mA	2. 12-bit 0-10V 4-20mA	-	-	2. 12-bit 0-10V 4-20mA

\*12VDC available in V120 Range For Power Supplies see page 10

## SAMBA™ IP66

**Samba™** - Improve your competitive advantage. Great look incredible price - **Expandable via remote I/O's via CANbus**

**Free Visilogic Ladder Software Including Programming Cable**



- HMI:**
- 24 user-designed screens and 40 images per application
  - Built in alarm screens
  - Troubleshoot via the HMI panel, no PC needed
- PLC:**
- I/O options include: Digital, Analog and High speed
  - Auto-Tune PID, 2 independent loops
  - Recipe programs and data logging via Data Tables
  - **Communication:**
  - TCP/IP via Ethernet
  - Send e-mail function
  - SMS messaging
  - GPRS/GSM
  - MODBUS protocol support
  - CANbus: Canopen, UniCAN, SAE J1939 and more
  - 2 ports may be added: 1 Serial (RS232/RS485)/ Ethernet & 1 CANbus



Code	SM35-J-X SM43-J-X SM70-J-X	R20	T20	RA22	TA22
Inputs	Digital	10	10	10	10
	HSC/Shaft Encoder	1. 30kHz 32-bit 2. 10-bit	3. 30kHz 32-bit 2. 10-bit	1. 30kHz 32-bit 2. 12/14-bit	1. 30kHz 32-bit 2. 12/14-bit
	Analog	0-10v, 0-20mA, 4-20mA	0-10v, 0-20mA, 4-20mA	0-10v, 0-20mA, 4-20mA	0-10v, 0-20mA, 4-20mA
Temperature	-	-	2. PT100/TC	2. PT100/TC	
Outputs	Digital	8 Relay	8 PNP	8 Relay	8 PNP
	Analog	-	-	2. 12-bit 0-10v, 4-20mA	2. 12-bit 0-10v, 4-20mA
	High -Speed Outputs/PWM	-	Outputs 0-7 can be used as PWM outputs 0.5kHz	-	Outputs 0-5 can be used as PWM outputs 0.5kHz
	Power Supply	24VDC			

INSTRUMENTS & TELEMETRY

# VISION COLOUR GRAPHIC TOUCH OPLC

## Vision Series Advanced Colour, Graphic and Touch OPLC's 12/24VDC

- Vision 1210/1040 with an integrated colour touchscreen. Snap in and expansion I/O's up to 1000
- Vision 570 with an integrated 5.7" colour touchscreen. Snap in and expansion I/O's up to 1000
- Vision 230/280 with an integrated Operator Panel (Graphic or Touch). Snap in and expansion I/O's up to 316



Free Visilogic Ladder Software

Mono Graphics ↓ ↓

### Vision 1210/1040/570 Features

- HMI:**
- Up to 1024 user designed screens
  - 500 images per application
  - Built in alarm screens
  - Troubleshoot via the HMI, no PC needed
- PLC:**
- I/O options include high-speed, temperature & weight measurement
  - Auto-tune PID, up to 24 independent loops
  - Recipe programs & data logging via Data tables
  - Micro SD card - log, backup, clone & more
- Communication:**
- GPRS/GSM/CDMA enabled
  - TCP/IP via Ethernet
  - SMS and e-mail function
  - MODBUS protocol
  - CANbus: CANopen, UniCAN, SAE J1939 & more
  - Supplied with 2 isolated RS232/RS485 and 1 CANbus, **1 USB programming port\***, 1 port may be added for serial/Ethernet



Code	V1210-T20BJ	V1040-T20B	V700-T20BJ	V570-57-T20B-J	V560-T25B	V280-18-B20B
<b>Operator Panel</b>						
Display Size	12.1"	10.4"	7"	5.7"		4.7"
Type	TFT LCD					B&W FSTN LCD
Touch Screen	Resistive Analogue					
<b>Keyboard</b>						
Number of keys	Virtual Keypad	9 Programmable Function keys	Virtual keyboard	Virtual keyboard	24 Programmable Function keys	27 user labelled keys
<b>I/O Options</b>						
Snap-in I/O Modules	Snap onto the back of the Vision units to create a self-contained PLC with up to 62 I/O Local or remote I/O's					
I/O Expansion	Local or Remote may be added via expansion port or via CANbus					
<b>Program</b>						
Application Memory	Application Logic: 2MB Images: 80MB Fonts: 1MB		Application Logic: 2MB Images: 40MB Fonts: 1MB		Application Logic: 2MB Images: 12MB Fonts: 1MB	
SD Card (Micro)	Storage Datalogs, Alarm History, Data Tables, Trend data, Export to excel. Clone PLC's					-

For Power Supplies see page 10. \*Only applicable for V1210, V1040 & V570

# SNAP-IN I/O MODULES FOR VISION SERIES IP20

## "Snap-In" I/O Modules

- Plug a Snap-In Module Directly into the back of a Vision PLC. Compatible with all V200, V500, V1040 and V1210 Vision Series Models

## Example of "Snap-In" Module



## "Snap-In" Module



Code	Input			Output			
	Digital NPN/PNP	Analog	Temperature Measurement	Digital	Relay	Analogue	
V200-18-E1B	Including 2 Shaft Encoder Inputs	3. 10-bit 0-10v, 0-20mA 4-20mA	-	4 NPN/PNP (including 2 high-speed outputs)	10	-	
V200-18-E2B		2. 10-bit 0-10v, 0-20mA 4-20mA	-			2. 12-bit 0-10v, 0-20mA 4-20mA	
V200-18-E3XB		Including 2 Shaft Encoder Inputs	4. isolated 12-bit 0-10v, 0-20mA 4-20mA	4 TC/PT100	2 NPN/PNP high-speed	15	4. 12-bit 0-10v, 4-20mA isolated
V200-18-E4XB							
V200-18-E5B		18	3. 10-bit 0-10v, 0-20mA 4-20mA	-	-	-	-
V200-18-E6B		Including 2 Shaft Encoder Inputs	3. 10-bit 0-10v, 0-20mA 4-20mA & 2. 14-bit 0-10v, 0-20mA 4-20mA	2 TC/PT100	2 NPN/PNP high-speed	15	2. 12-bit 0-10v, 4-20mA isolated
V200-18-E46B			18				
V200-18-E62B	30		2. 10-bit 0-10v, 0-20mA 4-20mA	-	28 PNP 2 NPN/PNP High-speed	-	-

## M91 PLC & HMI IN ONE UNIT IP65

M91 Palm size PLC and textual HMI with up to 38 onboard I/O's - Expandable up to 150

**Free U90 Ladder Software**

Training courses available for all Unitronics PLC's

**M91 Features**

- HMI:**
- Up to 80 user-designed screens
  - Multilingual: supports over 15 languages & 20 graphic symbols
  - Scroll between pre-programmed recipes/menus
  - Troubleshoot via the HMI, no PC needed
- PLC:**
- Shaft-Encoder inputs and PWM outputs
  - Direct temperature inputs
  - Database
  - Auto-tune PID, up to 4 loops
- Communication:**
- SMS messaging via GSM
  - PC access via MODBUS or OPC server. MODBUS networking
  - CANbus (on C Models)
  - RS232/RS485 built in port



Code	M91-2-R1	M91-2-R2C	M91-2-R6C	M91-2-R34	M91-2-T1	M91-2-T38	M91-2-T2C	M91-2-UA2	M91-2-RA22
<b>Inputs</b>	Digital PNP/NPN	10	10	6	22	12	22	12	12
	HSC/Shaft	3.	3.	1.	3.	2.	2.	3.	1.
	Encoder/max, Freq. Measurer	10kHz	10kHz	10kHz	30kHz	10kHz	30kHz	10kHz	30kHz
	Analog	16-bit	16-bit	16-bit	16-bit	16-bit	16-bit	16-bit	16-bit
<b>Outputs</b>	Digital	1. 10-bit 0-10V, 0-20mA, 4-20mA	2. 10-bit 0-10V, 0-20mA, 4-20mA	6. 10-bit 2. 0-10V, 0-20mA, 4-20mA and 4. 0-20mA, 4-20mA	2. 10-bit 0-10V, 0-20mA, 4-20mA	-	2. 10-bit 0-10V, 0-20mA, 4-20mA	2. 14-bit 0-10V, 0-20mA, 4-20mA	2. 14-bit 0-10V, 0-20mA, 4-20mA
	Temperature Measurement	-						2 TC	2
	High-Speed/PWM	6 Relay			12 Relay	12 PNP	16 PNP	12 PNP	10 PNP
	Analog	-			-	2, first 2 outputs can function as HSO, 0.5kHz max			-
Power Supply	12/24VDC		24VDC		12/24VDC	24VDC	12/24VDC	24VDC	12/24VDC

## JAZZ<sup>®</sup> MICRO OPLC<sup>™</sup> IP65

New Jazz 2 Series. Much more than a "smart relay"  
Full function PLC & HMI with up to 40 onboard I/O's - **Non Expandable**

**Free U90 Ladder Software**

**Jazz Features**

- HMI:**
- Up to 60 user-designed screen
  - Multilingual: supports over 15 languages & 20 graphic symbols
  - Scroll between pre-programmed recipes/menus
- PLC:**
- Ladder Logic Programming
  - Functions include: interrupt, loops, maths, store & compare functions
  - High-speed counters & PWM outputs
  - Direct temperature inputs
  - Auto-tune PID, up to 4 loops
- Communication:**
- SMS messaging via GSM
  - PC access via MODBUS or OPC server. MODBUS networking



Jazz-J Flat Panel



JAZZ-PC/SET

**Accessories**

**Ethernet Comm. Port**



**MJ20-ET1**  
Ethernet add on port supported by Jazz 2 series only

**COM Port Kit**



**JZ-RS4**  
RS232/RS485 Add-on port (isolated)

**Program Cloner Module**



**MJ20-MEM1**  
Copy applications from PLC to PLC

**USB Cable**



**USB - CAB200**  
USB Programming Cable

Classic Code	JZ20-R10	JZ20-R16	JZ20-R31	JZ20-T10	JZ20-T18	JZ10-11-T40	JZ10-11-UN20	JZ10-11-UA24	JZ10-11-PT15	
Flat Code	JZ20-J-R10	JZ20-J-R16	JZ20-J-R31	JZ20-J-T10	JZ20-J-T18	JZ10-J-T40	JZ10-J-UN20	JZ10-J-UA24	JZ10-J-PT15	
<b>Inputs</b>	Digital PNP/NPN	6	8	18	6	8	18	11	6	
	High-S Counter	2. 10kHz, 16-bit					1. 5kHz, 16-bit			
	Analog	-	2. 10 or 12-bit, 0-10V & 2. 10-bit, 0-20mA, 4-20mA		-	2. 10-bit, 0-10V & 2. 10-bit, 0-20mA, 4-20mA		2. 10-bit 0-20mA, 4-20mA	1. 10-bit 0-20mA, 4-20mA	3. 10-bit 0-10V
	Temperature Measurement	-						1 PT100/TC	2 PT100/TC	3 PT1000/ NI1000
<b>Outputs</b>	Digital	4 Relay	6 Relay	11 Relay	4 PNP	8 PNP	20 PNP	5 Relay, 2 PNP	5 Relay 1 PNP/NPN	
	High-Speed/PWM	-			2 PMW				1 HSO	
	Analog	-			-				2. 12-bit 10V,4-20mA	
	Power Supply	24VDC								



## I/O EXPANSION CARDS

### High-Speed Remote I/O Module

Code	Description
<b>EXF-RC15</b>	<b>9 Digital Inputs PNP/NPN</b> , including 3 high-speed counter, <b>4 NPN Transistor Outputs</b> , may function as high-speed PWM/PTO, <b>2 relay outputs</b> .



**Note:** Expand your system with local or remote I/O expansion modules. Vision series support both local & remote I/O modules. M91 support local module only  
**Note:** 12VDC I/O modules also available

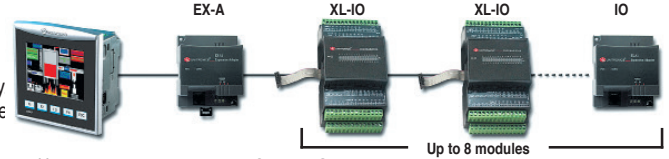

\* Including up to 1 High Speed Counter. \*\* Including up to 2 High Speed Counter  
 \*\*\* EX90 is housed in an open casing. Only one EX90 can be connected per PLC, as a single expansion module

### I/O Expansion Module Adaptors

Code	Description
<b>EX-A2X</b>	Local I/O module adaptor. Galvanic isolation. Connect up to 8 modules per adaptor. 12/24VDC.
<b>EX-RC1</b>	Remote I/O module adaptor via CANbus. Multiple adaptors can be connected to a single PLC. Connect up to 8 modules per adaptor. 12/24VDC.



### Temperature and Weight/Strain Measurements

Code	Description
<b>IO-PT400</b>	<b>4 PT100/Ni100/Ni120 Inputs</b> Range: PT100 (-50° to 460°) Range: Ni100 (-50° to 232°) Range: Ni120 (-50° to 172°) 12-bit
<b>IO-PT4K</b>	<b>4 PT1000/Ni1000 Inputs</b> Range PT000 (-50° to 460°) Range Ni1000 (-50° to 232°) 12-bit
<b>IO-ATC8</b>	<b>8 Thermocouple / Analogue Inputs</b> , T/C, J, K, T, B, E, N, R, S. 0-10v, 0-20mA, 4-20mA. 12/14-bit
<b>IO-LC1 and IO-LC3</b>	<b>1-3 Loadcell / Strain gauge Inputs</b> Input voltage ranges: ± 20mV, ± 80mV Excitation: AC/DC, <b>1 Digital PNP Input, 2 Setpoint PNP Outputs</b>

Code	Digital & Analogue Modules	Input			Output		
		Digital PNP/NPN	Analog	AC 110/220V	Digital PNP	Relay	Analog
I/O	<b>IO-DI8-TO18</b>	8*	-	-	8	-	-
	<b>IO-DI8-RO4</b>	8*	-	-	-	4	-
	<b>IO-DI8-RO8</b>	8*	-	-	-	8	-
	<b>IO-DI16</b>	16*	-	-	-	-	-
	<b>IO-RO8</b>	-	-	-	-	8	-
	<b>IO-RO16</b>	-	-	-	-	16	-
	<b>IO-TO16</b>	-	-	-	16	-	-
	<b>IO-DI8ACH</b>	-	-	8	-	-	-
	<b>IO-D16A3-RO16</b>	16**	3. 10-bit 0-20mA or 4-20mA	-	-	16	-
	<b>IO-D16A3-TO16</b>	16**	3. 10-bit 0-20mA or 4-20mA	-	15+1 PNP/NPN or HSO	-	-
I/O with Expansion Adaptor	<b>IO-AI4-AO2</b>	-	4. 12-bit 0-10V 0-20mA or 4-20mA	-	-	-	2. 0-10V 0-20mA 4-20mA 12-bit
	<b>IO-AI8</b>	-	8. 0-10V or 14-bit 0-20mA	-	-	-	-
	<b>IO-AO6X</b>	-	-	-	-	-	6. Isolated, 0-10V, 0-20mA, 4-20mA, 12-bit
	<b>EX-D16A3-R08</b>	16**	3. 10-bit 0-20mA or 4-20mA	-	-	8	-
	<b>EX-D16A3-TO16</b>	16**	3. 10-bit 0-20mA or 4-20mA	-	15+1 PNP/NPN or HSO	-	-
	<b>EX90-DI8-RO8***</b>	8*	-	-	-	8	-

## COMMUNICATION MODULES

Vision Model	Ethernet	RS232/RS485	Isolated RS232/RS485	CANbus	Profibus
V130, V350, V430, Samba	<b>V100-17-ET2</b>	<b>V100-17-RS4</b>	<b>V100-17-RS4X</b>	<b>V100-17-CAN</b>	<b>V100-17-PB1</b> (Not V430)
V200, V500, V1040, V1210	<b>V200-19-ET2</b>	<b>V200-19-RS4</b>	<b>V200-19-RS4X</b>	-	-

NEW

## UNISTREAM REMOTE IO OVER ETHERNET

### Unistream Remote IO Over Ethernet



URB-TCP

Code	Description
<b>URB-TCP</b>	Remote IO Ethernet Adapter
<b>URB-0800</b>	8 Digital Inputs (Sink/Source) 24VDC
<b>URD-1600-8</b>	16 Digital Inputs (Sink/Source) 24VDC
<b>URD-3200-4</b>	32 Digital Inputs (Sink/Source) 24VDC
<b>URD-0200E</b>	2 High Speed Counter/Encoder In 24VDC
<b>URD-0008C*H</b>	8 Digital Outputs (Source) 24VDC/0.5A
<b>URD-0016C*G-8</b>	16 Digital Outputs (Source) 24VDC/0.3A
<b>URA-0400T^</b>	4 Analog Current Inputs 16 Bit
<b>URA-1600T^~8</b>	16 Analog Current Inputs 16 Bit
<b>URA-0004Y</b>	4 Analog Current Outputs 16 Bit
<b>URA-0004Z</b>	16 Analog Voltage Outputs 16 Bit
<b>URS-04RT</b>	4 RTD/Resistance
<b>URS-04TC</b>	4 Thermocouple / mV
<b>URS-08TC-2</b>	8 Thermocouple / mV

\* For Sink type replace C with N e.g. URD-0008NH ^ For Voltage type replace T with U e.g. URA-0400U

## SMART RELAY GENIE™ -NX

	Genie-NX Base Module		Comms Module		Expansion Module	
 48 I/O Max						
Code	G7DDT9	G8DDT9	G7XDTR4	G8XDTR4	G7DDT6E	G8DDT6E
General						
Supply Voltage	110-240VAC	12-24VDC	110-240VAC	12-24VDC	110-240VAC	12-24VDC
Size W x H x D	72 x 90 x 65 mm		36 x 90 x 60 mm		72 x 90 x 65 mm	
Mounting	Base/DIN Mount		Base/DIN Mount		Base/DIN Mount	
Reserve (Clock)	150h at -10°C to 55°C		-		-	
I/O's						
Max Exp. Modules	3 x Expansion Modules		-		-	
Digital Input	8 (0-50VAC) Off, (80-265VAC) On	6 (0-4VDC) Off, (8-26.4VDC) On	TTL Level 1		8 (0-50VAC) Off, (80-265VAC) On	8 (0-4VDC) Off, (8-26.4VDC) On
Analogue Input	N/A	2 (can be used for Analogue)	-		-	
Output	-		RS485 Protocol (2 Wires, D+, D-)		-	
Relay Output	4 x NO 8A	4 x NO 8A	-		4 x NO 8A	4 x NO 5A
Communication						
RS 485 PROTOCOL	-		RS485 (2 Wires, D+, D-)		<b>Accessories</b>  GFDNN1 GFDNN2S GFDNN3M	
Modbus Comms	-		YES (RTU)(SLAVE)			
DST	-		-			
LED Indication	-		Red LED's for Tx & Rx. Green LED for Power			
Number of Nodes	-		32 std Unit Loads			
Baud Rate	-		300, 600, 1200, 2400, 4800, 9600			
Programming						
Ladder Programming	250 Lines					
Function Blocks						
Timers	16 (on delay, interval, cyclic, on-off, off delay)					
Counters	16 (Up/Down, Retentive selectable)					
Time Switches	16 (Weekly/Daily)					
Compare Counters	16					
Analogue Functions						
Soft Text Messages	N/A 16 (Priority Driven) 12					
AUX Relays	64					
			Code	Description	Code	Description
			GFDNN3M	Memory Card	GFDNN1	USB Cable
			GFDNN2S	RS 232 Serial Communication Cable	GNXNN1	GENIE NX Software Windows 98, 2000, XP, Vista & Windows
			Features			
			<ul style="list-style-type: none"> <li>• Supports up to 32 Digital Inputs &amp; 16 Digital Outputs</li> <li>• 250 lines of ladder programming</li> <li>• 16 Messages, Time Switches, Compare Counters, Timers, Counters &amp; (12 analogue functions - G8DDT9 only)</li> <li>• DST Feature available</li> <li>• PC software for programming, online &amp; offline simulation, documentation &amp; printing</li> </ul>			

## SWITCHED MODE POWER SUPPLIES

	24AS Series		24BS Series		24BS051D1F
Code	24AS244D6D	24AS126D6D	24BS24AD4E	24BS241D2F	24BS051D1F
Supply Voltage	230V, 50Hz	230V, 50Hz	100-240V, 50/60Hz	100-240V, 50/60Hz	100-240V, 50/60Hz
Output Voltage	24VDC	12VDC	24VDC	24VDC	5VDC
Rated Current	5A	6A	2.5A	1A	1A
Accuracy	±1%	±1%	±1%	±1%	±1%
Line/Load Regulation	1%	1%	1%	1%	1%
Ripple, Noise	150mV (P-P)	100mV (P-P)	150mV (P-P)	150mV (P-P)	100mV (P-P)
Overvoltage Protection	26-33V	13-16V	160% of Full Load	160% of Full Load	180% of Full Load
Overload Capacity	168% for 10s Max	130% for 10s Max	150-250% for 5s Max	120-175% for 5s Max	120-140% for 5s Max
Dimensions	108 x 90 x 58mm	108 x 90 x 58mm	72 x 90 x 58mm	36 x 90 x 60mm	48 x 90 x 58mm

# PL-100 MINI PROGRAMMABLE LOGIC CONTROLLER

## PL-100 Base Module

## Expansion Module



Code	PC10161D1	PC10142D1	Code	Description	DIN Width
<b>General Specifications</b>			<b>EDCI8</b>	8 Digital Inputs	2MOD.
Voltage	24VDC		<b>EDCRO8</b>	8 Relay Outputs	2MOD.
Internal Current Consumption	65mA @ 24VDC	60mA @ 24VDC	<b>EDCI8RO8</b>	8 Digital Inputs and 8 Relay Outputs	4MOD.
Inrush Current	2.5A @VDC		<b>EDCTLO8</b>	8 Transistor Low Side Outputs	2MOD.
Battery Backup	30 Days		<b>EDCTHO8</b>	8 Transistor High Side Outputs	2MOD.
Separate Power Supply for Outputs	Not Required	19.2 - 26.4VDC	<b>EANIV4C4</b>	4 Analog Inputs (0-10v / 4-20mA)	2MOD.
DIN Width	4MOD.	4MOD.	<b>EANOV2C2</b>	2 Analog Outputs (0-10V / 4-20mA)	2MOD.
Max No of I/O's	100				
Max No of Expansion Modules	6				
<b>I/O's - Onboard</b>					
Digital Inputs	8 (Sinking / Sourcing)	6 + 2 High Speed	<b>Accessories</b>		
Input voltage Range	0 - 26.4VDC		<b>Code</b>	<b>Description</b>	
Level (Logic 0)	Max 7VDC		<b>28D33B0</b>	USB Cable	
Level (Logic 1)	Min 16VDC		<b>PC10AC2</b>	RS232 Communication Cable PLC- HMI / SCADA	
Input Current	1.2mA Max Per Unit		<b>PC10AC3</b>	RS485 Communication Cable PLC- HMI / SCADA	
Input Frequency	10Hz Max		<b>PL-SOFT</b>	Programming Software Windows 98, 2000, XP, 7, 8, Vista	
Digital Outputs	8Relay (NO)	4 + 2 High Speed MOSFET Low Side Driver			
Rated Load	5A @ 230VAC / 30VDC	24VDC 500mA			
Max Load Per Common	10A	-			

### Communications, Features & Benefits

- PC Port - USB (Type B)
- HMI Port (RS232 / RS485) - RJ11 (for HMI or any MODbus Device)
- Communication Parameters - Software Selectable
- HMI Port Comm. Protocol - MODbus Master/Slave
- Supports up to 100 I/O's
- Relay Base & MOSFET Low Side Base Modules
- Stacking using FRC cable. Max 6 Expansion Modules
- Isolated Digital Inputs with Sourcing & Sinking
- Isolated Digital Transistorized Outputs
- High Speed Inputs - Single / Quadrature
- Programming Language: Ladder
- High Speed Outputs (PTO / PWM / S-Profile)
- Analogue Inputs & Outputs 0-10v / 4-20mA
- Online & Offline Simulation
- Standard RS232/RS485 Port with RJ11 for HMI / SCADA Interface
- MODbus RTU Support
- 128 Weekly, Monthly & Yearly Time Switches
- Multiple Timers, Counters. Hour meters and many more function blocks

# COMMUNICATION ACCESSORIES AND PROTOCOL CONVERTERS

<p>40B2BAVAA</p>	<b>GSM Alarm Modem</b>		<b>Lynx Gateway</b>		
	<b>Code</b>	<b>Description</b>	<b>Code</b>	<b>25A11A0</b>	<b>25B11A0</b>
	<b>40B2BAVAA</b>	24VDC GSM Modem for Mini PLC PL-100. Includes wire type antenna. Remote Control, monitoring and diagnostics for digital and analog inputs and outputs through SMS messages to and from the GSM modem	<b>General Specifications</b>		
			Supply Voltage	12-24VDC	
<p>28A11A0</p>	<b>USB to Serial Converter</b>		Protocol Conversion	Modbus RTU/ASCII to Modbus TCP	Serial to Ethernet
	<b>28A11A0</b>	This converter converts RS232/RS485/RS422 to USB. Includes 1.5kV Galvanic isolation between USB and Serial ports.	Operation Mode	Modbus RTU / ASCII (Master Slave), Modbus TCP (Server / Client)	Raw Telnet
	<b>28NNN10</b>	Software CD for Win XP, Vista, Win7, Win8	Config Management	HTTP Web Server & Appl. Software	
<p>26A11AV</p>	<b>GSM Controller - Control by Missed call, SMS, IVRS call</b>		<b>Serial Interface</b>		
	<b>26A11AV</b>	180 - 500VAC 3 Phase for remote monitoring and ON/OFF switching of various electrical loads using mobile handsets	# of serial Ports	1	2
	<b>26A21AV</b>	85 - 265VAC 1 Phase for remote monitoring and ON/OFF switching of various electrical loads using mobile handsets	Serial Interface: Port 1	Screw Term for RS232, RS422, RS485	
	<b>26100V0</b>	Wire type antenna	Port 2	-	RJ11 for RS232
<p>25A11A0</p>			<b>Serial Interface</b>		
			Port	RJ45, Ethernet 10/100 Mbps	
		Network Protocols for coms	TCP/IP, Modbus	Raw, Telnet	



# PROFESSIONAL OPERATION PANEL WITH I/O

- User Friendly Script Language
- High memory and storage capacity
- Project download and upload via USB
- Industry Standard communication networks
- Font support for FreeType and Windows

- **Communication Protocols:** Modbus, ASCII, RTU, TCP/IP, MODBUS TCP, UDP, SNMP
- **Siemens S7:** 300/400/1200/1500 PLC Protocol Support
- **USB:** 1xUSB 2.0 (Client), 1xUSB 2.0 (Host)
- **Serial Ports:** 1 x RS485 (Terminal), 1 x RS232 (Terminal), 1 x RS232 (DB-9)
- **Ethernet:** 1 x 10/100 Mbps
- **Power supply:** 18-30VDC
- **MCU** ARM Cortex-A7, 528Mhz. ARM Cortex-A9, 800Mhz
- **Flash Memory:** 4 GB
- **Ram:** 512 MB DDR3 SDRAM
- **Battery:** CR2032 button cell lithium 3V (removable) with 5 years life

### 7" Series

Free Proop Builder Software

### 10" Series

Free Proop Builder Software

Code	Light	Control	Light	Control	Process
	PROOP-7LE	PROOP-7CE	PROOP-10LE	PROOP-10CE	PROOP-10PE
<b>Specifications:</b>					
Digital Inputs	-	4	-	5	5
Digital Outputs	-	4	-	4	4
Analog In 4-20mA	-	-	-	-	2
Analog Out 4-20mA	-	-	-	-	2

### Din Rail I/O Expansion Modules

Code	Description
IO-P2213	8 Digital In/ 8 Digital Out
IO-P221311	8 Digital In/ 5 PT100/ 8 Digital Out/ 2 Analog Out 0/4-20mA
IO-P221312	8 Digital In/ 5 PT100/ 8 Digital Out/ 2 Analog Out 0-10Vdc
IO-P221321	8 Digital In/ 5 Analog In 0/4-20mA/ 8 Digital Out/ 2 Analog Out 0/4-20mA
IO-P221332	8 Digital In/ 5 Analog In 0-10Vdc/ 8 Digital Out/ 2 Analog Out 0-10Vdc
IO-P221341	8 Digital In/ 5 Analog In 0-50mV/ 8 Digital Out/ 2 Analog Out 0/4-20mA
IO-P221342	8 Digital In/ 5 Analog In 0-50mV/ 8 Digital Out/ 2 Analog Out 0-10Vdc
28D33BO	USB Programming Cable

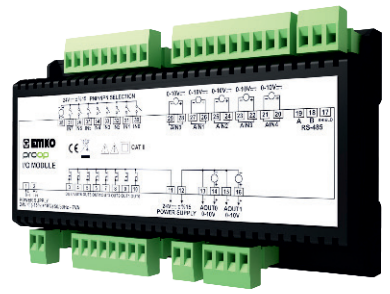

I/O Expansion Card

- All the above I/O cards use RS485 Communication and require 24VAC/DC Power Supply • GSM Units available on request
- PT100 range: -200 to 650°C. • Analog inputs: 14-Bit. • Analog Outputs = 12-Bit • Connect up to 32 I/O Expansion Modules

# POULTRY AUTOMATION AND CONTROL SYSTEMS

- Emko Cloud Web Management
- Multiple Poultry Visualisations
- Remote Monitoring and Control for Android and IOS
- Alarm SMS's

- **Power Supply:** 24VDC
- **CPU:** ARM Cortex-A9, 800Mhz
- **RAM:** 512MB
- **Flash Memory:** 4GB
- **Ethernet:** 1 x 10/100 Mbps
- **Battery:** CR2032 button cell lithium 3V (removable) with 5 years life

### 10" HMI Touch Panel

### I/O Expansion Modules

### GSM SMS Module

### RS485 Humidity and Temp. Sensor

Code	EPC-T10	EPC-N-IO	EPC-N-GSM	PMD-W-O/O-110
<b>Specifications:</b>	2 x USB 1 x Ethernet 1 x RS232 (For GSM Module) 1 x RS485 (I/O card) Com Port	8 Digital Inputs 18 Relay Outputs 11 Analogue Inputs 2 Analogue Outputs 2 x RS485 Com Ports (For I/O communication)	GSM SMS Module Antenna + 3m Communication Cable	Wall Mounting Humidity and Temperature Sensor RS485 Communication Temp: -20 to 80°C Humidity: 0 - 100% RH

INSTRUMENTS & TELEMETRY

# CHICKEN FARM LIGHTING SYSTEM

LIT

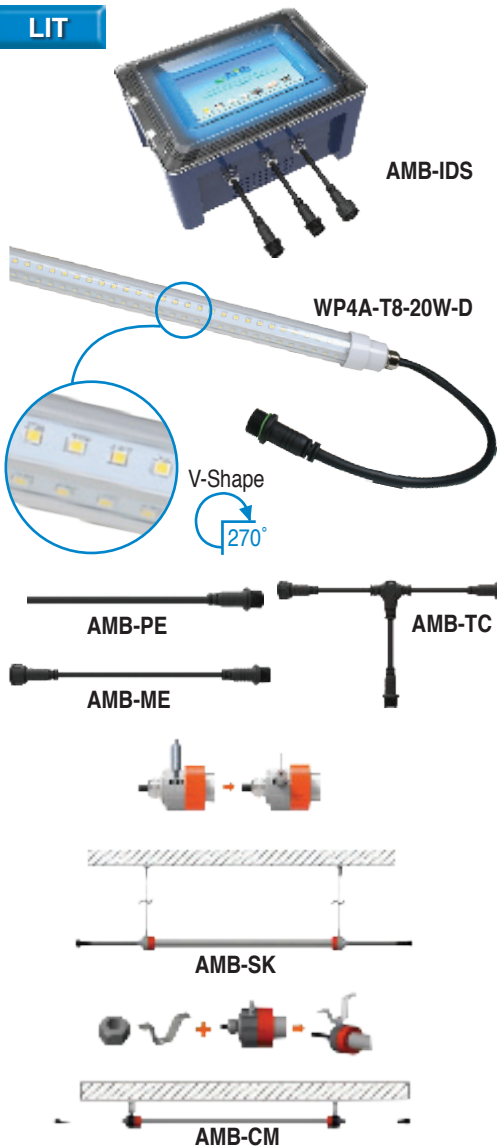

**Programmable Dimmer & Timer** - Input Voltage: 230VAC | **IP66** | Support DIY Programming | Auto-Programmable operation setting modes in 24hr cycles | Built-in digital CPU with smart control performance | Leading Edge & Trailing Edge dimmable | 0%-100% Dimmable, dimming precision 1% simulate sunrise - sunset | 7 inch LCD | Easy replacement for traditional lamps, no need to rewire the old existing cable

Code	Output Current
AMB-IDS-2000W	1 x 10A
AMB-IDS-4000W	2 x 10A

**A Series - White End Caps / Triac Dimmable** - Input Voltage: 230VAC | **IP65** | V-Shape 270° | CRI > 80 | L80B50 70 000hrs | Full spectrum | Dimming from 0.2% - 100% without flicker to simulate sunrise to sunset | Compatible with intelligent dimmer & timer system | Humidity proof, dust proof, shatter proof | 300mm male and female connector for series connection | Anti-ammonic and acid for poultry industrial lighting | To be used with **AMB-IDS** controller

Code Triac	Wattage	Lumens	Length (mm)
WP4A-T8-20W-D*	20W	2400lm	1200 x 28
WP5A-T8-24W-D*	24W	2880lm	1500 x 28
WP6A-T8-28W-D*	28W	3360lm	1800 x 28

\* Add Colour Temperature to Code: ○ **WW** (3000K), ○ **CW** (4200K), ○ **DL** (5000K)

**A Series - White End Caps / 0-10V Dimmable** - Input Voltage: 230VAC | **IP65** | V-Shape 270° | CRI > 80 | L80B50 70 000hrs | Full spectrum | Dimming from 3% - 100% without flicker to simulate sunrise to sunset | Humidity proof, dust proof, shatter proof | 300mm male and female connector | Anti-ammonic and acid for poultry industrial lighting | To be used on existing poultry controllers, not compatible with **AMB-IDS** controllers

Code 0-10V	Wattage	Lumens	Length (mm)
WP4A-T8-20W-010*	20W	2400lm	1200 x 28
WP4A-T8-24W-010*	24W	2880lm	1500 x 28
WP4A-T8-28W-010*	28W	3360lm	1800 x 28

\* Add Colour Temperature to Code: ○ **WW** (3000K), ○ **CW** (4200K), ○ **DL** (5000K)

### Accessories

Code	Description
AMB-PE	1m Power Extension
AMB-ME	2.8m Middle Extension
AMB-TC	"T" Connector
AMB-SK	Suspended Mounting Kit (Complete for 1 Tube)
AMB-CM	Ceiling Mounting Kit (Complete for 1 Tube)

### System Example for Poultry Controller

#### EPC-T10 Block Diagram

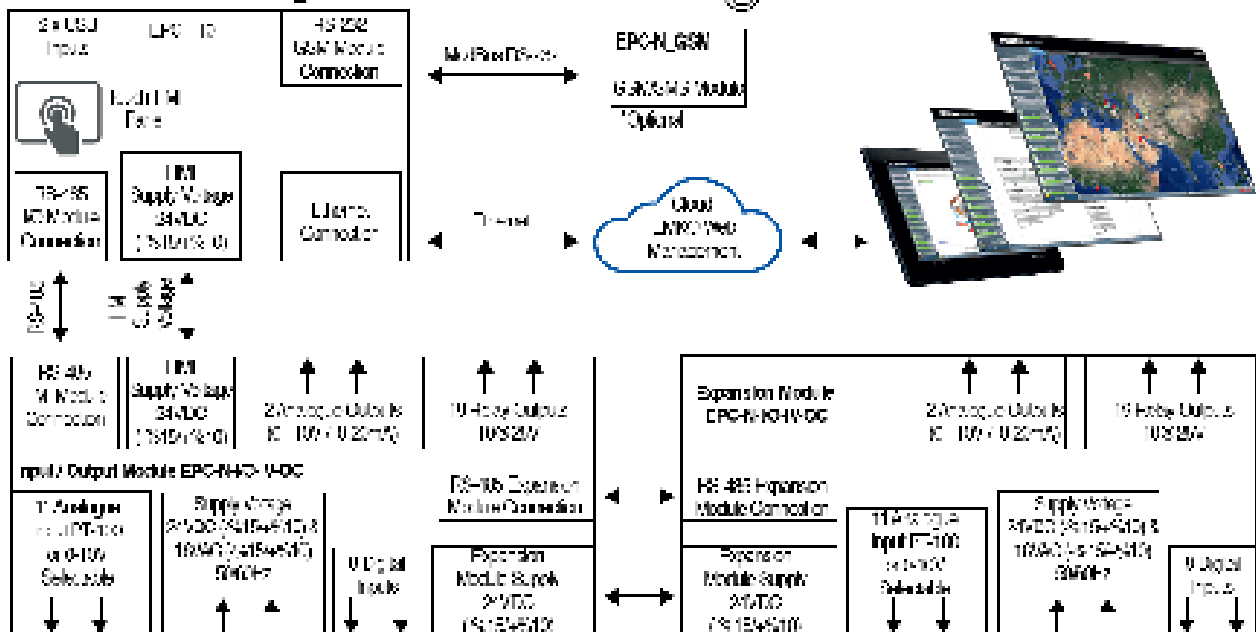

\* Max 2 Input/Output modules can be connected to EPC-T10 HMI panel

# AUTOMATION PLC RANGE

	Micro PLC	Mid Range PLC
Programming Languages: Ladder, IL & SFC. Compatible with Mitsubishi programming software		
<b>Series</b>	<b>AX1S</b>	<b>AX2N</b>
Application Notes	Compatible with Mitsubishi FX1S	Compatible with Mitsubishi FX2N
Power Specification	100-240VAC or 24VDC	100-240VAC or 24VDC
Power Consumption	21W AC, 8W DC	100W AC, 40W DC
Ext Power supply (min)	400mA @ 24VDC	460mA @ 24VDC
Program Memory	2000 steps EEPROM	8000 steps RAM
Instructions	27 x Basic, 2 x Step ladder diagram, 85 x Applied	27 x Basic, 2 x Step ladder diagram, 132 x Applied
Operating / Processing speed	Basic Instructions, 0.55-0.7µS Applied Instructions 0-0.037µs	Basic Instructions, 0.08µS, Applied Instructions 0-0.015µs
Clock	Real time Internal	Real time Internal
Counter	16 bit increment counter: 32 Points	16 digits increment counter: 200 Points
Input Specification	24VDC, 7mA / 5mA, No Voltage contact or NPN open Collector Transistor input	Same as <b>AX1S</b> - but also with AC input 100-120VAC
Output Specification	Relay: 2A@250VAC, <30VDC Transistor: 0.5A, 5VDC-30VDC	Same as <b>AX1S</b>
Aux Relay, Timer Point	512, 64	3072, 256
Communication	RS232C, RS485 x RS422, N:N Network, Parallel Link, Computer Link	RS232C, RS485 x RS422, N:N Network, Parallel Link, Computer Link, CC-Link(LT), Melsec-I/O Link

### Base Module Choices for AX1S Series

Code	Input	Output	Dimensions
<b>AX1S-14M*..**</b>	8	6	60 x 90 x 75mm
<b>AX1S-30M*..**</b>	16	14	100 x 90 x 75mm

\* Add to Code: **R** for Relay Output or **T** for Transistor Output  
\*\*Add to Code: **ESS** for AC Power source or **D** for DC power source

### Expansion Boards for AX1S Series

Can accommodate one expansion board below the face plate, inside the enclosure



Code	Description
<b>AX1S-4AX-BD</b>	4 x 24VDC Inputs
<b>AX1N-2EYT-BD2</b>	2 x Transistor outputs
<b>AX1N-2AD-BD</b>	2 x 0-10VDC 2.5mV res or 4-20mA 8µA res Inputs
<b>AX1N-1DA-BD</b>	1 x 0-10VDC 2.5mV res or 4-20mA 8µA res Output
<b>USB-SC-09-3M</b>	5M USB Programming cable for <b>AX</b> series
<b>AX1N-232-BD</b>	RS232 Half Duplex bi-directional, 15m max
<b>AX1N-422-BD</b>	RS422 to connect peripheral devices
<b>AX1N-485-BD</b>	RS485 Half Duplex, single direction, 50m max

### HMI Devices



Code	USPX-121-6	USPT-080-4	USPK-043-10
Touch panel	5 Wire resistive	4 Wire resistive	4 Wire resistive
Size (mm)	351.3x245.8	231.5x174.5	130x106
Resolution	1024x768	800x600	480x272
Working Memory	256MB	64MB	32MB
Total Mem. Capacity	1GB	8MB NOR	Flash ROM
Battery Backed Ram	1MB	128KB (1MB opt.)	128KB
Comms	RS232/485/422	RS232/485/422	RS232/485/422
CPU	800MHz	200MHz	ARM926/EJ
USB	1	1	1
Ethernet	Yes	Yes	No
Voltage	24VDC	24VDC	24VDC
IP Rating	<b>IP66</b>	<b>IP66</b>	<b>IP65</b>

### Base Module Choices for AX2N Series

Code	Input	Output	Dimensions
<b>AX2N-32M*..**</b>	16	16	150 x 90 x 87mm
<b>AX2N-64M*..**</b>	32	32	220 x 90 x 87mm
<b>AX2N-128M*..**</b>	64	64	350 x 90 x 87mm

\* Add to Code: **R** for Relay Output or **T** for Transistor Output  
\*\*Add to Code: **ESS** for AC Power source or **D** for DC power source

### Expansion Boards for AX2N Series

Code	Description
<b>AX2N-CNV-BC</b>	<b>AX2N</b> Expansion module converter cable (connect AX0N 65EC)
<b>AX2N-65EC0</b>	<b>AX2N</b> Expansion cable 0.65M
<b>AX2N-485-BD</b>	RS 485 Interface board for <b>AX2N</b>
<b>AX2N-422-BD</b>	RS 422 Interface board for <b>AX2N</b>
<b>AX2N-232-BD</b>	RS 232 Interface board for <b>AX2N</b>

### AX2N-Series I/O Extension Unit

Code	Description
<b>AX2N-8EX</b>	Ext. Unit, 8 Inputs
<b>AX2N-8ER</b>	Ext. Unit, 4 Inputs, 4 Relay Outputs
<b>AX2N-8EYR</b>	Ext. Unit, 8 Relay Outputs
<b>AX2N-8EYT</b>	Ext. Unit, 8 Transistor Outputs
<b>AX2N-16EX</b>	Ext. Unit, 16 Inputs
<b>AX2N-16ER</b>	Ext. Unit, 8 Inputs, 8 Relay Outputs
<b>AX2N-16EYR</b>	Ext. Unit, 16 Relay Outputs
<b>AX2N-16EYT</b>	Ext. Unit, 16 Transistor Outputs
<b>AX2N-32ER</b>	Ext. Unit, 16 Inputs, 16 Relay Outputs
<b>AX2N-32ET</b>	Ext. Unit, 16 Inputs, 16 Transistor Outputs
<b>AX2N-48ER</b>	Ext. Unit, 24 Inputs, 24 Relay Outputs
<b>AX2N-48ET</b>	Ext. Unit, 24 Inputs, 24 Transistor Outputs



### AX2N-Series Analogue Extension Unit

Code	Description
<b>AX2N-2AD</b>	Extension Unit, 2 x Inputs: 0-10V, 4-20mA
<b>AX2N-2DA</b>	Extension Unit, 2 x Outputs: 0-10V, 4-20mA
<b>AX2N-4AD</b>	Extension Unit, 4 x Inputs: 0-10V, 4-20mA
<b>AX2N-4DA</b>	Extension Unit, 4 x Outputs: 0-10V, 4-20mA
<b>AX2N-4AD-PT</b>	Extension Unit, 2 Temperature (PT100)
<b>AX2N-4AD-TC</b>	Extension Unit, 2 Temperature (THERMOCOUPLE)





**NEW**

# INDUSTRIAL NETWORKING PRODUCTS AND IOT DEVICE SOLUTIONS

<b>Code</b>	<b>TRM250</b>	<b>TRB140</b>	<b>RUT240</b>	<b>ELTEBOX 2409</b>
Product type	Modem	Gateway	Router	3rd party compact outdoor directional solution
Mobile	LTE (Cat-M1)/ NB-IoT/ EGPRS	4G (LTE) – Cat 4 , 3G , 2G	4G (LTE) – Cat 4 , 3G , 2G	RUT240 based.
SIM slot	Mini SIM (2FF)	1 x SIM slot (Mini SIM – 2FF), 1.8 V/3 V	1 x SIM slot (Mini SIM – 2FF), 1.8 V/3 V	1 SIM card holder
Antenna connector	1 x SMA	1 x SMA for LTE	2 x SMA for LTE, 1 x RP-SMA for WiFi antenna connectors	Two directional internal LTE antennas with increased gain
Operating voltage	5V - powered via microUSB	9 – 30 VDC, reverse polarity protection, surge protection	9 – 30 VDC, reverse polarity protection, surge protection	9 – 30 VDC, reverse polarity protection, surge protection
Operating temperature	-40°C to 75°C	-40°C to 75°C	-40°C to 75°C	-40°C to 75°C
IP rating	<b>IP30</b>	<b>IP30</b>	<b>IP30</b>	<b>IP30</b>
Dimensions	74,5 x 64,5 x 25mm	60 x 70 x 18mm	83 x 74 x 25mm	272 x 276 x 96mm
Protocols	TCP/UDP/PPP/FTP(S)/ HTTP(S)/NTP/PING/QMI/SSL	TCP, UDP, IPv4, IPv6, ICMP, NTP, DNS, HTTP, HTTPS, SSL, v3, TLS, SSH, DHCP, MQTT, WOL	TCP, UDP, IPv4, IPv6, ICMP, NTP, DNS, HTTP, HTTPS, FTP, SMTP, SSL v3, TLS, ARP, VRRP, PPP, PPPoE, UPnP, SSH, DHCP, Telnet, SMNP, MQTT, WOL	This unit amplifies the signal of the <b>RUT240</b>

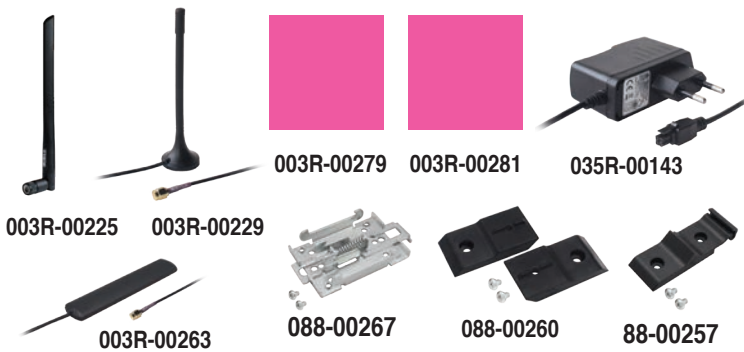

## Expansion Boards for AX2N Series

Code	Description
003R-00225	Mobile SMA antenna
003R-00279	Angled compact mobile antenna
003R-00281	Straight compact mobile antenna
003R-00229	Mobile magnetic SMA antenna
003R-00263	Mobile adhesive SMA antenna
035R-00143	EU Power Supply, 9W
088-00267	Din Rail Kit
088-00257	Compact DIN rail kit
088-00260	Surface mounting kit

# INDUSTRIAL HIGH SPEED ROUTERS

**WLINK**

- IOT Mobile Broadband Router and machine to machine (M2M) Industrial Cellular Routers.
- With Remote Management



Code	WLR100H4	WLR100LF	WLR200H4W	WLR200LFW	WLR210HD	WLR520H4D	WLR520LFD
Network type	3G	3G/4G (LTE)	3G	3G/4G (LTE)	3G	3G	3G/4G (LTE)
Wi-Fi	No	No	Yes	Yes	Yes	Yes	Yes
Supply Voltage	5-32VDC	5-32VDC	5-32VDC	5-32VDC	5-32VDC	5-36VDC	5-36VDC
SIM	Single	Single	Single	Single	Dual	Dual	Dual
Ethernet	1 x LAN	1 x LAN	2 x LAN	2 x LAN	2 x LAN	4 x LAN, 1 x WAN	4 x LAN, 1 x WAN
Digital In/Outputs	-	-	-	-	2DI, 1DO	-	-
Serial Port	1 x RS232	2 x RS232	-	-	1 x RS232	1 x RS232	1 x RS232

# GSM / TELEMETRY CONTROLLERS

A product range used for PLC-Type Telemetry applications. Allows users to be notified of remote events and enables the user to control remote equipment - all from a cell phone. No PLC required, complete standalone unit. Easy to configure and install.



### GSM Commander - Base Unit

Standard Code	GC0101-*	GC0321-*	GC0641-*	GC1281-*
3G Enabled Code	GC0101-3G-*	GC0321-3G-*	GC0641-3G-*	GC1281-3G-*
Type	Micro	LITE	STANDARD	PROFESSIONAL
Onboard Inputs	1	2	2	2
Onboard Outputs	1	2	2	2
Max. Extendable I/O	None	12/12	22/22	32/32
GPRS Functionality	Lite	Lite	Full	Full
No. of Statements	10	32	64	128
Setup Memory	2kB	2kB	4kB	8kB
Temp Probes Supported	0	2	2(10)	2(10)
Analogue Inputs	0	1	1(9)	1(9)
Battery/Power Monitors	Yes	Yes	Yes	Yes
USB Configuration	Yes	Yes	Yes	Yes
DTMF Decoder	No	No	Yes	Yes
SIM Card Slots	1	1	1	2 (Dual)
Size (mm)	126 x 72 x 26	148 x 86 x 28	148 x 86 x 28	148 x 86 x 28

**NEW**

Historian - 30 Credits/Device/Month		Editor - 100 Credits/Device/Month	
Realtime View	✓	Realtime View	✓
History View	✓	History View	✓
History Export	✓	History Export	✓
Events Realtime View**	✓	Events Realtime View**	✓
Events History View**	✓	Events History View**	✓
Events History Export**	✓	Events History Export**	✓
Remote Setups	-	Remote Setups**	✓
Remote Control Outputs	-	Remote Control Outputs**	✓

Specify if you would like to order a kit or only a base unit.  
 \* Add to code: **OEM** (base unit only) or **BOX** (kit including basic antenna, power supply, USB cable and software CD).  
 \*\* Features are Model Dependant only for **GC0641** & **GC1281**

Features:	Description:
Digital Inputs	Opto-isolated. Can accept DC signals of any type. (Dry Contacts, Open Collector (PNP/NPN), DC Voltage (10-20V)).
Digital Outputs	SPDT 8A @ 10-48VDC or 4A @ 110-400VAC
Supply Voltage	10-24VDC (12VDC) Can accommodate a 12V 1.2Ah backup battery. Code for battery <b>BATT1.2AH</b> . c/w built-in charger.
Consumption	60mA Acquiscent
DTMF Decoder	If present the unit is able to detect and respond to key presses during a voice call.
No. of Statements	A measure of the complexity that can be programmed into the unit. Each statement is in the form IF <ABC Happens> THEN <do something>. e.g. IF Input 1 goes active THEN send "Generator tripped" to 083 123 1234
Programming	Unit can be programmed using the software supplied via USB or via SMS

### Expansion Units



Code	Description
<b>GX0505</b>	5 x Input and 5 x relay Output Expansion Module Dimensions: 147 x 103 x 28mm
<b>GX1000</b>	Expansion unit with interface cable: 10 x Opto-isolated Inputs
<b>GXS081A</b>	8 x Input analogue expansion 4-20mA 10-30V (Serial Interface only for <b>GC0641</b> & <b>GC1281</b> )
<b>GXS082T</b>	8 (4 groups of 2 each) Temperature Probe Expansion (only <b>GC0641</b> & <b>GC1281</b> )



Cable Theft Prevention	
<b>CTM001</b>	Cable theft monitor for 3 phase & Single phase cable.
<b>IVS002</b>	Intelligent Vibration Sensor - Adjustable (normally closed)
<b>DCR-03</b>	DC Reflector for use with <b>CTM001</b>

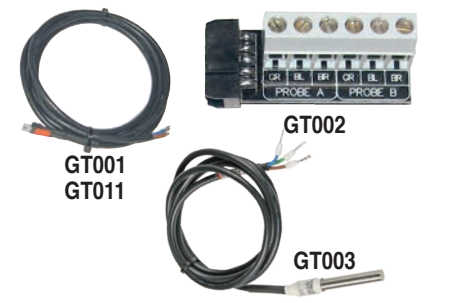

Accessories - Temperature	
<b>GT002</b>	Temperature interface to connect 2x temp. probes to units (Probes not included)
<b>GT001-1</b>	2 to 100°C Temperature Probe with 2m Cable. Type TR2 (Requires <b>GT002</b> )
<b>GT001-2</b>	2 to 100°C Temperature Probe with 4m Cable. Type TR2 (Requires <b>GT002</b> )
<b>GT011-1</b>	-15 to 35°C Temperature Probe with 2m Cable (Requires <b>GT002</b> )
<b>GT011-2</b>	-15 to 35°C Temperature Probe with 4m Cable (Requires <b>GT002</b> )
<b>GT011-3</b>	-15 to 35°C Temperature Probe with 8m Cable (Requires <b>GT002</b> )
<b>GT003A</b>	Primary Sensor for <b>GXS082T</b> -50 to 120°C 1m Cable
<b>GT003B</b>	Secondary Sensor for <b>GXS082T</b> -50 to 120°C 1m Cable



Cables	
<b>GS005</b>	5m Low Loss Extensions Lead for Antenna
<b>GS020</b>	Expansion Ribbon Cable 20cm
<b>GS030</b>	Serial (RS232) Communication Cable
<b>GS040</b>	Serial (RS232) to USB Converter / Adaptor
<b>CON-01</b>	Cable & Connector set GSM Commander



Power Supply	
<b>DRA18-12</b>	1.25A 12V Regulated DIN Mount Power Supply
<b>PSU1417</b>	1700mA 14V Metal Switching Power Supply
<b>BATT1.2AH</b>	12V 1.2AH Sealed Lead Acid Battery
<b>BP001</b>	Battery Protector – Protects batteries against under-voltage, over-current

## GSM CONTROLLER ACCESSORIES



### Antennas

<b>GA002</b>	3dBi Magnetic base Antenna with 1m Cable
<b>GA004</b>	5dBi Outdoor Antenna - Screw Mount. 3.5m Cable
<b>GA007</b>	2dBi Knobby Antenna - Screw Mount
<b>GA008</b>	12dBi Outdoor Yagi Antenna
<b>GA009</b>	5dBi Magbase Antenna with 1m cable
<b>GA012</b>	12dBi Magbase Antenna with 3m cable
<b>GA200</b>	Stealth Outdoor 2dBi Pentaband Antenna (ultra-rugged) Stealth
<b>GA210</b>	Outdoor 2dBi Pentaband Antenna with vibration sensor

## GSM / TELEMETRY KITS

The Makulu is a complete panel, ready to go. Designed with lazer-cut and electroplated brackets, it is set up with all the goodies you normally need in an installation. NO HOLES to be drilled by you! EVER!



### Standard Kits include:

- 7 inputs / 7 outputs
- Optional expansion space for 1 temperature or 1 analogue or 1 cable theft monitor expansion
- Space for 1 I/O expansion
- 7 AH Battery with protector (Solar Makulu includes 1 extra 12V 7AH Battery)
- Built in temperature module (GT002)
- **Dimensions 300x400x250mm**

### Makulu - Direct 230V Power

Code	Description
<b>RTM-M0321</b>	<b>GC0321</b> - LITE Version Ready to Mount Solution.
<b>RTM-M0641</b>	<b>GC0641</b> - STANDARD Version Ready to Mount Solution.
<b>RTM-M1281</b>	<b>GC1281</b> - PROFESSIONAL Version Ready to Mount Solution.

### Makulu - Solar Powered (Use Max 1x20 Watt Panel)

<b>SOL-M0321</b>	<b>GC0321</b> - LITE Version Solar Ready to Mount Solution.
<b>SOL-M0641</b>	<b>GC0641</b> - STANDARD Version Solar Ready to Mount Solution.
<b>SOL-M1281</b>	<b>GC1281</b> - PROFESSIONAL Version Solar Ready to Mount Solution.

### Specifications

- 6 x 8A SPDT Relay outputs (expandable up to 32\*)
- 1 x 30Amp SPDT Relay outputs
- 7 x Optically Isolated inputs (expandable up to 32\*)
- 2 x Temperature Inputs (expandable up to 10\*\*)
- 1 x Analog input (expandable to 9\*\*)
- 2 x Pulse Stretchers (on input 6 and 7)
- Dedicated Battery Charger\*\*\*
- 25W Rugged Meanwell AC-DC Switching PSU\*\*\*
- AC/DC Filter with Surge Protection\*\*\*
- External 2 dBi Knobby Antenna
- Door Switch and Temperature Expansion
- User dedicated DIN-Rail Space

**Note: Solar Panels & Regulator not included, use SLP020-12 & LS0512EU**

\*Only space for 1 x I/O expansion unit inside Makulu. Additional expansions to be located separately. Dependant on model.  
 \*\* EITHER the Analog OR the Temperature inputs can be expanded, not both at the same time.  
 \*\*\* Not included in Solar Makulu.

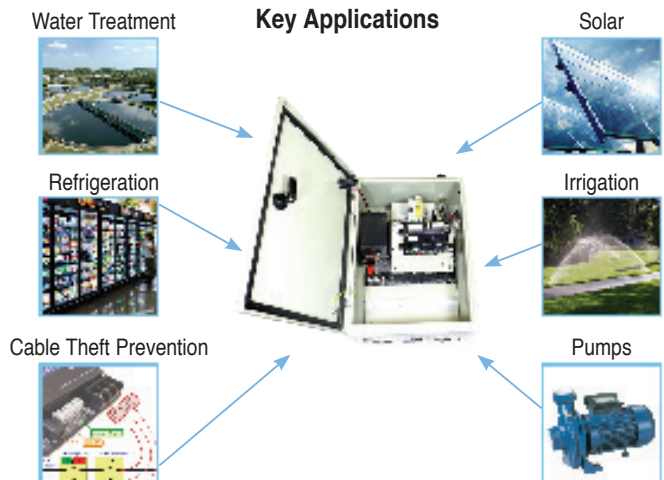

The Pico is a small, complete panel, ready to go. Designed with lazer-cut and electroplated brackets, it is set up with the goodies you need for a minimalistic installation. NO HOLES to be drilled by you! Ever!



### Standard Kits include:

- 2 inputs / 2 outputs
- 1.2AH Battery with protector (replaced with 12V 7AH Battery for Solar Makulu)
- **Dimensions 200x250x50mm**

### Pico - Direct 230V Power

Code	Description
<b>RTM-P0321</b>	<b>GC0321</b> - LITE Version Ready to Mount Solution.
<b>RTM-P0641</b>	<b>GC0641</b> - STANDARD Version Ready to Mount Solution.
<b>RTM-P1281</b>	<b>GC1281</b> - PROFESSIONAL Version Ready to Mount Solution.

### Pico - Solar Powered (Use Max 1x10 Watt Panel)

<b>SOL-P0321</b>	<b>GC0321</b> - LITE Version Solar Ready to Mount Solution.
<b>SOL-P0641</b>	<b>GC0641</b> - STANDARD Version Solar Ready to Mount Solution.
<b>SOL-P1281</b>	<b>GC1281</b> - PROFESSIONAL Version Solar Ready to Mount Solution.

### Specifications

- 2 x 8A SPDT Relay outputs (expandable up to 32\*)
- 2 x Optically Isolated inputs (expandable up to 32\*)
- 1 x Analog input (expandable to 9\*)
- 25W Rugged Meanwell AC-DC Switching PSU\*\*
- Optional Built-in 400V-220V Transformer\*\*
- External 2 dBi Knobby Antenna
- Door Switch

**Note: Solar Panels & Regulator not included, use SLP010-12 & LS0512EU**

\*No space inside the Pico for expanded I/O. Any expansion units must be located outside of the box in a separate enclosure. Dependant on model.  
 \*\* Not included in Solar Pico

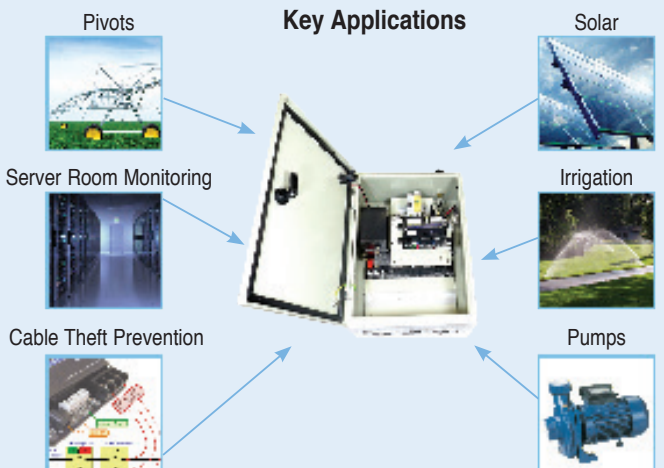



## STAINLESS STEEL FLOAT SWITCHES IP65

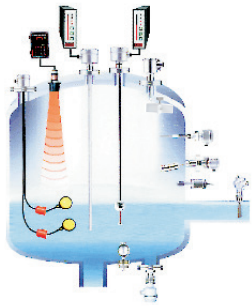

Side Mount - RF-3002D

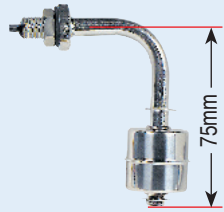

Top or bottom mount - RF-3001

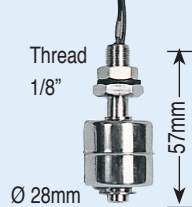

LF-10CEQ

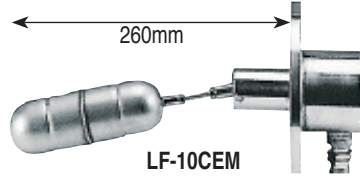

LF-10CEM & FF-70SSS

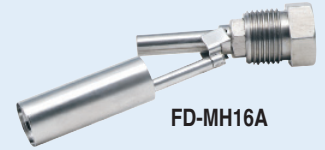

FD-MH16A

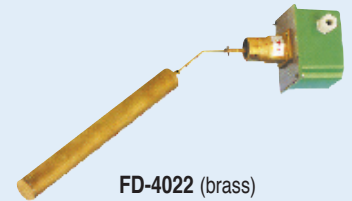

FD-4022 (brass)

Code	Top/Bottom	Side Mount	LF-10CEM	LF-10CEQ	FF-70SSS	FD-MH16A	FD-4022
	RF-3001	RF-3002D					
Mounting	1/8" PF	1/8" PF	Flange	1 1/2" PT	Explosion Proof Flange	1/2" PT Adaptor	1"
Thread Size	1/8" PF	1/8" PF					
Length of Cable	300mm			-		300mm	-
Switching Voltage Max.	240VAC/200VDC			250VAC/200VDC		250VAC	250VAC
Switching Current Max.(A)	0,5A			2A		0.5A	5A
Carry Current Max.(A)	1A			5A		1A	16A
Switch Type	Reed Switch N.O. or N.C.			Reed Switch 1C/O		Reed Switch N.O.	Micro Switch C/O.
Max. Pressure	8.5 Bar			12.8 Bar		4.2 Bar	10 Bar
Operating Temperature	-20°C to 120°C			-25 to 100°C		-10 to 120°C	-10 to 120°C
Material	304 Stainless Steel		Housing: Aluminium IP65. Wetted parts 304 S/S			304 Stainless Steel	Brass
Suitable Specific Gravity	0.75 S.G.			0.65 S.G.		0,8 S.G.	0,8 S.G.
Resistance to:	Water & Liquids			Water, Acids & Oils		Seawater, Corrosive Liq.	Non-Aggressive Liq.

## LEVEL PROBES & SENSORS

More Float Switches	Probe Assemblies	Probe Components	Conductive Probe Kits IP65																				
<p><b>RF-OV61</b> 1 x Reed</p> <p><b>RF-PV2</b> 2 x Reed</p>	<p><b>APS - 3C</b>    <b>APS - 5C</b></p>	<p><b>PS-5S</b>    <b>APS-3</b>    <b>AF-12</b></p> <p><b>PF-101</b>   <b>PF-102</b>   <b>PF-103</b>   <b>PF-104</b></p> <p><b>PF-101P</b></p>	<p><b>RHOMBERG</b> <b>RHE</b></p> <p><b>Coated</b>    <b>CP1/C</b>   <b>CP2/C</b>   <b>CP3/C</b></p> <p><b>Uncoated</b>    <b>CP1</b>    <b>CP2</b>    <b>CP3</b></p> <p>• Material: Nylon • Thread: 1.5" BSP • Max Temp: 70°C</p> <p><b>Accessories</b></p> <p><b>Code</b>    <b>Description</b></p> <p><b>CP1/CX</b>    1-Way Head only <b>CP2/CX</b>    2-Way Head only <b>CP3/CX</b>    3-Way Head only <b>DD2</b>        2-Way Probe Spacer <b>DD3</b>        3-Way Probe Spacer <b>EP1/C</b>      Spare 1m s/s Rod coated <b>EP1/U</b>      Spare uncoated s/s Rod 1m <b>EP1/EXT</b>   M4 Connecting Nut Brass</p> <p>Coating of the rods improves resistance, prevents switching caused by frothing or condensation.</p>																				
<p><b>RF-OV61</b>    <b>RF-PV2</b></p> <ul style="list-style-type: none"> <li>• Thread Size: 1/8" PF</li> <li>• Output Reed Switch @ 1A 250VAC</li> <li>• Switching 1xReed Switch N.O.</li> <li>• Switching 2xReed Switches Top N.O., Bot. N.C.</li> <li>• Max Pressure: 4kg/cm<sup>2</sup></li> <li>• Material: Polypropylene (PP)</li> <li>• Specific Gravity: 0.7 S.G.</li> <li>• -20 to 80°C</li> </ul>	<p><b>APS-3C 3-way</b>   <b>APS-5C 5-way</b></p> <ul style="list-style-type: none"> <li>• 3 or 5-way holder</li> <li>• Steel locking ring</li> <li>• 3 or 5 x 1m 204 S/S probes</li> <li>• Suitable for use with all liquid level relays e.g. <b>TE101 – APS-3C, DLR – APS-5C</b></li> <li>• Max temperature: 100°C</li> <li>• Cut Probes to suit application</li> </ul>	<table border="1"> <thead> <tr> <th>Code</th> <th>Description</th> </tr> </thead> <tbody> <tr> <td><b>APS-3</b></td> <td>3 Probe holder only (6 mm thread)</td> </tr> <tr> <td><b>PS-5S</b></td> <td>5 Probe holder only</td> </tr> <tr> <td><b>AF-12</b></td> <td>Steel locking ring for holders - 115mmØ</td> </tr> <tr> <td><b>PF-101</b></td> <td>3 Probe Spacers (porcelain)</td> </tr> <tr> <td><b>PF-101P</b></td> <td>3 Probe Spacers (plastic)</td> </tr> <tr> <td><b>PF-105</b></td> <td>5 Probe Spacers (porcelain)</td> </tr> <tr> <td><b>PF-102</b></td> <td>Connecting nut (304 stainless steel)</td> </tr> <tr> <td><b>PF-104</b></td> <td>Tank probe</td> </tr> <tr> <td><b>PF-103</b></td> <td>1m 304 stainless steel rod 6mmØ</td> </tr> </tbody> </table>	Code	Description	<b>APS-3</b>	3 Probe holder only (6 mm thread)	<b>PS-5S</b>	5 Probe holder only	<b>AF-12</b>	Steel locking ring for holders - 115mmØ	<b>PF-101</b>	3 Probe Spacers (porcelain)	<b>PF-101P</b>	3 Probe Spacers (plastic)	<b>PF-105</b>	5 Probe Spacers (porcelain)	<b>PF-102</b>	Connecting nut (304 stainless steel)	<b>PF-104</b>	Tank probe	<b>PF-103</b>	1m 304 stainless steel rod 6mmØ	<p><b>DD3</b>    <b>EP1/C</b></p>
Code	Description																						
<b>APS-3</b>	3 Probe holder only (6 mm thread)																						
<b>PS-5S</b>	5 Probe holder only																						
<b>AF-12</b>	Steel locking ring for holders - 115mmØ																						
<b>PF-101</b>	3 Probe Spacers (porcelain)																						
<b>PF-101P</b>	3 Probe Spacers (plastic)																						
<b>PF-105</b>	5 Probe Spacers (porcelain)																						
<b>PF-102</b>	Connecting nut (304 stainless steel)																						
<b>PF-104</b>	Tank probe																						
<b>PF-103</b>	1m 304 stainless steel rod 6mmØ																						

# PROBE & ROTARY LEVEL SWITCHES

## Optical Level Sensor IP68

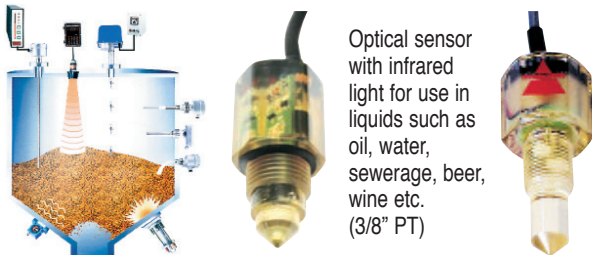

Optical sensor with infrared light for use in liquids such as oil, water, sewerage, beer, wine etc. (3/8" PT)

Code	SD10G-ARN1 (NPN NO) SD10G-ARP1 (PNP NO)	VP02-230TB Un-modulated	VR1A 8mm Sensing	VR1B 15mm Sensing
Length of cable	2 meters		5 meters (PVC)	
Switching Voltage	10-28VDC (NPN, N.O.)	230VAC (N.O.)	20-30VDC (1kΩ)	
Operating Temperature	-20°C to 80°C		0°C to 70°C	
Material	Polysulphone		Polyester	
Switching Current Max (A)	DC: 100mA	AC: 100mA	10A @ 250VAC	
Max ambient light	5000 lux	100 lux	For use with amplifier Relay Type CLR2 pg 9	

DC Units for use with Relay Type CLR1 pg 9

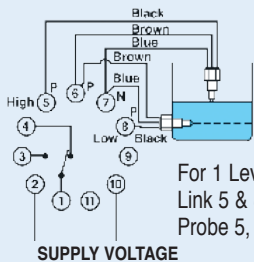

For 1 Level Control only  
Link 5 & 8  
Probe 5, 6, 7

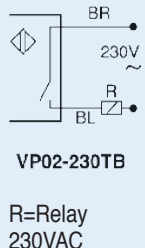

VP02-230TB  
R=Relay  
230VAC

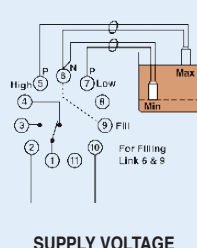

SUPPLY VOLTAGE

## Capacitive Level Sensors for Solids



Capacitive level sensor for solid, fluid or granulated substances.  
32mm Ø

## Vibration Probe Switch



- Mounting Thread 1"
- Probe Material S/S 304
- Housing Alu. IP65
- Output: 5A @ 250V 1C/O
- Supply: 0-110-230VAC
- Vibrating Frequency: 360-370Hz
- Operating Temp.: -10 to 80°C
- Material Density: 0.32g/cm<sup>2</sup>

## Rotary Paddle Switch

For use in: Milk Powder, Cement, Fertilizer, Granulated products, etc.



RP10C

RP80C

Code	RP10C	RP80C	
Mounting Thread Size	1"PF	¾"PF	
Torque	0.5 -1kg	Adjustable	
Gravity	>0.50 S.G	<0.3 S.G	
Contact Type	Micro Switch 1C/O		
Contact Rating	5A	5A	
Operating Temp	-10 - 60°C	-40 - 85°C	
Housing Material	Aluminium IP65		
Spare Paddle	Code	RP10-PADDLE	RP80-PADDLE

## TUNING FORK LEVEL SWITCH IP65

### Vibration Fork Level Switch



Code	SC1420-R	SC1400-R	SC2406-D
• Mounting Thread 1" PT			
• Probe Material 316			
• Housing Alu. IP65			
• Output: SPDT 5A 250VAC/28VDC		• Output: 2Wire 3mA	
• Supply Voltage: 20-250VAC, 50/60Hz VAC/DC		• Supply Voltage: 20-250VAC, 50Hz	
• Vibrating Frequency 350~370Hz		• 2 Wire electronic switch	
• Operating Temp in Bin: -40~130C		• Fork Length: 100m	
• Material Density: >0.07 g/cm <sup>3</sup>		• Operating Temperature: -40~60°C	
• Fail Safe Protection			

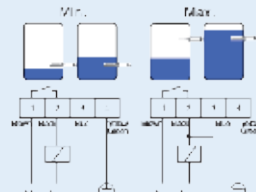

## CAPACITIVE LEVEL SWITCH IP65

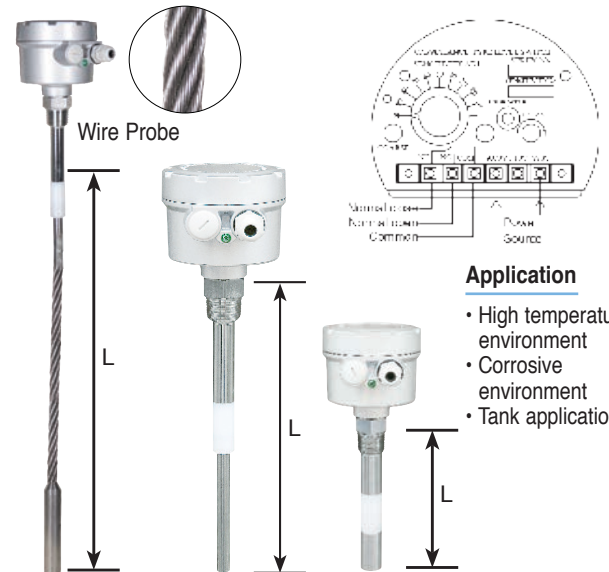







### Application

- High temperature environment
- Corrosive environment
- Tank application

Code	SA150A L = 1m	SA111A-DQ-250 L = 250mm	SA110A-DQ-150 L = 150mm
------	------------------	----------------------------	----------------------------

- Mounting Thread 1"PT
- Probe Material Stainless Steel 304
- Housing Alu. IP65
- Output: 5A @ 250V, Relay
- Supply Voltage 110/230VAC 50/60Hz
- Sensitivity Range 10pf, STD
- Operating Temp in Bin: -20°C - 60°C
- Operating Pressure: 20kg/cm<sup>3</sup>

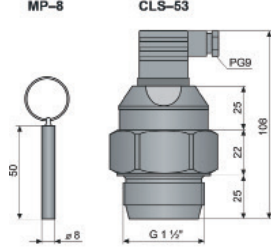
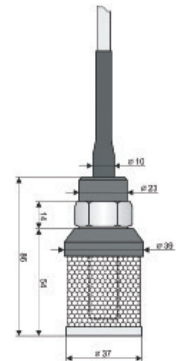
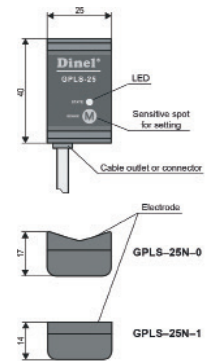
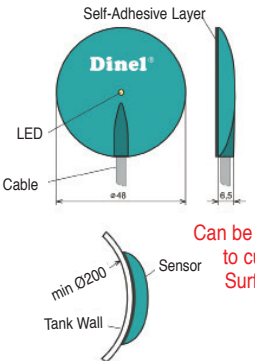
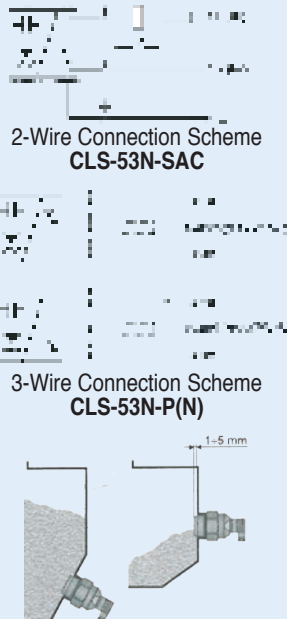
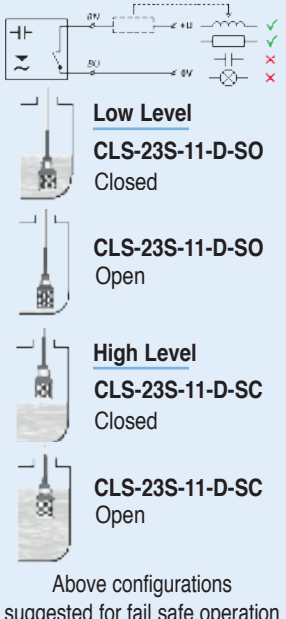
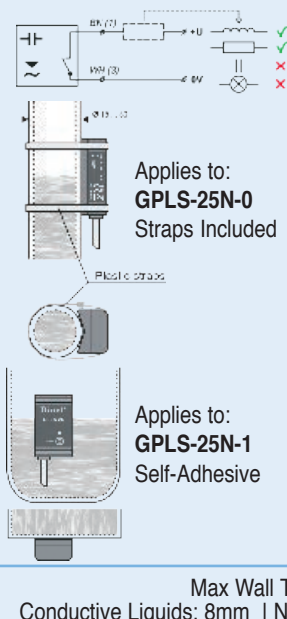
## LIMIT LEVEL SENSORS

	Capacitive Level Switch	Submersible Level Switch	Thru Wall Level Switch	Flexible Level Switch
	<p>For detection of bulk solid, fragmental and extruded materials</p> 	<p>For level detection of water in wells, boreholes, reservoirs and tanks</p> 	<p>For liquids limit level sensing on non-conductive (glass or plastic) gauge pipes, tubes and tank walls</p> 	<p>For limit level sensing of liquids in non-conductive plastic and glass vessels</p> 
<b>Code</b>	<b>CLS-53N-*</b>	<b>CLS-23S-11-D-S*</b>	<b>GPLS-25N-*-A-S</b>	<b>FLD-48N</b>
Mounting	G1½" Threaded	Suspended by Cable	*0 - Tube Mounting Ø15-50mm *1 - Flat Surface	Surface-Self Adhesive
Supply Voltage	20-230VAC/DC (SAC Version) 7-36VDC (P/N Version)	6-30VDC	6-30VDC	6-30VDC
Output Type	* Add Output Type to code: <b>SAC:</b> NO (2-Wire); <b>P:</b> PNP; <b>N:</b> NPN	* Add Output Type to code: <b>O:</b> NO (Low Level) <b>C:</b> NC (High Level)	NO or NC Programmable	NO or NC Programmable
Switching Current	0.3A (SAC) 0.2A (P/N)	40mA Max (To switch miniature relay only)	40mA Max (To switch miniature relay only)	40mA Max (To switch miniature relay only)
Settings	Simple sensitivity setting by means of magnetic pen (incl)	-	Simple sensitivity setting by means of magnetic pen (incl)	Configuration and adjustment by third programming wire (incl)
Ambient Temperature	-20° to 60°C	-20° to 70°C	-20° to 80°C	-10° to 60°C
Protection	<b>IP65</b>	<b>IP68</b>	<b>IP67</b>	<b>IP67</b>
Housing Material	Polypropylene	Plastic Polypropylene	Plastic Polypropylene	Polyurethane
Cable	Un-wired connector socket	PVC 2 x 0.75mm x 10m	PVC 2 x 0.34mm x 3m	PUR 3 x 0.14mm x 3m
<b>Dimensions</b>				 <p style="color: red; font-size: small;">Can be attached to curved surfaces</p>
<b>Wiring Diagrams &amp; Application</b>	 <p style="text-align: center;">2-Wire Connection Scheme <b>CLS-53N-SAC</b></p> <p style="text-align: center;">3-Wire Connection Scheme <b>CLS-53N-P(N)</b></p>	 <p style="text-align: center;"><b>Low Level</b> <b>CLS-23S-11-D-SO</b> Closed</p> <p style="text-align: center;"><b>CLS-23S-11-D-SO</b> Open</p> <p style="text-align: center;"><b>High Level</b> <b>CLS-23S-11-D-SC</b> Closed</p> <p style="text-align: center;"><b>CLS-23S-11-D-SC</b> Open</p> <p style="text-align: center; font-size: small;">Above configurations suggested for fail safe operation</p>	 <p style="text-align: center;">Applies to: <b>GPLS-25N-0</b> Straps Included</p> <p style="text-align: center;">Applies to: <b>GPLS-25N-1</b> Self-Adhesive</p>	
			Max Wall Thickness: Conductive Liquids: 8mm   Non-Conductive Liquids: 3mm	



## ANALOGUE ULTRASONIC LEVEL DETECTION

*For continuous no-contact level measurement of various liquid and bulk solid materials in closed or open vessels, sumps, reservoirs etc.*

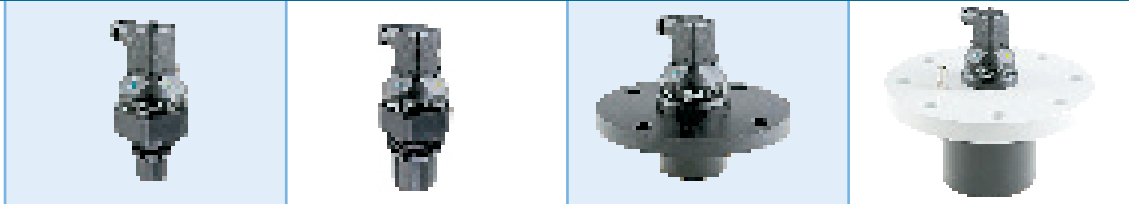

Output Type	Sensing Distance			
	0,2 - 2m	0,25 - 6m	0,4 - 10m	0,5 - 20m

**Factory Set Non-Adjustable Output Type IP68 c/w 5m Cable**

4 - 20mA (2-Wire)	ULM-53L-02-I	ULM-53L-06-I	ULM-53L-10-I	ULM-53L-20-I
0 - 10V (3-Wire)	ULM-53L-02-U	ULM-53L-06-U	ULM-53L-10-U	ULM-53L-20-U
Modbus RS-485 Output	ULM-53L-02-M	ULM-53L-06-M	ULM-53L-10-M	ULM-53L-20-M

**Field Adjustable Output Type IP67 c/w Connector Socket**

4 - 20mA (2-Wire)	ULM-53N-02-I	ULM-53N-06-I	ULM-53N-10-I	ULM-53N-20-I
0 - 10V (3-Wire)	ULM-53N-02-U	ULM-53N-06-U	ULM-53N-10-U	ULM-53N-20-U

**Explosionproof Field Adjustable Type - Must be used with IRU-420 (Below) c/w Connector Socket**

4 - 20mA (2-Wire) EX Rating 	ULM-53XI-02-I  Suitable for explosive areas (combustible gases or vapours) ⚠ II 1/2G Ex ia IIB T5 Ga/Gb with isolating repeater (IRU-420) the whole level meter – zone 1, front head part – zone 0	ULM-53XI-06-I  Suitable for explosive areas (combustible gases or vapours) ⚠ II 1/2G Ex ia IIB T5 Ga/Gb with isolating repeater (IRU-420) the whole level meter – zone 1, front head part – zone 0	ULM-53XI-10-I  Suitable for explosive areas (combustible gases or vapours) ⚠ II 1/2G Ex ia IIA T5 Ga/Gb with isolating repeater (IRU-420) the whole level meter – zone 1, front head part – zone 0	ULM-53XI-20-I  Suitable for explosive areas (combustible gases or vapours) ⚠ II 2G Ex ia IIA T5 Gb with isolating repeater (IRU-420) the whole level meter – zone 1
------------------------------------	---	---	---	--

Mounting Type	G1"	G1½"	Polypropylene	Aluminium Alloy Flange
Supply Voltage	18 - 36VDC (18 - 30VDC For XI Versions)			
Accuracy	0.20%			
Ambient Temperature	-30° to 70°C		-30° to 60°C	

**Dimensions**

ULM-53N-02	ULM-53L-02	ULM-53N-06	ULM-53L-06
ULM-53N-10	ULM-53L-10	ULM-53N-20	ULM-53L-20

**Isolating Repeater - for use with ULM-53XDI**



Code	IRU-420-I*	IRU-420-H*	IRU-420-U*
Input Signal	0/4 - 20mA	4 - 20mA	4 - 20mA
Output Signal	0/4 - 20mA	4 - 20mA	0 - 10V
Bi-directional Trans			
Communication signal	NO	YES	NO
HART™			

\*Add Voltage to Code: **24V** (18-30VAC/18-40VDC) **230V** (60-230VAC/85-230VDC)

II(1)G[EE ia] IIB /IIC

I(M1)G[EE ia] I

**Wiring Diagrams**

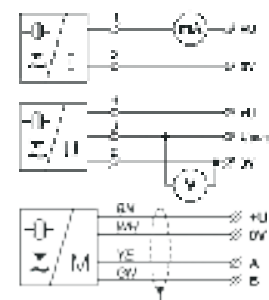

(versions with RS-485 Output)

## THERMAL DISPERSION FLOW SWITCHES

Type	Compact Model	High Temp Model	Economy Model
<ul style="list-style-type: none"> <li>Measures the velocity of liquid inside a pipe or channel</li> <li>High sensitivity and accuracy</li> <li>Can be calibrated for liquids with different density and purity</li> <li>Pmax: 100 Bar</li> </ul>	 40.5mm  31mm	 72.5mm  31mm	 69mm  31mm
Code	SP200-0-BU-* <sup>-</sup> 2	SP202-L-BU-* <sup>-</sup> 2	SP220-0-BU-* <sup>-</sup> 2
Output Type: *Add to Code:	<b>N:</b> NPN Open Collector (400mA Max) <b>P:</b> PNP Open Collector (400mA Max) <b>A:</b> NO (1A@30VDC) <b>B:</b> NC (1A@30VDC)	<b>N:</b> NPN Open Collector (400mA Max) <b>P:</b> PNP Open Collector (400mA Max) <b>A:</b> NO (1A@30VDC) <b>B:</b> NC (1A@30VDC)	<b>N:</b> NPN Open Collector (400mA Max) <b>P:</b> PNP Open Collector (400mA Max) <b>A:</b> NO (1A@30VDC) <b>B:</b> NC (1A@30VDC)
Connection Thread	½" NPT	½" NPT	½" NPT
Measuring Range	Water: 1 - 150 cm/s / Oil: 3-300 cm/s	Water: 1 - 150 cm/s / Oil: 3-300 cm/s	Water: 1 - 150 cm/s / Oil: 3-300 cm/s
Operating Voltage	19-30VDC	19-30VDC	19-30VDC
Operating Temperature	-20° to 80°C	-20° to 120°C	-20° to 80°C
Protection Degree	<b>IP67</b>	<b>IP67</b>	<b>IP65</b>
Housing Material	SUS304	SUS316L	SUS304/Plastic
Connection Type	4-Pole M12 Connector (c/w 2m Cable)	4-Pole M12 Connector (c/w 2m Cable)	4-Pole M12 Connector (c/w 2m Cable)
LED Indication	<div style="display: flex; justify-content: space-between;"> <div style="width: 20%;"> </div> <div style="width: 60%;"> <p><b>Wiring Diagrams</b></p> <div style="display: flex; justify-content: space-around;"> <div style="text-align: center;">             NPN output type wiring  <b>3 Wire</b> </div> <div style="text-align: center;">             PNP output type wiring  <b>3 Wire</b> </div> <div style="text-align: center;">             Relay output type wiring (NC)  <b>4 Wire</b> </div> <div style="text-align: center;">             Relay output type wiring (NO)  <b>4 Wire</b> </div> </div> </div> </div>		

## FLOW SWITCHES FOR WATER & AIR

Flow Switches for Water	Flow Switch for Air	Bargraph Panel Meter			
Paddle: 140 x 25mm  	Paddle: 175 x 80mm  	48 x 144 Bezel  	  		
FS-80	FS-2533	AS-2614	PM5022R3   PB-1471   1B94M-B		
<ul style="list-style-type: none"> <li>Housing Material: Aluminium (<b>IP65</b>)</li> <li>Paddle Material: 304 S/S</li> <li>Switch: SPDT, 60W @ 230VAC</li> <li>Operating temperature: -30 to 150 °C</li> <li>Operating Max Pressure: 355 PSI</li> <li>Pressure drop allowance: 3 PSI</li> <li>Set point tolerance: ±25%</li> <li>Repeatability difference: ±5%</li> <li>Connecting: 1" PT screw</li> <li>Weight: 850g</li> <li>Spare Paddle: <b>FS-80 PADDLE</b></li> </ul>	<ul style="list-style-type: none"> <li>3 Different Paddle lengths, 57, 88 &amp; 167mm</li> <li>Housing material: ABS (<b>IP64</b>)</li> <li>Paddle material: 304 S/S</li> <li>Switch: SPDT, 16A@230VAC</li> <li>Connecting: 1" PT screw Brass</li> <li>Operating temperature: -20 to 120 °C</li> <li>Operating pressure Max: 10kg/cm<sup>2</sup></li> <li>Set point tolerance: ±25%</li> <li>Repeatability difference: ±5%</li> <li>For piping 1" to 8"</li> <li>Adjustable setting</li> <li>Weight: 660g</li> <li>Spare Paddle: <b>FS-2533 PADDLE</b></li> </ul>	<ul style="list-style-type: none"> <li>Housing material: ABS (<b>IP64</b>) with steelbase</li> <li>Paddle material: Tinned S/S</li> <li>Brass Lever</li> <li>Switch: SPDT, 16A@230VAC</li> <li>Operating Temperature: -20 to 80 °C</li> <li>Min cut-in value 2m/sec</li> <li>Min cut-out value 1m/sec</li> <li>Weight: 400g</li> <li>Spare Paddle: <b>AS-PADDLE</b></li> </ul>	<table border="0" style="width: 100%;"> <tr> <td style="width: 50%;"> <b>PM5022R3</b>            Input: 4 - 20mA            Output: 4 - 20mA            • 4 point alarm (HH, H, L, LL) relay outputs (5A/250VAC)            • Scaling function: (0 - 1099)            • Alarm Delay: On/Off 0 - 3sec adjustment            • Under/over range indication            • Accuracy 0.1%            • Built in 24VDC/50mA sensor supply            • See page 55 &amp; 394 for Level Sensors         </td> <td style="width: 50%;"> <b>PB-1471</b>            Input: 0 - 10V            • Input: 4 - 20mA            • Display: 0 - 100%            • Accuracy: 1%            • Response Time: &lt;500mS            • Size: 96 x 24mm            • Cutout: 92 x 23mm            • Complete with 230/24VDC power supply            • See page 55 &amp; 394 for Level Sensors         </td> </tr> </table>	<b>PM5022R3</b> Input: 4 - 20mA Output: 4 - 20mA • 4 point alarm (HH, H, L, LL) relay outputs (5A/250VAC) • Scaling function: (0 - 1099) • Alarm Delay: On/Off 0 - 3sec adjustment • Under/over range indication • Accuracy 0.1% • Built in 24VDC/50mA sensor supply • See page 55 & 394 for Level Sensors	<b>PB-1471</b> Input: 0 - 10V • Input: 4 - 20mA • Display: 0 - 100% • Accuracy: 1% • Response Time: <500mS • Size: 96 x 24mm • Cutout: 92 x 23mm • Complete with 230/24VDC power supply • See page 55 & 394 for Level Sensors
<b>PM5022R3</b> Input: 4 - 20mA Output: 4 - 20mA • 4 point alarm (HH, H, L, LL) relay outputs (5A/250VAC) • Scaling function: (0 - 1099) • Alarm Delay: On/Off 0 - 3sec adjustment • Under/over range indication • Accuracy 0.1% • Built in 24VDC/50mA sensor supply • See page 55 & 394 for Level Sensors	<b>PB-1471</b> Input: 0 - 10V • Input: 4 - 20mA • Display: 0 - 100% • Accuracy: 1% • Response Time: <500mS • Size: 96 x 24mm • Cutout: 92 x 23mm • Complete with 230/24VDC power supply • See page 55 & 394 for Level Sensors				

## MICRO PHOTO SENSORS IP50

Type DC <b>BTS Series</b> <ul style="list-style-type: none"> <li>Nominal Voltage: 5-24VDC</li> <li>Output: NPN or PNP</li> <li>Load current: 100mA Max</li> <li>Housing material: PBT</li> </ul>					
Sensing Distance	5mm	5mm	5mm	5mm	5mm
Supply Voltage	5-24VDC	5-24VDC	5-24VDC	5-24VDC	5-24VDC
Emission	Infrared LED 950nm	Infrared LED 950nm	Infrared LED 950nm	Infrared LED 950nm	Infrared LED 950nm
Operation Mode	Light On / Dark On	Light on / Dark On	Light On / Dark On	Light On / Dark On	Light On / Dark On
Output LED	Red LED	Red LED	Red LED	Red LED	Red LED
Switching Frequency	2kHz	2kHz	2kHz	2kHz	2kHz

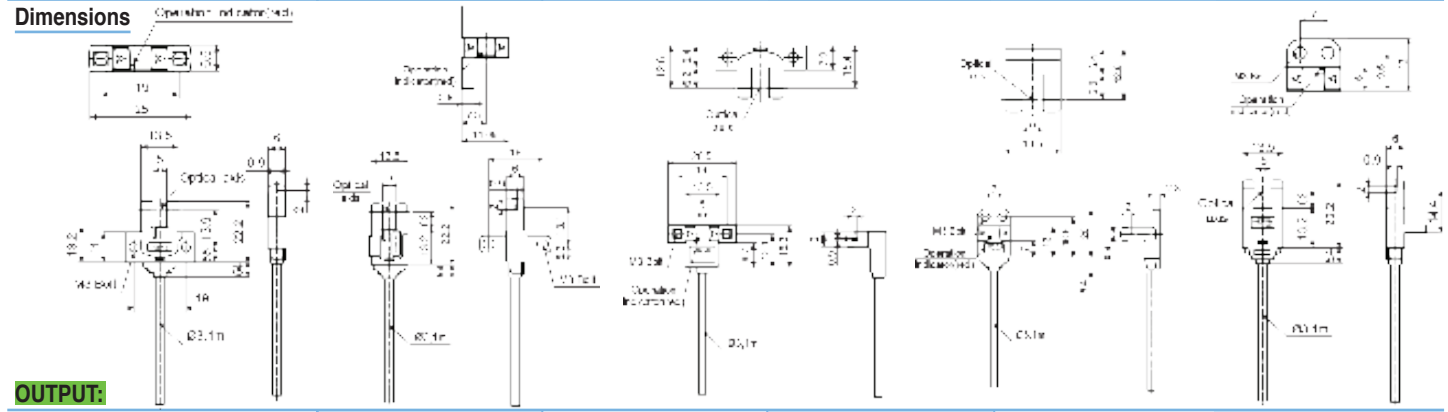

PNP Cable	<b>BS5-K1*M-P</b>	<b>BS5-T1*M-P</b>	<b>BS5-L1*M-P</b>	<b>BS5-Y1*M-P</b>	<b>BS5-V1*M-P</b>
NPN Cable	<b>BS5-K1*M</b>	<b>BS5-T1*M</b>	<b>BS5-L1*M</b>	<b>BS5-Y1*M</b>	<b>BS5-V1*M</b>

Socket : **CT-01** or **CT-02**  
 Connect the unit using socket. If it is soldered on terminal pin directly without socket, it may cause product damage.

**Wiring Diagrams**

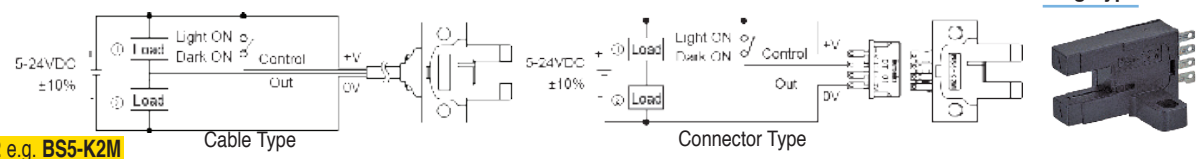

\*For plug type replace 1 with 2 e.g. **BS5-K2M**

## ULTRA SLIM PHOTOELECTRIC SENSORS IP67

Type DC <b>BTF Series</b> <ul style="list-style-type: none"> <li>Nominal Voltage: 12-24VDC</li> <li>Output: NPN or PNP</li> <li>Load current: 50mA Max</li> <li>Housing material: PBT&amp;PMA</li> <li>Cable length: 2m</li> </ul>	<b>Diffuse</b>	<b>BGS Reflective</b>	<b>Through Beam</b>
Sensing Distance	30mm	15mm	1m
DC Supply Voltage	12-24VDC	12-24VDC	12-24VDC
Emission	Red LED 650nm	Red LED 650nm	Red LED 650nm
Output LED	Red/Green	Red/Green	Red/Green
Operation Mode	Light On / Dark On	Light on / Dark On	Light On / Dark On
Dimensions (mm)	W13 x H24 x L4.6	W13 x H24 x L4.6	W13 x H19 x L4.6

**Wiring Diagrams**



<b>OUTPUT:</b>			
PNP Light	<b>BTF30-DDTL-P</b>	<b>BTF15-BDTL-P</b>	<b>BTF1M-TDTL-P</b>
PNP Dark	<b>BTF30-DDTD-P</b>	<b>BTF15-BDTD-P</b>	<b>BTF1M-TDTD-P</b>
NPN Light	<b>BTF30-DDTL</b>	<b>BTF15-BDTL</b>	<b>BTF1M-TDTL</b>
NPN Dark	<b>BTF30-DDTD</b>	<b>BTF15-BDTD</b>	<b>BTF1M-TDTD</b>
Bracket	<b>SUS304</b>	-	-
Bolt	<b>SWCH10A</b>	-	-



## ULTRA COMPACT BUILT IN AMPLIFIER PHOTOELECTRIC SENSOR IP67

Type DC BT Series	Convergent Reflective Type		Retroreflective	Through Beam
<ul style="list-style-type: none"> <li>- Nominal Voltage 12-24VDC</li> <li>- Output NPN or PNP</li> <li>- Cable Length 2m</li> </ul>				
	Sensing Distance	15mm      30mm	200mm (MS-6)	1m
DC Supply Voltage	12-24 VDC		12-24 VDC	12-24 VDC
Emission	Red LED 650nm		Red LED 650nm	Red LED 650nm
Output LED	Red - Operational / Green - Stability		Red - Operational / Green - Stability	Red - Operational / Green - Stability
Operation Mode	Light On / Dark On		Light On / Dark On	Light On / Dark On
Dimensions (mm)	W7.2 x H24.6 x L10.8		W7.2 x H24.6 x L10.8	W7.2 x H18.6 x L9.5

**Wiring Diagram**

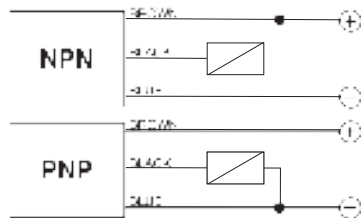

Convergent Reflective Type

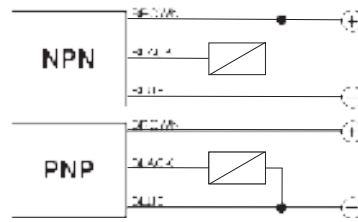

Retroreflective

**OUTPUT:**

PNP Light On	BTS15-LDTL-P	BTS30-LDTL-P	BTS200-MDTL-P	BTS1M-TDTL-P
PNP Dark On	BTS15-LDTD-P	BTS30-LDTD-P	BTS200-MDTD-P	BTS1M-TDTD-P
NPN Light On	BTS15-LDTL	BTS30-LDTL	BTS200-MDTL	BTS1M-TDTL
NPN Dark On	BTS15-LDTD	BTS30-LDTD	BTS200-MDTD	BTS1M-TDTD

## M18 FRONT / M3 SIDE MOUNT PHOTOELECTRIC SENSORS IP67

Ultimate Installation Flexibility

Type DC BH Series	Diffuse Reflective Type		Polarized Retroreflective	Through Beam
<ul style="list-style-type: none"> <li>- Nominal Voltage 12-24VDC</li> <li>- Output NPN &amp; PNP</li> <li>- Load Current 100mA</li> <li>- Housing Matreial Polycarbonate</li> <li>- Cable Length 2m</li> </ul>				
	Sensing Distance	300mm      1m	4m (MS-2A reflector)	20m
DC Supply Voltage	12-24 VDC		12-24 VDC	12-24 VDC
Current Consumption. Max	30mA      35mA	30mA	20mA	
Emission	Red LED 660nm	Infrared LED 850nm	Red LED 660nm	Red LED 660nm
Setting	Sensitivity trimmer		Sensitivity trimmer	Sensitivity trimmer
Output LED	Red - Operation/Green - Stability			
Operation Mode	Light ON / Dark ON selectable via switch			
Dimensions (mm)	W14 x H34.5 x L28	W14 x H34.5 x L28	W14 x H34.5 x L28	W14 x H34.5 x L28

**Wiring Diagram**

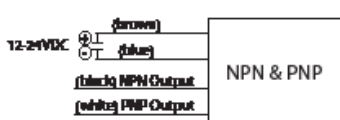

Diffuse Reflective Type



Polarized Retroreflective



Through Beam

**OUTPUT:**

NPN & PNP	BH300-DDT	BH1M-DDT	BH4M-PDT	BH20M-TDT
-----------	-----------	----------	----------	-----------

## COMPACT RECTANGULAR/SQUARE INDUCTIVE SENSORS IP67

### 3 Wire DC Inductive Sensors



	PS17-5DN	PS17-8DN	PFI25-8DN	PSN25-5DN	PSN30-10DN	PSN30-15DN	PSN40-20DN	PS50-30DN	2 Wire DC Inductive
NPN NO	PS17-5DN	PS17-8DN	PFI25-8DN	PSN25-5DN	PSN30-10DN	PSN30-15DN	PSN40-20DN	PS50-30DN	NO Output
PNP NO	PS17-5DP	PS17-8DP	PFI25-8DP	PSN25-5DP	PSN30-10DP	PSN30-15DP	PSN40-20DP	PS50-30DP	PST17-5DO
NPN NC	PS17-5DN2	PS17-8DN2	PFI25-8DN2	PSN25-5DN2	PSN30-10DN2	PSN30-15DN2	PSN40-20DN2	PS50-30DN2	NC Output
PNP NC	-	-	PFI25-8DP2	PSN25-5DP2	PSN30-10DP2	PSN30-15DP2	PSN40-20DP2	PS50-30DP2	PST17-5DC
Switching distance	5mm ±10%	8mm ±10%		5mm ±10%	10mm ±10%	15mm ±10%	20mm ±10%	30mm ±10%	5mm ±10%
Hysteresis	Max. 10% of switching distance								
Standard detecting target	18 x 18 x 1mm (Iron)	25 x 25 x 1mm (Iron)			30 x 30 x 1mm (Iron)	45 x 45 x 1mm (Iron)	60 x 60 x 1mm (Iron)	90 x 90 x 1mm (Iron)	18 x 18 x 1mm (Iron)
Response frequency	700Hz	200Hz		300Hz	250Hz	200Hz	100Hz	50Hz	
Dimensions	17 x 17 x 31	26 x 10 x 49	25 x 25 x 39	30 x 30 x 53		40 x 40 x 53	53 x 53 x 35	17 x 17 x 31	
Protection circuit	Surge protection circuit. Reverse polarity protection			Surge protection circuit. Reverse polarity protection. Overload & short-circuit protection					Surge Protection Circuit
Power supply (Operation voltage)	12-24VDC (10-30VDC)								
Leakage current	Max. 10mA								
Residual voltage	Max. 1.5V								
Affection by Temp.	-25 to +70°C								
Control output	200mA								
Insulation resistance	Min. 50MΩ (at 500VDC)								
Indicator	Operation indicator (Red LED)								
Ambient temperature	-25 – +70°C (at non-freezing status)								

### 2 Wire AC Inductive Sensors



	PSN25-5AO	PSN30-10AO	PSN30-15AO	PSN40-20AO
NO Output	PSN25-5AO	PSN30-10AO	PSN30-15AO	PSN40-20AO
NC Output	PSN25-5AC	PSN30-10AC	PSN30-15AC	PSN40-20AC
Switching distance	5mm ±10%	10mm ±10%	15mm ±10%	20mm ±10%
Hysteresis	Max. 10% of switching distance			
Standard detecting target	25 x 25 x 1mm (Iron)	30 x 30 x 1mm (Iron)	45 x 45 x 1mm (Iron)	60 x 60 x 1mm (Iron)
Dimensions	25 x 25 x 39	30 x 30 x 53	30 x 30 x 53	40 x 40 x 53
Power supply (Operation voltage)	100-240VAC (85-264VAC)			
Leakage current	Max. 2.5mA			
Response frequency	20Hz			
Residual voltage	Max. 10V			
Affection by Temp.	±10% Max. for detecting distance at +20°C within temperature range of -25 – +70°C			
Control output	5-200mA			
Insulation resistance	Min. 50MΩ (at 500VDC)			
Indicator	Operation indicator (Red LED)			
Ambient temperature	-25 to +70°C (at non-freezing status)			
Protection Circuit	Surge protection circuit			

## AUTO DOOR SENSOR



### Auto Door Sensor

Code	ADS-A
Supply Voltage	24-240VAC
Relay Output	0.1A @ 50VDC
Mounting Height	2-2.7m (max. detecting distance: 3m)
Output Delay Time	2/7/15 sec selectable by dip switch
Detection	Four angles for front detection area, 7.5°, 14.5°, 21.5°, 28.5° Right/Left detection area elimination function

Also see page 397

# MAGNETIC PROXIMITY SWITCHES IP67

## Reed Contact Magnetic Switches

(Cable length 2m)



## Nickel Plated Brass Housing

Diameter/Length	Code N/O	Amps		Code N/O+N/C	Amps		Code N/O	Amps		Code N/O+N/C	Amps	
		30VDC	250VDC		30VDC	250VDC		30VDC	250VDC		30VDC	250VDC
12 40mm	-	-	-	SM08	0.1A	0.01A	SM09	1.6A	0.2A	-	-	-
12 70mm	-	-	-	-	-	-	SM13	3A	0.4A	SM14	3A	0.4A
18 70mm	-	-	-	-	-	-	SM17	3A	0.4A	SM18	2A	0.25A

## Plastic Housing

Diameter/Length	N/O	N/O+N/C		N/O	Bistable N/O	
12 100mm	SM19	1.6A	0.2A	-	SM21	3A 0.4A
					SM22	3A 0.4A

## Specifications

- Max Voltage: 230VAC
- Switching Frequency: 200Hz
- Delay on Activation: 2mS
- Repeatability:  $\pm 0.3$ mm
- Temperature Limits: -20°C to 60°C
- Cable section (N/O): 2 x 0.50mm<sup>2</sup>
- Cable section (N/O N/C): 3 x 0.50mm<sup>2</sup>

## Wiring Diagrams

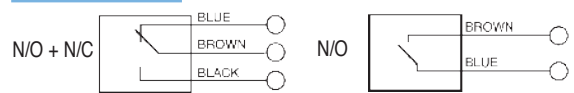

## Reed Contact Switch / Magnet Switching distances (mm)

Code	MG01		MG02		MG03		MG04		MG05	
	Distance	Hysteresis	Distance	Hysteresis	Distance	Hysteresis	Distance	Hysteresis	Distance	Hysteresis
Diameter 12 (L=40mm)	24	5	22	5	6	2.5	22	9	20	9
Diameter 12 (L=70mm)	12	7	10	6	-	-	22	9	20	9
Diameter 18	12	7	10	6	-	-	22	9	20	9

**Warning:** The data specified in this table has an **approximate** value because it depends on the magnet position, the material on which it is applied (ferromagnetic or not) and because it is related to the magnet during the frontal approach. Reed contact sensors can also be activated laterally considering that switching distances are always influenced by the magnet position, orientation and the material on which it is applied (ferromagnetic or not).

## Magnets Dimensions (mm)

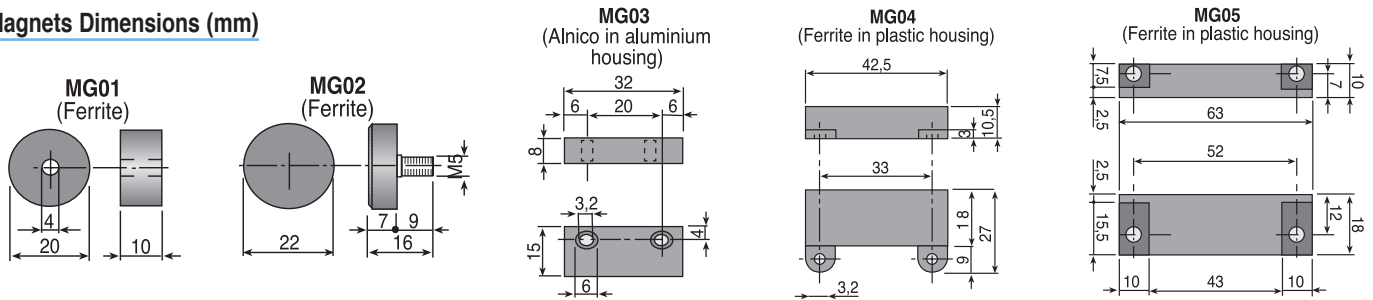

## Omnipolar & Gear Wheel Series Proximity Magnetic Sensors - IP65



Omnipolar Series		Gear Wheel Series	
M12	M18	M12	M18
Metal Body - PNP + NPN NO Cable			
BZ0112-PNNO*	BZ0118-PNNO*	BZ3112-PNNO*	BZ3118-PNNO*
Plastic Body - PNP + NPN NO Cable			
BZ0212-PNNO*	BZ0218-PNNO*	-	-

\*For M12 plug type add 5 to code e.g. BZ0112-PNNO5

## Specifications

- Voltage: 10-30VDC
- Maximum Load: 250mA
- Switching Frequency: 10 kHz
- Rising Time: 1 us
- Falling Time: 1.8 us
- Cable: 4 x 0.35mm
- Max Working Air Gap for Gear Wheel Series: 3.5mm



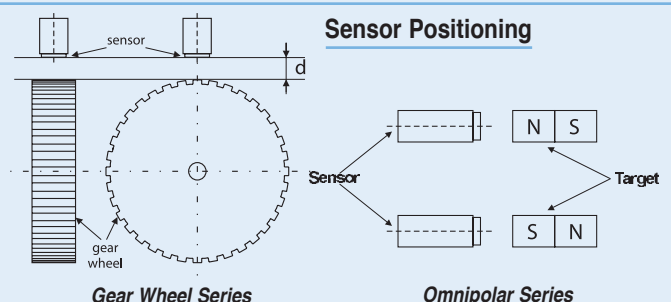
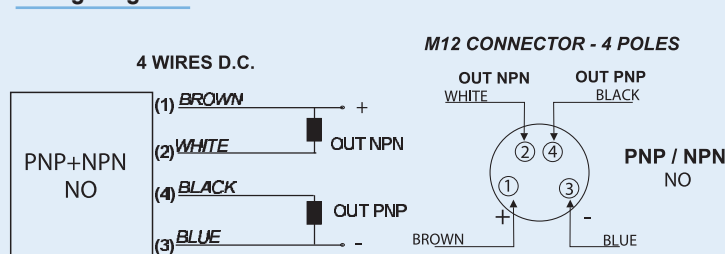

## Wiring Diagrams



LIMIT & PRESSURE SWITCHES & SENSORS





## SQUARE INDUCTIVE/CAPACITIVE PROXIMITY SWITCHES IP67

	Inductive 40x40mm		Capacitive - 40x40mm		Inductive 80x80mm	Inductive 8x8mm	
<ul style="list-style-type: none"> <li>• PBT (resin) or Nickel-plated Brass Housing</li> <li>• Operating Distance 1.5 ... 50mm</li> <li>• Cable, M8/M12 Connector or Terminal Block</li> <li>• 2 or 3 Wires</li> <li>• PNP, PNP/NPN, NO, NC, NO/NC</li> </ul>	 <p>Short Housing M12 Plug*</p>		 <p>NEW SCA</p>		 <p>SCA</p>		
Available	Shielded	Not Shielded	Shielded	Not Shielded	Not Shielded	-	-
Switching Distance (Sn)	15mm	30mm	15mm	30mm	30mm	50mm	1.5mm
Operating Voltage	10-30VDC		20-250 VAC/DC		10-30VDC	12-48VDC	10-30VDC
Max Output Current	200mA		200mA		200mA	200mA	200mA
Operation LED	Yes		Yes		Yes	-	Yellow
Switching Frequency	100Hz		25Hz AC; 40Hz Dc Terminal		-	100Hz	500Hz
Connection	M12 Plug*, Terminal Block		Block		Terminal	Cable	*M8 Plug, Cable
<b>OUTPUT:</b>							
PNP NO	-	-	-	-	-	-	IS-88-Q1-03*
NPN NO + NC	IS-40-W6-03	IS-40-Y6-03	-	-	-	AS80-50DN3	-
NPN NO + NC Short Housing M12 Plug*	IS-40-X6-S2	-	-	-	-	-	-
PNP NO + NC	IS-40-W5-03	IS-40-Y5-03	-	-	CQP2-4030P-54U	AS80-50P3	-
PNP NO + NC Short Housing M12 Plug*	IS-40-X5-S2	-	-	-	-	-	-
2 Wires AC/DC NO	-	-	IS-40-W7-03	IS-40-Y7-03	-	-	-
2 Wires AC/DC NC	-	-	IS-40-W8-03	IS-40-Y8-03	-	-	-

\*For M8 plug type replace 03 with S1 e.g. IS-88-Q1-S1 For sensor cable and accessories see pages 68-71

## 20-250VAC INDUCTIVE PROXIMITY SWITCHES IP67

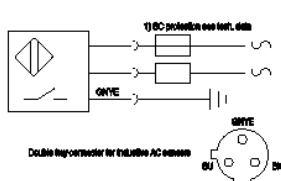
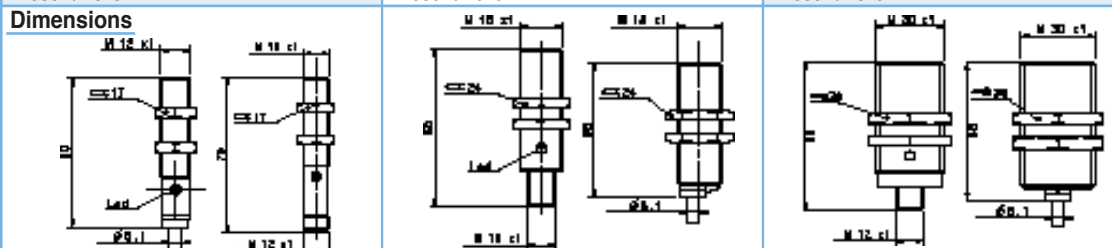
Diameter	Ø12	Ø18	Ø30
● Shielded	●	●	●
<ul style="list-style-type: none"> <li>• Nominal Voltage 20-250VAC</li> <li>• Output NO</li> <li>• Output Current 500mA Max</li> <li>• Housing Material Nickel Plated Brass</li> <li>• Cable Length 2m</li> </ul>			
Sensing Distance	2mm	5mm	10mm
VAC Supply Voltage	20-250VAC	20-250VAC	20-250VAC
Max Output Current	500mA	500mA	500mA
Switching Frequency	25Hz	25Hz	25Hz
Connection	Cable 2m, M12 Double key connector	Cable 2m, M12 Double key connector	Cable 2m, M12 Double key connector
Operation LED	Present Yellow	Present Yellow	Present Yellow
<b>Wiring Diagrams</b>			
<b>Dimensions</b>			
NO Cable Version	IS-12-A15-03	IS-18-A15-03	IS-30-A15-03
NO M12 Double Key Connector	IS-12-A15-S2	IS-18-A15-S2	IS-30-A15-S2

For M12 Double key plug connector and cable use part number CS-A1-21-R-03/05 (03=3m Cable, 05=5m Cable)

## DC SENSOR TESTER

For M12 Connector, Cable & Terminal DC Sensors



Code	Description
ST-02	<ul style="list-style-type: none"> <li>• PNP (sourcing) and NPN (sinking) Testing</li> <li>• M12-5-Pin Plug Input</li> <li>• Terminal Inputs</li> <li>• Two Output LED's</li> <li>• Battery Powered</li> </ul>

## 24-250VAC/VDC INDUCTIVE PROXIMITY SWITCHES NO OR NC IP67

Diameter	Ø 12				Ø 18				Ø 30			
● Shielded ○ Non Shielded	●	○	●	○	●	○	●	○	●	○	●	○
• Current output 200mA max   												
Switching Distance	2mm	4mm	4mm	8mm	5mm	8mm	8mm	16mm	10mm	16mm	15mm	25mm
Nominal Voltage	20-250VAC/VDC				20-250VAC/VDC				20-250VAC/VDC			
Max Output Current	200mA				200mA				200mA			
Switching Frequency	25Hz AC/ 35Hz DC				25Hz AC/ 35Hz DC				25Hz AC/ 35Hz DC			
Operating Temperature	-25°C to 75°C				-25°C to 75°C				-25°C to 75°C			
Sensing Face	PBT				PBT				PBT			
Housing	Nickel Plated Brass				Nickel Plated Brass				Nickel Plated Brass			
Connection	Cable 2m, M12 Plug				Cable 2m, M12 Plug				Cable 2m, M12 Plug			
Operation LED	Present				Present				Present			
<b>Wiring Diagram</b> 	<b>Dimensions</b> 											
NO Output (Cable Type)	IPS12-S2U060*-A2P		IPS12-N4U060*-A2P		IPS18-S5U055**-A2P		IPS18-N8U055**-A2P		IPS30-S10U055**-A2P		IPS30-N15U055**-A2P	
Double Sensing	IPS12-S4U060*-A2P		IPS12-N8U060*-A2P		IPS18-S8U055**-A2P		IPS18-N16U055**-A2P		IPS30-S16U055**-A2P		IPS30-N25U055**-A2P	
NC Output (Cable Type)	IPS12-S2UC60*-A2P		IPS12-N4UC60*-A2P		IPS18-S5UC55**-A2P		IPS18-N8UC55**-A2P		IPS30-S10UC55**-A2P		IPS30-N15UC55**-A2P	
Double Sensing	IPS12-S4UC60*-A2P		IPS12-N8UC60*-A2P		IPS18-S8UC55**-A2P		IPS18-N16UC55**-A2P		IPS30-S16UC55**-A2P		IPS30-N25UC55**-A2P	





\*For plug type replace 0-A2P with 8-A12 For sensor cable and accessories see pages 68-71

\*\*For plug type replace 55-A2P with 79-A12

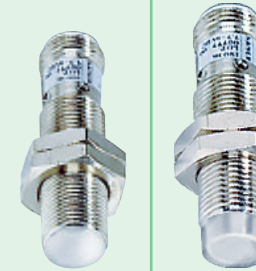

## ANALOG INDUCTIVE PROXIMITY SWITCHES IP67

Diameter	Ø 12		Ø 18		Ø 30	
● Shielded ○ Non Shielded	●	○	●	○	●	○
Measuring Distance	0.6-6mm	3.1-10mm	3.1-10mm	7.3-20mm	7.3-20mm	17.6-40mm
Nominal Voltage	18-30VDC		18-30VDC		18-30VDC	
Load Resistor	V: > 2 kOhm, A: 400 Ohm		V: > 2 kOhm, A: 400 Ohm		V: > 2 kOhm, A: 400 Ohm	
Output Following Frequency	100Hz		100Hz		100Hz	
Operating Temperature	0°C to 70°C		0°C to 70°C		0°C to 70°C	
Sensing Face	PBT		PBT		PBT	
Housing	Nickel Plated Brass		Nickel Plated Brass		Nickel Plated Brass	
Connection	Cable 2m		Cable 2m		Cable 2m	
<b>Wiring Diagram</b> 	<b>Dimensions</b> 					
Voltage 0-10V	IA12-S6V010-2NP		IA12-N6V010-2NP		IA18-S10V010-2NP	
Current 4-20mA	IA12-S6I420-2NP		IA12-N6I420-2NP		IA18-S10I420-2NP	
					IA18-N20V010-2NP	
					IA18-N20I420-2NP	
					IA30-S20V010-2NP	
					IA30-N40V010-2NP	
					IA30-S20I420-2NP	
					IA30-N40I420-2NP	

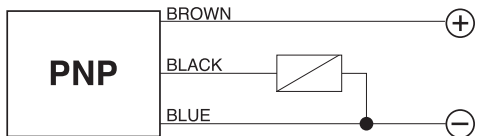
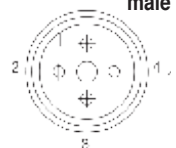
## SPECIAL DC INDUCTIVE PROXIMITY SWITCHES IP67

	Weld Field Immune				Metal Face																	
	Ø12		Ø18		Ø12		Ø18															
Diameter																						
● Shielded ○ Non Shielded	●	○	●	○	●	○	●	○														
<ul style="list-style-type: none"> <li>• Nominal Voltage: 10-30VDC</li> <li>• Max. Output Current: 200mA</li> <li>• Temp. Range: -25 to 70°C</li> <li>• Housing Material: Stainless Steel</li> <li>• Weld field immune is intrinsically safe and used in welding bays.</li> </ul>																						
<b>CE</b>																						
Switching Distance	2mm	4mm	5mm	8mm	2mm	4mm	5mm	8mm														
Operation LED	Present		Present		Present		Present															
Switching Frequency	2000Hz	1000Hz	1000Hz	500Hz	2000Hz	1000Hz	1000Hz	500Hz														
Active Face Material	ETFE		ETFE		Stainless Steel		Stainless Steel															
<b>Wiring Diagrams</b>	<div style="display: flex; justify-content: space-between; align-items: flex-start;"> <div style="width: 30%;"> <p><b>PNP</b></p>  </div> <div style="width: 30%; text-align: center;"> <p>View of quadripole male connector M12</p>  </div> <div style="width: 30%;"> <p><b>Configuration of Contacts</b></p> <table border="1" style="border-collapse: collapse; text-align: center;"> <thead> <tr> <th rowspan="2">Available</th> <th colspan="4">N. contacts</th> </tr> <tr> <th>1</th><th>2</th><th>3</th><th>4</th> </tr> </thead> <tbody> <tr> <td>NO</td> <td>+</td><td></td><td>-</td><td>no</td> </tr> </tbody> </table> </div> </div>								Available	N. contacts				1	2	3	4	NO	+		-	no
Available	N. contacts																					
	1	2	3	4																		
NO	+		-	no																		
<b>OUTPUT:</b>																						
<b>PNP NO M12 Plug</b>	IS-F12-S1-S2	IS-F12-T1-S2	IS-F18-S1-S2	IS-F18-T1-S2	IS-12-I1-S2	IS-12-L1-S2	IS-18-I1-S2	IS-18-L1-S2														

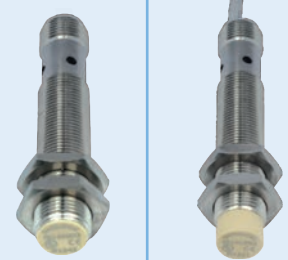
## DC 2 WIRE INDUCTIVE PROXIMITY SWITCHES IP67

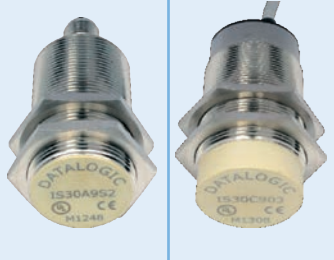
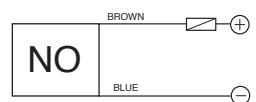
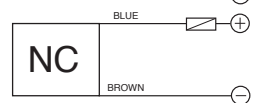
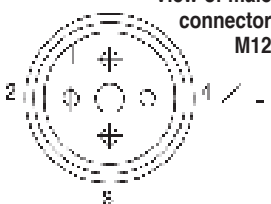
	DC Ø12		DC Ø18		DC Ø30																				
	Diameter																								
● Shielded ○ Non Shielded	●	○	●	○	●	○																			
<ul style="list-style-type: none"> <li>• Nominal Voltage: 10-30VDC</li> <li>• Max. Output Current: 100mA</li> <li>• Residual Current: 1.6mA</li> <li>• Temperature Range: -25 to 70°C</li> <li>• Housing Material: Nickel Plated Brass</li> <li>• Cost Effective</li> </ul>																									
<b>CE</b>																									
Switching Distance	2mm	4mm	5mm	8mm	10mm	15mm																			
Operation LED	Yellow		Yellow		Yellow																				
Switching Frequency	200Hz		200Hz		250Hz																				
Cable Length	2m		2m		2m																				
<b>Wiring Diagrams</b>	<div style="display: flex; justify-content: space-between; align-items: flex-start;"> <div style="width: 30%;"> <p><b>NO</b></p>  <p><b>NC</b></p>  </div> <div style="width: 30%; text-align: center;"> <p>View of male connector M12</p>  </div> <div style="width: 30%;"> <p><b>Configuration of Contacts</b></p> <table border="1" style="border-collapse: collapse; text-align: center;"> <thead> <tr> <th rowspan="2">Available</th> <th colspan="4">N. contacts</th> </tr> <tr> <th>1</th><th>2</th><th>3</th><th>4</th> </tr> </thead> <tbody> <tr> <td>NO</td> <td>+</td><td></td><td>-</td><td></td> </tr> <tr> <td>NC</td> <td>-</td><td></td><td>+</td><td></td> </tr> </tbody> </table> </div> </div>						Available	N. contacts				1	2	3	4	NO	+		-		NC	-		+	
Available	N. contacts																								
	1	2	3	4																					
NO	+		-																						
NC	-		+																						
<b>OUTPUT:</b>																									
NO-NC programmable (Cable Type)	IS-12-A9-03	IS-12-C9-03	IS-18-A9-03	IS-18-C9-03	IS-30-A9-03	IS-30-C9-03																			
NO-NC programmable (M12 connector)	IS-12-A9-S2	IS-12-C9-S2	IS-18-A9-S2	IS-18-C9-S2	IS-30-A9-S2	IS-30-C9-S2																			



# DC INDUCTIVE PROXIMITY SWITCHES STANDARD & SHORT »

Diameter	NPN or PNP	Ø5	DC	Ø6.5	DC	Ø8								
● Shielded ○ Non Shielded		●	●	○		●								
<ul style="list-style-type: none"> <li>Nominal Voltage 10-30VDC</li> <li>4 Wire programming type</li> <li>3 Wire plug and cable type</li> <li>Standard &amp; Short Housing versions</li> </ul> <p><b>For Sensor Cable &amp; Accessories see pages 68-71</b></p>														
<b>CE</b>														
Nominal Switching Distance (Sn)	0.8mm		1.5mm	2mm		2mm								
Max. Output Current	100mA		200mA			200mA								
Operation LED	Present		Present			Present (Yellow)								
Switching Frequency	2000Hz		1000Hz			1000Hz								
Temperature Limits	-25 to 60°C		-25 to 70°C			-20 to 60°C								
Cable Length	2m		2m			2m								
Housing Material	Stainless Steel		Nickel-plated brass			Nickel plated brass								
<b>View of male connector M12</b>	<b>Wiring Diagrams</b> <i>*For plug type M8 change '03' to 'S1' e.g. IS-65-A3-S1</i>			<i>*For plug type M12 change 'S1' to 'S2' e.g. IS-08-G3-S2</i>										
	<p><b>CONTACTS CONFIGURATION</b></p> <table border="1"> <thead> <tr> <th>Available</th> <th>1 BROWN</th> <th>3 BLUE</th> <th>4 BLACK</th> </tr> </thead> <tbody> <tr> <td>NPN/PNP</td> <td>+</td> <td>-</td> <td>NONC</td> </tr> </tbody> </table> <p><i>View of tripole male connector</i></p>			Available	1 BROWN	3 BLUE	4 BLACK	NPN/PNP	+	-	NONC	<p><b>3 wire sensors</b></p>		
Available	1 BROWN	3 BLUE	4 BLACK											
NPN/PNP	+	-	NONC											
<b>OUTPUT:</b>														
NPN & PNP, (NO & NC) Cable type (4 Wire)	-		-	-		<b>Cable Type</b>	<b>M8 Plug Type</b>							
NPN & PNP, (NO & NC) M12 connector (4 Wire)	-		-	-										
PNP NO output (3 Wire)	IS-05-A1-03*		IS-65-A1-03*	IS-65-C1-03*		IS-08-G1-03	IS-08-G1-S1*							
PNP NC output (3 Wire)	-		IS-65-A2-03*	IS-65-C2-03*		IS-08-G2-03	IS-08-G2-S1*							
NPN NO output (3 Wire)	IS-05-A3-03*		IS-65-A3-03*	IS-65-C3-03*		IS-08-G3-03	IS-08-G3-S1*							
NPN NC output (3 Wire)	-		IS-65-A4-03*	IS-65-C4-03*		IS-08-G4-03	IS-08-G4-S1*							

# NAMUR INDUCTIVE PROXIMITY SWITCHES IP67

Diameter	DC Ø8		DC Ø12		DC Ø18		DC Ø30															
● Shielded ○ Non Shielded	●	○	●	○	●	○	●	○														
<b>CE</b>																						
Switching Distance (± 20%)	1mm	2mm	2mm	4mm	5mm	8mm	10mm	15mm														
Nominal Voltage (Load Resistance 1K)	7.7-9VDC		7.7-9VDC		7.7-9VDC		7.7-9VDC															
Supply Voltage	5-24VDC		5-24VDC		5-24VDC		5-24VDC															
Switching Frequency	2000Hz		2000Hz		1000Hz		500Hz															
Cable	IS-08-A20-03	IS-08-C20-03	IS-12-A20-03	IS-12-C20-03	IS-18-A20-03	IS-18-C20-03	IS-30-A20-03	IS-30-C20-03														
Plug-in (M12 Connector)	IS-08-A20-S2	IS-08-C20-S2	IS-12-A20-S2	IS-12-C20-S2	IS-18-A20-S2	IS-18-C20-S2	IS-30-A20-S2	IS-30-C20-S2														
NPN NO-NC	-	-	-	-	-	-	-	-														
PNP NO-NC	-	-	-	-	-	-	-	-														
Relay Output: 18 to 240VAC/DC	-	-	-	-	-	-	-	-														
<b>Wiring Diagrams</b>	<p><b>View of male connector M12</b></p>				<p><b>Configuration of Contacts</b></p> <table border="1"> <thead> <tr> <th rowspan="2">Available</th> <th colspan="4">N. contacts</th> </tr> <tr> <th>1</th> <th>2</th> <th>3</th> <th>4</th> </tr> </thead> <tbody> <tr> <td>NAMUR</td> <td>+</td> <td>-</td> <td>-</td> <td>-</td> </tr> </tbody> </table>				Available	N. contacts				1	2	3	4	NAMUR	+	-	-	-
Available	N. contacts																					
	1	2	3	4																		
NAMUR	+	-	-	-																		
<b>For Sensor Cable &amp; Accessories see pages 68-71</b>																						
<b>Note:</b> Can only be used with AC/DC NAMUR Relay "NS1" or instruments with NAMUR inputs																						

LIMIT & PRESSURE SWITCHES & SENSORS

» HOUSING 3 WIRE OR 4 WIRE PROGRAMMABLE OUTPUT IP67

DC Ø12				DC Ø18				DC Ø30			
2mm	4mm	4mm	8mm	5mm	8mm	8mm	14mm	10mm	15mm	15mm	20mm
200mA				200mA				200mA			
Present (Yellow)				Present (Yellow)				Present (Yellow)			
1000Hz				1000Hz				300Hz			
-25 to 70°C				-25 to 70°C				-25 to 70°C			
2m				2m				2m			
Nickel plated brass				Nickel plated brass				Nickel plated brass			

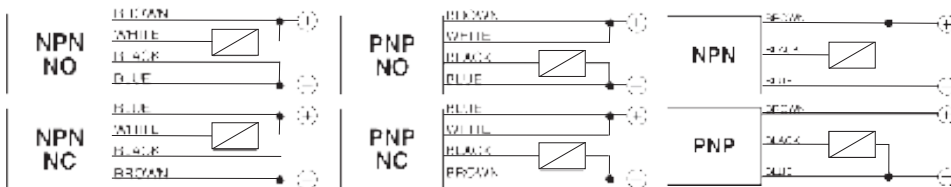

\*For plug type M12 change '03' to 'S2' e.g. IS-12-A3-S2

Housing Lengths (mm)

	Standard				Short			
	Connector		Cable		Connector		Cable	
	SH	NS	SH	NS	SH	NS	SH	NS
M12	68	72	58	64	48	54	42	48
M18	73	82	70	78	56	65	47	56
M30	74	85	70	82	56	68	49	56

IS-12-A0-03	IS-12-E0-03	IS-12-C0-03	IS-12-F0-03	IS-18-A0-03	IS-18-E0-03	IS-18-C0-03	IS-18-F0-03	IS-30-A0-03	IS-30-E0-03	IS-30-C0-03	IS-30-F0-03
IS-12-A0-S2	IS-12-E0-S2	IS-12-C0-S2	IS-12-F0-S2	IS-18-A0-S2	IS-18-E0-S2	IS-18-C0-S2	IS-18-F0-S2	IS-30-A0-S2	IS-30-E0-S2	IS-30-C0-S2	IS-30-F0-S2
IS-12-A1-03*	IS-12-G1-03*	IS-12-C1-03*	IS-12-H1-03*	IS-18-A1-03*	IS-18-G1-03*	IS-18-C1-03*	IS-18-H1-03*	IS-30-A1-03*	IS-30-G1-03*	IS-30-C1-03*	IS-30-H1-03*
IS-12-A2-03*	IS-12-G2-03*	IS-12-C2-03*	IS-12-H2-03*	IS-18-A2-03*	IS-18-G2-03*	IS-18-C2-03*	IS-18-H2-03*	IS-30-A2-03*	IS-30-G2-03*	IS-30-C2-03*	IS-30-H2-03*
IS-12-A3-03*	IS-12-G3-03*	IS-12-C3-03*	IS-12-H3-03*	IS-18-A3-03*	IS-18-G3-03*	IS-18-C3-03*	IS-18-H3-03*	IS-30-A3-03*	IS-30-G3-03*	IS-30-C3-03*	IS-30-H3-03*
IS-12-A4-03*	IS-12-G4-03*	IS-12-C4-03*	IS-12-H4-03*	IS-18-A4-03*	IS-18-G4-03*	IS-18-C4-03*	IS-18-H4-03*	IS-30-A4-03*	IS-30-G4-03*	IS-30-C4-03*	IS-30-H4-03*

CAPACITIVE PROXIMITY SENSORS IP67

DC Ø18		DC Ø30		AC Ø30		AC Ø18/*Ø30 Available	
1-5mm	1-10mm	1-20mm	1-25mm	1-20mm	2-30mm	2-8mm	*2-20mm
-	-	-	-	-	-	-	-
12-30VDC (-15/+10%)		12-30VDC (-15/+10%)		18-230VAC/DC (-15/+10%) 50Hz		20-250VAC/DC (-15/+10%) 50Hz	
10Hz		10Hz		10Hz		25Hz (Ø18) 25Hz (Ø18)	
Standard Supply Atex Approved		Standard Supply Atex Approved		-		N/O CCM1-1808A-A3L2 CCM2-1815A-A3L2	
-		-		-		N/C CCM1-1808A-B3L2 CCM2-1815A-B3L2	
CS-07	CS-13	CS-09	CS-15	-	-	*2-20mm(Ø30)	*2-30mm(Ø30)
CS-08	CS-14	CS-10	CS-16	-	-	N/O CCM1-3020A-A3L2 CCM2-3030A-A3L2	N/C CCM1-3020A-B3L2 CCM2-3030A-B3L2
-	-	-	-	CS-31/*CS-31TE	CS-32/*CS-32TE	-	-

Ex Class II

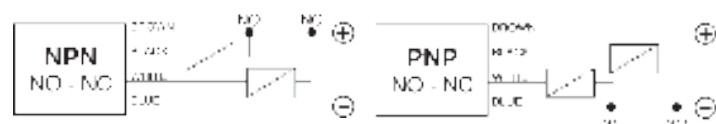

\*with 1s-5m time activating delay. Relay Output

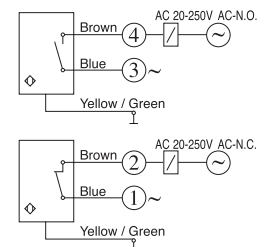
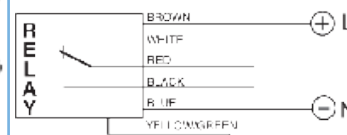

Above Capacitive Sensors are Cable type only. For Plug type units see page 68-71

## DC INDUCTIVE SENSORS

Diameter	ØM12		ØM18		ØM30		ØM40	
	● Flush	○ Surface	●	○	●	○	●	○
Sensing Distance	2mm	4mm	5mm	8mm	10mm	15mm	20mm	25mm
Supply Voltage	10 - 30VDC		10 - 30VDC		10 - 30VDC		10 - 30VDC	
Current Consumption	< 8 mA		< 8 mA		≤ 10 mA		≤ 10 mA	
Output Current	200 mA		200 mA		400 mA		400 mA	
Voltage Drop	< 1,5 V @ 200 mA		< 1,5 V @ 200 mA		≤ 2V		≤ 2V	
Switching Frequency	1000 Hz	500 Hz	300 Hz	500 Hz	100 Hz	500 Hz	1000 Hz	500 Hz
Operating Temp.	-25 to +70 °C		-25 to +70 °C		-20 to +70 °C		-20 to +70 °C	
Hysteresis	3 ...15%		3 ...15%		3 ...15%		3 ...15%	
Cable length	2 meters, PVC		2 meters, PVC		2 meters, PVC		2 meters, PVC	
Cable section	3 Wire		3 Wire		3 Wire, 4 Wire(NX)		3 Wire, 4 Wire(NX)	
Housing Material	Nickel Plated Brass		Nickel Plated Brass		Aluminium		Aluminium	

### Wiring Diagram

#### 3 Wire sensors

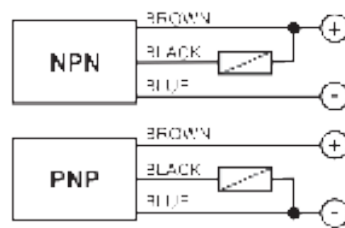

#### 3 and 4 Wire (NX) sensors

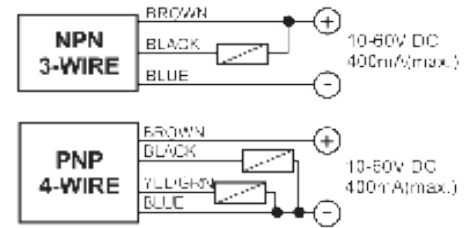

For Sensor Cables see pages 68-71

	Flush	Surface	Flush	Surface	Flush	Surface	Flush	Surface
PNP NO, Cable	IS4-1202F-NOMTC	IS4-1204S-NOMTC	IS4-1805F-NOMTC	IS4-1808S-NOMTC	RI4-3010F-NOMTC	RI4-3015S-NOMTC	RI4-4020F-NOMTC	RI4-4025S-NOMTC
PNP NC, Cable	IS4-1202F-NCMTC	IS4-1204S-NCMTC	IS4-1805F-NCMTC	IS4-1808S-NCMTC	RI4-3010F-NCMTC	RI4-3015S-NCMTC	RI4-4020F-NCMTC	RI4-4025S-NCMTC
PNP NO/NC, Cable	RI4-1202F-NXMTC	RI4-1204S-NXMTC	RI4-1805F-NXMTC	RI4-1808S-NXMTC	RI4-3010F-NXMTC	RI4-3015S-NXMTC	RI4-4020F-NXMTC	RI4-4025S-NXMTC
PNP NO, Plug	IS4-1202F-NOMTP	IS4-1204S-NOMTP	IS4-1805F-NOMTP	IS4-1808S-NOMTP	RI4-3010F-NOMTP	RI4-3015S-NOMTP	-	-
PNP NC, Plug	IS4-1202F-NCMTP	IS4-1204S-NCMTP	IS4-1805F-NCMTP	IS4-1808S-NCMTP	RI4-3010F-NCMTP	RI4-3015S-NCMTP	-	-
PNP NO/NC, Plug	RI4-1202F-NXMTP	RI4-1204S-NXMTP	RI4-1805F-NXMTP	RI4-1808S-NXMTP	RI4-3010F-NXMTP	RI4-3015S-NXMTP	-	-
NPN NO, Cable	IS5-1202F-NOMTC	IS5-1204S-NOMTC	IS5-1805F-NOMTC	IS5-1808S-NOMTC	RI5-3010F-NOMTC	RI5-3015S-NOMTC	RI5-4020F-NOMTC	RI5-4025S-NOMTC
NPN NC, Cable	IS5-1202F-NCMTC	IS5-1204S-NCMTC	IS5-1805F-NCMTC	IS5-1808S-NCMTC	RI5-3010F-NCMTC	RI5-3015S-NCMTC	RI5-4020F-NCMTC	RI5-4025S-NCMTC
NPN NO/NC, Cable	RI5-1202F-NXMTC	RI5-1204S-NXMTC	RI5-1805F-NXMTC	RI5-1808S-NXMTC	RI5-3010F-NXMTC	RI5-3015S-NXMTC	RI5-4020F-NXMTC	RI5-4025S-NXMTC
NPN NO, Plug	IS5-1202F-NOMTP	IS5-1204S-NOMTP	IS5-1805F-NOMTP	IS5-1808S-NOMTP	RI5-3010F-NOMTP	RI5-3015S-NOMTP	-	-
NPN NC, Plug	IS5-1202F-NCMTP	IS5-1204S-NCMTP	IS5-1805F-NCMTP	IS5-1808S-NCMTP	RI5-3010F-NCMTP	RI5-3015S-NCMTP	-	-
NPN NO/NC, Plug	RI5-1202F-NXMTP	RI5-1204S-NXMTP	RI5-1805F-NXMTP	RI5-1808S-NXMTP	RI5-3010F-NXMTP	RI5-3015S-NXMTP	-	-

### Intelligent Canline Sensor IP67



The Intelligent Can Line Sensor has been specifically designed and developed for detecting the presence and movement of cans and automated can making and can filling lines. When interfaced with Programmable Logic Controller (PLC) the sensor's integrated intelligence released the PLC from time-consuming computing activities.

The Can Line Sensor is versatile enough to be used in a variety of applications.









- Some of these are:
- Gap-detection (missing cans)
  - Pile-up detection
  - Proximity and motion detection
  - Built-back control
  - Detection of missing tops or crowns on bottling lines

Code	Description
RI4-9020F-NOPBC	PNP, N.O., c/w Fly Lead
RI4-9020F-NOPBP	PNP, N.O., c/w M.Plug
RI5-9020F-NOPBC	NPN, N.O., c/w Fly Lead
RI5-9020F-NOPBP	NPN, N.O., c/w M.Plug

CAN MATERIAL	Sn
Mild Steel	20
Stainless Steel	15
Aluminium	8



## NAMUR INDUCTIVE & CAPACITIVE SENSORS IP68 (DIN 19234)

Diameter	ØM12		ØM18		ØM30		ØM40	
● Flush ○ Surface	●	○	●	○	●	○	●	○
								
Sensing Distance	2mm	4mm	5mm	8mm	10mm	15mm	20mm	25mm
Supply Voltage	8,2 - 10VDC (via module)		8,2 - 10VDC (via module)		8,2 - 10VDC (via module)		8,2 - 10VDC (via module)	
Current Consumption	≤ 2 mA		≤ 2 mA		≤ 2 mA		≤ 2 mA	
Output Current (Metal Present)	0,8mA Typical		0,8mA Typical		0,8mA Typical		0,8mA Typical	
Output Current (Metal Absent)	4mA Typical		4mA Typical		4mA Typical		4mA Typical	
Switching Frequency	2000Hz		1000Hz		500Hz		500Hz	
Operating Temp.	-20 to +70 °C		-20 to +70 °C		-20 to +70 °C		-20 to +70 °C	
Hysteresis	3 to 15%		3 to 15%		3 to 15%		3 to 15%	
Cable Length	2m		2m		2m		2m	
Cable Section	2 Wire		2 Wire		2 Wire		2 Wire	
Housing Material	Aluminium		Aluminium		Aluminium		Aluminium	

For Sensor Cables see pages 68-71

**Wiring Diagram**

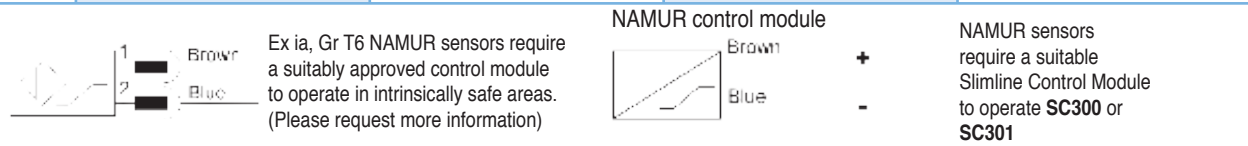









**OUTPUT:**

	Flush	Surface	Flush	Surface	Flush	Surface	Flush	Surface
NAMUR NC, Cable								
NAMUR NC, Plug	RI0-1202F-NCMTC	RI0-1204S-NCMTC	RI0-1805F-NCMTC	RI0-1808S-NCMTC	RI0-3010F-NCMTC	RI0-3015S-NCMTC	RI0-4020F-NCMTC	RI0-4025S-NCMTC
	-	-	RI0-1805F-NCMTP	RI0-1808S-NCMTP	-	-	-	-

**Capacitive NAMUR Sensors**

NC, Metal, Cable	-	-	-	-	RC0-3010F-NCMTC	RC0-3020S-NCMTC	-	-
NC, Metal, Plug	-	-	-	-	RC0-3010F-NCMTP	RC0-3020S-NCMTP	-	-

## AC INDUCTIVE SENSORS IP68

Diameter	ØM12		ØM18		ØM30		ØM40	
● Flush ○ Surface	●	○	●	○	●	○	●	○
								
Sensing Distance	2mm	4mm	5mm	8mm	10mm	15mm	20mm	25mm
Supply Voltage	20 - 250VAC		20 - 250VAC		20 - 250VAC		20 - 250VAC	
Current Consumption	≤ 2 mA		≤ 2 mA		≤ 2 mA		≤ 2 mA	
Output Current	400mA		400mA		400mA		400mA	
Switching Frequency	10Hz		10Hz		10Hz		10Hz	
Operating Temp.	-20 to +70 °C		-20 to +70 °C		-20 to +70 °C		-20 to +70 °C	
Hysteresis	3 to 15%		3 to 15%		3 to 15%		3 to 15%	
Cable Length	2m		2m		2m		2m	
Cable Section	2 Wire		2 Wire		2 Wire		2 Wire	
Housing Material	Aluminium		Aluminium		Aluminium		Aluminium	

For Sensor Cables see pages 68-71

**Wiring Diagram**

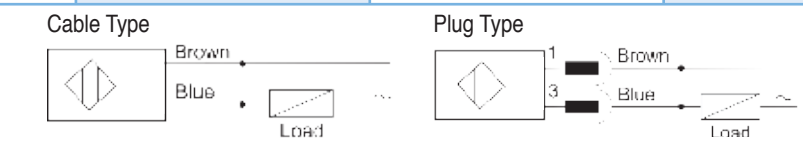

**Note:** These sensors are not protected against sustained current fault conditions. The fitting of an external inline 0, 4A fuse is therefore advised.

**OUTPUT:**

	Flush	Surface	Flush	Surface	Flush	Surface	Flush	Surface
NO, Cable	RI1-1202F-NOMTC	RI1-1204S-NOMTC	RI1-1805F-NOMTC	RI1-1808S-NOMTC	RI1-3010F-NOMTC	RI1-3015S-NOMTC	RI1-4020F-NOMTC	RI1-4025S-NOMTC
NC, Cable	RI1-1202F-NCMTC	RI1-1204S-NCMTC	RI1-1805F-NCMTC	RI1-1808S-NCMTC	RI1-3010F-NCMTC	RI1-3015S-NCMTC	RI1-4020F-NCMTC	RI1-4025S-NCMTC
NO, Plug	RI1-1202F-NOMTP	RI1-1204S-NOMTP	RI1-1805F-NOMTP	RI1-1808S-NOMTP	RI1-3010F-NOMTP	RI1-3015S-NOMTP	-	-
NC, Plug	RI1-1202F-NCMTP	RI1-1204S-NCMTP	RI1-1805F-NCMTP	RI1-1808S-NCMTP	RI1-3010F-NCMTP	RI1-3015S-NCMTP	-	-

## CAPACITIVE SENSORS IP67

Diameter	ØM12		ØM18		ØM30		1,5 "BSP	
● Flush ○ Surface	●	○	●	○	●	○	○	
Sensing Distance	4mm	8mm	8mm	15mm	20mm	30mm	20mm	
Supply Voltage	10 - 30VDC		10 - 30VDC		10 - 30VDC		20-250VAC 50/60Hz	10-60VDC
Current Consumption	<9 mA		<9 mA		<9 mA		2.5 mA	10mA
Output Current	200 mA		200 mA		200 mA		400mA (min 10mA)	400mA
Voltage Drop	2 V @ 200 mA		2 V @ 200 mA		2 V @ 200 mA		2 V @ 200 mA	2V @ 200mA
Adjustment	Multi-turn Pot		Multi-turn Pot		Multi-turn Pot		Multi-turn Pot	Multi-turn Pot
Switching Frequency	100 Hz		100 Hz		100 Hz		10 Hz	80 Hz
Operating Temp.	-25 to +70 °C		-25 to +70 °C		-25 to +70 °C		-10 to +65 °C	-10 to +65°C
Hysteresis	< 4 %		< 4 %		< 4 %		< 5 %	< 5 %
Cable Length	2 meters, PVC		2 meters, PVC		2 meters, PVC		Terminal	Terminal
Cable Section	3 wire		2 wire or 3 wire		2 wire or 3 wire		Connection	Connection
Housing Material	Nickel Plated Brass		Nickel Plated Brass		Nickel Plated Brass		PVC	PVC

**For Sensor Cables see pages 68-71**

### Wiring Diagram 3 Wire Sensors

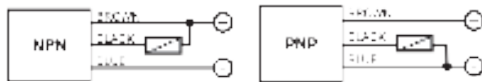

### OUTPUT:

DC Sensors	Flush	Surface	Flush	Surface	Flush	Surface
PNP NO, Plug	CS4-1204F-NOMTP	CS4-1208S-NOMTP	CS4-1808F-NOMTP	CS4-1815S-NOMTP	CS4-3020F-NOMTP	CS4-3030S-NOMTP
PNP NC, Plug	CS4-1204F-NCMTP	CS4-1208S-NCMTP	CS4-1808F-NCMTP	CS4-1815S-NCMTP	CS4-3020F-NCMTP	CS4-3030S-NCMTP
NPN NO, Plug	CS5-1204F-NOMTP	CS5-1208S-NOMTP	CS5-1808F-NOMTP	CS5-1815S-NOMTP	CS5-3020F-NOMTP	CS5-3030S-NOMTP
NPN NC, Plug	CS5-1204F-NCMTP	CS5-1208S-NCMTP	CS5-1808F-NCMTP	CS5-1815S-NCMTP	CS5-3020F-NCMTP	CS5-3030S-NCMTP

### AC Sensors

2 Wire NO Cable 20-250VAC	-	-	CS1-1808F-NOMTC	CS1-1815S-NOMTC	CS1-3020F-NOMTC	CS1-3030S-NOMTC
2 Wire NC Cable 20-250VAC	-	-	CS1-1808F-NCMTC	CS1-1815S-NCMTC	CS1-3020F-NCMTC	CS1-3030S-NCMTC

## OPTO ELECTRONIC SENSORS

Type	Opto - Proximity	Opto - Barrier Sets		Opto - Fork Sensor
	<b>IP66</b> 	<b>IP66</b> 	<b>IP67</b> 	<b>IP67</b> 
Sensing Distance	2m	10m	5m	3.5mm
Supply Voltage	Select control voltage when ordering <b>SC410 / SC411</b> control relay			
Setting	Sensitivity Trimmer	Sensitivity Trimmer		Sensitivity Trimmer
Output Current	-	-	-	400mA
Current Consumption	-	-	-	< 10mA
Voltage Drop	-	-	-	2V max
Operation Mode	Dark or Light	Dark or Light	Dark or Light	Dark or Light
Operating Temperature	0 - 70°C	0 - 70°C	0 - 70°C	0 - 70°C
Front Sensing	<b>RO2-5005P-NOMBC</b>	<b>RO2-5010B-NOMBC (pair)</b>	<b>RO2-1210B-NOMTC (pair)</b>	
Side Sensing	<b>RO2-2005P-NOMBC</b>	<b>RO2-2010B-NOMBC (pair)</b>		
Fork Sensing PNP				<b>RO4-2003B-NOMBC</b>
Fork Sensor PNP with remote sensitivity adjustment				<b>RO4-2503B-NOMBC</b>
<b>Separate Parts (i.e. not Tx+Rx)</b>				
Front Transmitter		<b>RO2-5010T-NOMBC</b>	<b>RO2-1210T-NOMTC</b>	
Front Receiver		<b>RO2-5010R-NOMBC</b>	<b>RO2-1210R-NOMTC</b>	
Side Transmitter		<b>RO2-2010T-NOMBC</b>		
Side Receiver		<b>RO2-2010R-NOMBC</b>		

**\*\*SC410/SC411 See pg 24**

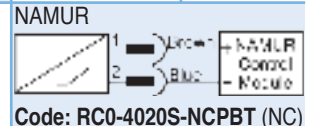

**Code: RC0-4020S-NCPBT (NC)**

AC 2 Wire  
0.4A fuse protection required



**Code: RC1-4020S-NOPBT (NO) -NCPBT (NC)**

DC PNP 3 Wire

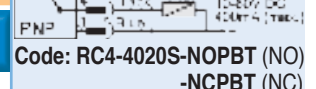

**Code: RC4-4020S-NOPBT (NO) -NCPBT (NC)**

DC PNP 3 Wire

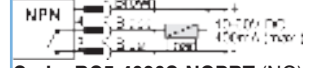

**Code: RC5-4020S-NOPBT (NO) -NCPBT (NC)**

**NAMUR**

Requires a suitable control module to operate  
**2 Wire AC**  
 Supply Voltage: 20 to 250VAC, 50/60Hz  
 Minimum Load Current: 10mA  
 Continuous Load Current: 400mA  
 Off-state Quiescent Current: ≤2,5mA at 250VAC  
 These sensors are not protected against sustained over current fault conditions. The fitting of an external inline 0,4A fuse is therefore advised.

**DC Sensors** are to be connected to a DC power supply and can switch loads (e.g. Relays, solenoids, PLC's) directly.  
 Supply Voltage: 10 to 60VDC  
 Maximum Ripple: 10%  
 Maximum Load Current: 400mA  
 Quiescent Current: <10mA  
 Polarity Protection: Yes  
 Overload Protection: Yes  
 Short Circuit Protection: Yes

## DC INDUCTIVE SPEED SENSORS IP67

Type	M30 - Cylindrical		40 x 40 - 5Way Rotatable	
	●	○	●	○
● Shielded ○ Non-Shielded • Nominal Voltage: 10-30VDC • Max. Load Current: 200mA				
<b>CE</b>				
Sensing Distance	10mm	15mm	20mm	30mm
Speed Range (1 pulse 1 turn)	6-150 targets/minute (slow). 120-3000 targets/minute (fast)		6-150 targets/minute (slow). 120-3000 targets/minute (fast)	
Power Up Delay	0.5-10sec		0.5-10sec	
Operation LED	Present		Present	
Short Circuit Protection	YES		YES	
Hysteresis	<15%		<15%	
Temperature	-25° to 70°C		-25° to 70°C	
Housing Material	Nickel Plated Brass		PBT	
<b>Wiring Diagrams</b> <i>Typical applications include under speed, locked rotor and zero speed detection for shaft, belt or web. Breakage, sequential motor starting or runout detection.</i>				
<b>OUTPUT:</b>				
PNP N.O.	FCM1-3010P-A3U2/S*	FCM2-3015P-A3U2/S*	FQP1-Q4020P-A3U/S*	FQP2-Q4030P-A3U/S*
PNP N.C.	FCM1-3010P-B3U2/S*	FCM2-3015P-B3U2/S*	FQP1-Q4020P-B3U/S*	FQP2-Q4030P-B3U/S*
NPN N.O.	FCM1-3010N-A3U2/S*	FCM2-3015N-A3U2/S*	FQP1-Q4020N-A3U/S*	FQP2-Q4030N-A3U/S*
NPN N.C.	FCM1-3010N-B3U2/S*	FCM2-3015N-B3U2/S*	FQP1-Q4020N-B3U/S*	FQP2-Q4030N-B3U/S*
*For fast speed 120-3000 targets/minute change S to F e.g FCM1-3010N-A3U2/F				

## DC INDUCTIVE MICRO PROXIMITY SWITCHES IP67

Diameter	MPS-8		MPS-10	MPS-12	MPS-15	
	○	○	○	○	○	○
○ Non-Shielded • Max. Load Current: 100mA						
<b>CE</b>						
Sensing Distance	2.5mm		3mm	3mm. 6mm(P/N)	8mm	
Supply Voltage	10-30VDC (3 wire) 10-60VDC (2 wire)		10-30VDC (3 wire) 10-60VDC (2 wire)	10-30VDC (3 wire) 10-60VDC (2 wire)	10-30VDC (3 wire) 10-60VDC (2 wire)	
Switching Frequency	1 KHZ (2 wire) 500 HZ (3 wire)		1 KHZ(2wire) 250HZ(3wire) 500HZ(6mm P/N)	1 KHZ (2 wire) 250HZ (3 wire)	1 KHZ (2 wire) 250HZ (3 wire)	
Operation LED	Present		Present	Present	Present	
Short Circuit Protection	YES		YES	YES	YES	
Temperature	-25° to 70°C		-25° to 70°C	-25° to 70°C	-25° to 70°C	
Housing Material	Polycarbonate		Polycarbonate	Polycarbonate	Polycarbonate	
Cable Length	2m		2m	2m	2m	
Dimensions (mm)	8 x 7,4 x 20	8 x 8 x 23	10 x 6 x 27	12 x 7,1 x 27	15 x 8 x 32	15 x 15 x 30
<b>Wiring Diagrams</b> DC 2-Wire      NPN Output      PNP Output						
<b>OUTPUT:</b>						
PNP NO (3 Wire)	LQP2-82.5P-AF	LQP2-82.5P-AT	LQP2-103P-AF	LQP2-123P-AF	LQP2-156.4P-AF	LQP2-156.4P-AT
PNP NC (3 Wire)	LQP2-82.5P-BF	LQP2-82.5P-BT	LQP2-103P-BF	LQP2-123P-BF	LQP2-156.4P-BF	LQP2-156.4P-BT
NPN NO (3 Wire)	LQP2-82.5N-AF	LQP2-82.5N-AT	LQP2-103N-AF	LQP2-123N-AF	LQP2-156.4N-AF	LQP2-156.4N-AT
NPN NC (3 Wire)	LQP2-82.5N-BF	LQP2-82.5N-BT	LQP2-103N-BF	LQP2-123N-BF	LQP2-156.4N-BF	LQP2-156.4N-BT
NO (2 Wire)	LQP2-82.5C-AF	LQP2-82.5C-AT	LQP2-103C-AF	LQP2-123C-AF	LQP2-156.4C-AF	LQP2-156.4C-AT
NC (2 Wire)	LQP2-82.5C-BF	LQP2-82.5C-BT	LQP2-103C-BF	LQP2-123C-BF	LQP2-156.4C-BF	LQP2-156.4C-BT



# M12 DC PHOTOELECTRIC SENSOR PLASTIC & METAL IP67

Type DC M12 Ø12 M12 SERIES	Diffuse Proximity	Retro-Reflective		Through Beam
		Non-Polarized	Polarized	
<ul style="list-style-type: none"> <li>Nominal Voltage 10-30VDC</li> <li>Output: NPN or PNP</li> <li>Output Current: 150mA</li> <li>Housing Material: PBT (plastic v) Nickel Plated Brass (metal v)</li> <li>Temperature Range: -25 to 70°C</li> </ul>				
Sensing Distance	200mm	2m	1m	5.2m
DC Supply Voltage	10-30VDC	10-30VDC	10-30VDC	10-30Vdc
Emission	Infrared LED 880nm	Infrared LED 880nm	Red light 660nm	Infrared LED 880nm
Setting	sensitivity trimmer	sensitivity trimmer	sensitivity trimmer	sensitivity trimmer
Switching Frequency	1kHz	1kHz	1kHz	25Hz
Operation Mode	Light-ON / Dark-ON selectable^	Light-ON / Dark-ON selectable^	Light-ON / Dark-ON selectable^	Light-ON / Dark-ON selectable^

### Wiring Diagrams

#### NPN Output Type

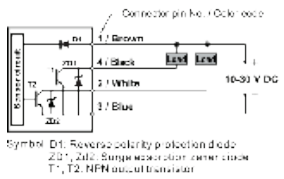

#### PNP Output Type

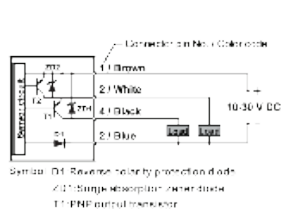

#### Emitter of Thru-beam Mode

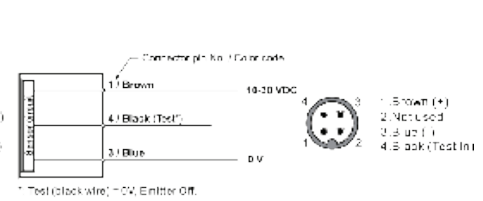

^Light/Dark changeover by the A. load or B. load

^Light/Dark changeover by the A. load or B. load

### OUTPUT:

	Metal Housing Version			Plug Type
NPN Cable Version	M12P*-D0200N-CX9C4U2**	M12P*-L2000N-CX9C4U2**	M12P*-L1000N-CX6C4U2**,-PF	M12P*-T5200N-CX9C4U2**
PNP Cable Version	M12P*-D0200P-CX9C4U2**	M12P*-L2000P-CX9C4U2**	M12P*-L1000P-CX6C4U2**,-PF	M12P*-T5200P-CX9C4U2**
Emitter Cable Version	-	-	-	M12P*-T5200D-EX9C3L2
Emitter M12 Plug Version	-	-	-	M12P*-T5200D-EX9Q4LE



\*For metal type replace P with B e.g. M12B-D0200N-CX9C4U2 \*\*For plug type replace C4U2 with Q4UE e.g. M12P-D002N-CX9Q4UE

For sensor cable and accessories see pages 68-71

# MINI BEAM PHOTOELECTRIC SENSOR IP67

Type DC MP SERIES	Diffuse Proximity	Retro-Reflective		Through Beam	
	Medium Distance	Fixed Focus	Non-Polarized	Polarized	
<ul style="list-style-type: none"> <li>Nominal Voltage 10-30VDC</li> <li>Output: NPN or PNP Configurable</li> <li>Output Current: 150mA</li> <li>Housing Material: Reinforced Thermoplastic Polyester</li> <li>Temperature Range: -25 to 70°C</li> </ul>					
Sensing Distance	380mm	16mm	0.1-5m	2m	0-3m
DC Supply Voltage	10-30VDC	10-30VDC	10-30VDC	10-30VDC	10-30VDC
Emission	Infrared LED 880nm	Infrared LED 880nm	Red light 650nm	Red light 650nm	Infrared LED 880nm
Setting	sensitivity trimmer		sensitivity trimmer	sensitivity trimmer	sensitivity trimmer
Switching Frequency**	1kHz	1kHz	1kHz	1kHz	25Hz
Operation Mode	Light-ON / Dark-ON select switch	Light-ON / Dark-ON select switch	Light-ON / Dark-ON select switch	Light-ON / Dark-ON select switch	Light-ON / Dark-ON select switch

### Pico Style Pigtail Plug Type



### Wiring Diagrams

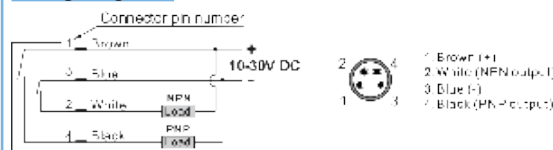

#### NPN/PNP

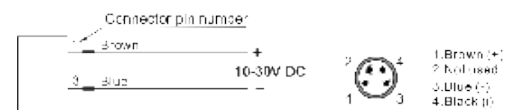

#### Emitter of Thru-beam Mode

NPN & PNP Cable Version	MP-D0380D-CX9C4U2	MP-C0016D-CX9C4U2	MP-L5000D-CX6C4U2	MP-L2000D-CX6C4U2-PF	MP-T3000*D-CX9C4U2
NPN & PNP M8 Pigtail Pico**	MP-D0380D-CX9P4UP	MP-C0016D-CX9P4UP	MP-L5000D-CX6P4UP	MP-L2000D-CX6P4UP-PF	MP-T3000*D-CX9P4UP
Emitter Cable Version	-	-	-	-	MP-T3000*D-EX9C3L2
Emitter M8 Pigtail Pico**	-	-	-	-	MP-T3000*D-EX9P4LP



\*For units with 30m sensing distance change 3000 to 030M e.g. MP-T030MD-CX9C4U2

For sensor cable and accessories see pages 68-71 \*\*High Speed Type available on request



# DC PHOTOELECTRIC SENSORS SHORT HOUSING PLASTIC >>

Type DC M18 Ø18	<b>Diffuse Proximity</b>			
<b>S15 SERIES</b>	Short Distance	Medium Distance	Long Distance	Fixed Focus
<ul style="list-style-type: none"> <li>Nominal Voltage 12-30VDC</li> <li>Output: NPN or PNP</li> <li>Output Current: ≤100mA</li> <li>Temperature Range: -25 to 55°C</li> <li>New stainless steel models</li> <li>IP67+IP69K on all models</li> <li>Johnson Diversey certification for detergents</li> <li>Atex II 3dg certification</li> </ul>				
Sensing Distance	1-10cm	1-35cm	1-100cm	1-5cm
DC Supply Voltage	12-30VDC	12-30VDC	12-30VDC	12-30VDC
Emission	Infrared LED 880nm	Infrared LED 880nm	Infrared LED 880nm	Red LED 660nm
Setting	-	Sensitivity Trimmer*	Sensitivity Trimmer*	-
Output LED	Yellow Output LED	Yellow Output LED	Yellow Output LED	Yellow Output LED
Switching Frequency	500 Hz	500 Hz	500 Hz	1Khz
Operation Mode	Light/Dark Selectable^	Light/Dark Selectable^	Light/Dark Selectable^	Light/Dark Selectable^
	<b>Dimensions</b>			
NPN Cable	S15-PA-2-C00-NK	S15-PA-2-C10-NK	-	S15-PA-2-D50-NK
PNP Cable	S15-PA-2-C00-PK	S15-PA-2-C10-PK	-	S15-PA-2-D50-PK
NPN M12 Plug	-	S15-PA-5-C11-NK	S15-PA-5-C31-NK	-
PNP M12 Plug	-	S15-PA-5-C11-PK	S15-PA-5-C31-PK	-
NPN M12 Plug Stainless Steel	-	S15-NA-5-C11-NK	S15-NA-5-C31-NK	-
PNP M12 Plug Stainless Steel	-	S15-NA-5-C11-PK	S15-NA-5-C31-PK	-

\*Sensitivity trimmer on M12 Plug Units Only For sensor cable and accessories see pages 68-71

# DC PHOTOELECTRIC SENSORS PLASTIC AND METAL IP67

Type DC M18 Ø18	<b>Diffuse Proximity</b>			
<b>S50 SERIES</b>	Short Distance	Medium Distance	Long Distance	Fixed Focus
<ul style="list-style-type: none"> <li>Nominal Voltage 10-30VDC</li> <li>Output: NPN or PNP</li> <li>Contacts: NO and NC</li> <li>Output Current: ≤100mA</li> <li>Housing Material: PBT - Lens PMMA</li> <li>Temperature Range: -25 to 55°C</li> <li>"One For All"</li> <li>Flat plastic or cylindrical metal housing</li> <li>Versions with Trimmers</li> <li>Cable or M12 Connection</li> <li>EN standard NPN or PNP NO-NC configuration</li> </ul>				
Sensing Distance	100mm	400mm	700mm	100mm
DC Supply Voltage	10-30VDC	10-30VDC	10-30VDC	10-30VDC
Emission	Red 630nm	Infrared LED 880nm	Infrared LED 880nm	Red LED 630nm
Minimum Detectable Object	-	-	-	-
Setting	-	Sensitivity trimmer	Sensitivity trimmer	-
Output LED	Yellow	Yellow/Green (stability)	Yellow/Green (stability)	Yellow
Switching Frequency	1kHz	1kHz	1kHz	1kHz
Operation Mode	Dark on NO / Light on NC	Dark on NO / light on NC	Dark on NO / Light on NC	Dark on NO / light on NC
<b>Metal Housing Version</b>	<b>Wiring Diagrams</b>			<b>M12 Connector</b>
<b>OUTPUT:</b>				
NPN NO-NC Cable	S50-P**A-2*-C10-NN	S50-P**A-2*-C21-NN	S50-P**A-2*-C01-NN	S50-P**A-2*-D00-NN
PNP NO-NC Cable	S50-P**A-2*-C10-PP	S50-P**A-2*-C21-PP	S50-P**A-2*-C01-PP	S50-P**A-2*-D00-PP
Emitter Cable	-	-	-	-

\*For plug type replace 2 with 5 e.g. S50-PA-5-B01-NN For sensor cable and accessories see pages 68-71

\*\*For metal type replace P with M e.g. S50-MA-5-C10-PK For Radial Optics 90° Sensing use DEV90 Accessory

LIMIT & PRESSURE SWITCHES & SENSORS



## AND STAINLESS STEEL PNP/NPN IP67 & IP69K ATEX II 3dg

### Retro-Reflective

Retro-Reflective				Through Beam	
Non-Polarized	Polarized	Transparents	Background Suppression	Receiver	Emitter
0.1-5m (R2 Reflector)	0.1-4m (R2 Reflector)	0.1-8m (R2 Reflector)	40-120mm	0-20m	0-20m
12-30VDC	12-30VDC	12-30VDC	12-30VDC	12-30VDC	12-30VDC
Infrared LED 880nm	Red LED 660nm	Red LED 660nm	Red LED 660nm	-	Infrared LED 880nm
Sensitivity Trimmer*	Sensitivity Trimmer*	Sensitivity Trimmer*	Sensitivity Trimmer*	Sensitivity Trimmer*	-
Yellow Output LED	Yellow Output LED	Yellow Output LED	Yellow Output LED	Yellow Output LED	Yellow Output LED
500 Hz	500 Hz	500 Hz	500 Hz	250 Hz	-
Light/Dark Selectable^	Light/Dark Selectable^	Light/Dark Selectable^	Light/Dark Selectable^	Light/Dark Selectable^	Light/Dark Selectable^

### Wiring Diagrams

#### Cable

S15...A00/B00/C00/C10/F00/D50

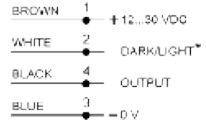

S15...G00

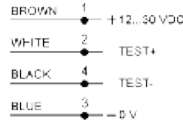

#### M12 Connector

S15...A01/B01/C11/C31/T01/F01/M01

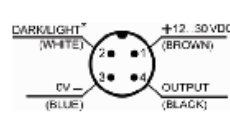

S15...G01

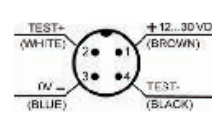

^With Light/Dark input not connected the Proximity models function in the light mode, the retroreflex and through beam models in the Dark mode. The Light mode can be selected connecting the Light/Dark input to +Vdc and the Dark mode connecting it to the 0Vdc.

S15-PA-2-A00-NK	S15-PA-2-B00-NK	-	-	S15-PA-2-F00-NK	S15-PA-2-G00-XG
S15-PA-2-A00-PK	S15-PA-2-B00-PK	-	-	S15-PA-2-F00-PK	
S15-PA-5-A01-NK	S15-PA-5-B01-NK	S15-PA-5-T01-NK	S15-PA-5-M01-NK	S15-PA-5-F01-NK	S15-PA-5-G01-XG
S15-PA-5-A01-PK	S15-PA-5-B01-PK	S15-PA-5-T01-PK	S15-PA-5-M01-PK	S15-PA-5-F01-PK	
S15-NA-5-A01-NK	S15-NA-5-B01-NK	S15-NA-5-T01-NK	-	S15-NA-5-F01-NK	S15-NA-5-G01-XG
S15-NA-5-A01-PK	S15-NA-5-B01-PK	S15-NA-5-T01-PK	-	S15-NA-5-F01-PK	

\*Sensitivity trimmer on M12 Plug Units Only For sensor cable and accessories see pages 68-71

## DC PHOTOELECTRIC SENSORS PLASTIC & METAL IP67

### Retro-Reflective

Retro-Reflective			Contrast Sensor	Through Beam
Non-Polarized	Polarized	Retroreflex for Transparents		
0.1-5m (R2,R5 reflector*)	4m (R2,R5 reflector*)	0.7-1.7m (R2,R5 reflector*)	10mm	0-20m
10-30VDC	10-30VDC	10-30VDC	10-30VDC	10-30VDC
Infrared LED 880nm	Red 660nm	Red LED 660nm	White LED 400-700nm	Infrared LED 880nm
-	-	-	0.5mm	-
-	Sensitivity trimmer	Sensitivity trimmer	Teach-in push-button	Sensitivity trimmer
Yellow	Yellow/Green (stability)	Yellow	Yellow/Green/Red Error	Yellow/Green (stability)
1kHz	1kHz	1kHz	5kHz	250kHz
Dark on NO / light on NC	Dark on NO / light on NC	Dark on NO / light on NC	Dark with EASYtouch™	Dark on NO / light on NC

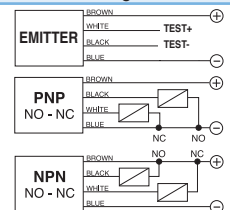
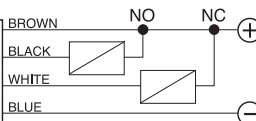
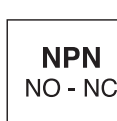

S50-P**A-2*-A00-NN	S50-P**A-2*-B01-NN	S50-P**A-2*-T01-NN	S50-P**A-2*-W03-NN	S50-P**A-2*-F01-NN
S50-P**A-2*-A00-PP	S50-P**A-2*-B01-PP	S50-P**A-2*-T01-PP	S50-P**A-2*-W03-PP	S50-P**A-2*-F01-PP
-	-	-	-	S50-P**A-2*-G00-XG

Laser models available on request

## DC PHOTOELECTRIC SENSORS PLASTIC & METAL IP67

Type DC M18 Ø18 <b>S51 SERIES</b>	Diffuse Proximity		Retro-Reflective		Through Beam	
	Short Distance	Long Distance	Non-Polarized	Polarized	Receiver	Emitter
<ul style="list-style-type: none"> <li>Nominal Voltage 10-30VDC</li> <li>Output: NO, NPN or PNP</li> <li>Output Current: ≤100mA</li> <li>Housing Material: PBT (plastic v) Nickel Plated Brass (metal v)</li> <li>Temperature Range: -25 to 55°C</li> <li>Flat plastic or cylindrical metal housing</li> <li>Cable or M12 connection NPN or PNP output</li> <li>Standard 3 wire connection configuration</li> </ul>						
Sensing Distance	100mm	400mm	0.1-4m (R5 Reflector)	0.1-3m (R5 Reflector)	20m	
DC Supply Voltage	10-30VDC		10-30VDC		10-30VDC	
Emission	Infrared LED 880nm		Infrared LED 880nm	Red LED 650nm	Infrared LED 880nm	
Setting	Sensitivity trimmer		Sensitivity trimmer		-	
Output LED	-		-		Yellow Output LED	
Switching Frequency	500Hz		500Hz		120Hz	
Operation Mode	Dark/Light selectable^		Dark/Light selectable^		Dark/Light selectable^	

^With Light/Dark input not connected the Proximity models function in the light mode, the retroreflex and through beam models in the Dark mode. The Light mode can be selected connecting the Light/Dark input to +Vdc and the Dark mode connecting it to the 0Vdc

Metal Housing Version	Wiring Diagrams			M12 Connector
<b>OUTPUT:</b>	<ul style="list-style-type: none"> <li>NPN Cable: S51-P**A-2*-C10-NK S51-P**A-2*-C01-NK S51-P**A-2*-A00-NK S51-P**A-2*-B01-NK S51-P**A-2*-F00-NK S51-P**A-2*-G00-XG</li> <li>PNP Cable: S51-P**A-2*-C10-PK S51-P**A-2*-C01-PK S51-P**A-2*-A00-PK S51-P**A-2*-B01-PK S51-P**A-2*-F00-PK</li> </ul>			
	<p>*For plug type replace 2 with 5 e.g. S51-PA-5-B01-PK For sensor cable and accessories see pages 68-71</p> <p>**For metal type replace P with M e.g. S51-MA-5-B01-PK For Radical Optics, replace A with R. E.g. S51-PR-5-B01-PK</p>			

## DC MINIATURE PHOTOELECTRIC SENSORS DARK/LIGHT MODE IP67

Type DC <b>S3Z SERIES</b>	Diffuse Proximity	Polarized Retro-Reflective	Narrow Beam Proximity	Through Beam Set
<ul style="list-style-type: none"> <li>Nominal Voltage 10-30VDC</li> <li>Output: NPN or PNP</li> <li>Output Current: ≤100mA</li> <li>Housing Material: PC/PBT</li> <li>Temperature Range: -25 to 55°C</li> </ul>				
Sensing Distance	0-700mm	0.05-4m (R5 Reflector)*	150mm	15m
DC Supply Voltage	10-30VDC			
Emission	Infrared LED 870nm	Red LED 665nm	Red LED 665nm	Infrared LED 870nm
Setting	Sensitivity trimmer			
Output LED	Yellow/Green (stability)			
Switching Frequency	500Hz			
Operation Mode	Dark or light			

Bracket	Nose	Wiring Diagrams		
<b>ST-5039</b> S3Z Mounting Bracket	<b>ST-S3Z-M18</b> M18 Threaded Adapter Nose for S3Z			
<b>OUTPUT:</b>	<ul style="list-style-type: none"> <li>PNP Light. Cable Version: S3Z-PR-2*-C11-PL S3Z-PR-2*-B01-PL S3Z-PR-2*-C01-PL S3Z-PR-2*-FG01-PL</li> <li>PNP Dark. Cable Version: S3Z-PR-2*-C11-PD S3Z-PR-2*-B01-PD S3Z-PR-2*-C01-PD S3Z-PR-2*-FG01-PD</li> <li>NPN Light. Cable Version: S3Z-PR-2*-C11-NL S3Z-PR-2*-B01-NL S3Z-PR-2*-C01-NL S3Z-PR-2*-FG01-NL</li> <li>NPN Dark. Cable Version: S3Z-PR-2*-C11-ND S3Z-PR-2*-B01-ND S3Z-PR-2*-C01-ND S3Z-PR-2*-FG01-ND</li> </ul>			







Light = NO. Dark = N.C. \*For plug type replace 2 with 5 e.g. S3Z-PR-5-C01-PL For sensor cable and accessories see pages 68-71  
 \*\*For plug and cable use part number CS-B1-02-G-05/03 (03 = 3m Cable, 05 = 5m Cable) Laser models available on request

LIMIT &amp; PRESSURE SWITCHES &amp; SENSORS





# ECONOMY DC MINIATURE SENSOR PNP/NPN IP67

Type DC <b>S100 SERIES</b>  <ul style="list-style-type: none"> <li>Nominal Voltage: 10-30VDC</li> <li>Output: NPN or PNP</li> <li>Output Current: 100mA</li> <li>Temperature Range: -25 to 55°C</li> <li>Housing Material: ABS (housing) / PMMA (indicators cover)</li> <li>Cost Effective</li> </ul>	<b>Medium Distance</b>   	<b>Long Distance</b>   	<b>Fixed Focus</b>   
	Sensing Distance	300mm	500mm
DC Supply Voltage	10-30VDC	10-30VDC	10-30VDC
Emission	Red LED 632nm	Red LED 632nm	Red LED 632nm
Switching Frequency	500 Hz	500 Hz	500 Hz
Operation Mode	Dark/Light input	Dark/Light input	Dark/Light input

**Plug Type**

Anti tampering sensor



Two threaded front mounting holes





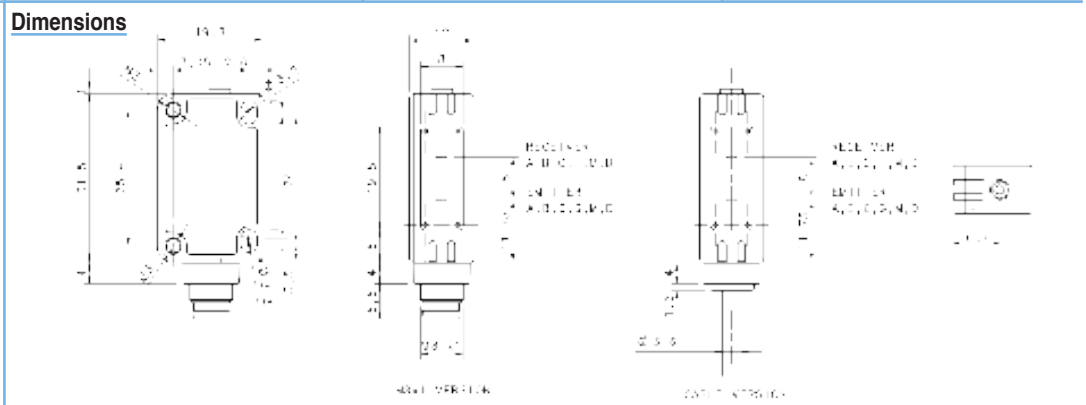



Two slotted rear mounting holes

**OUTPUT:**



PNP Cable	<b>S100-PR-2*-C00-PK</b>	<b>S100-PR-2*-C10-PK</b>	<b>S100-PR-2*-D00-PK</b>
NPN Cable	<b>S100-PR-2*-C00-NK</b>	<b>S100-PR-2*-C10-NK</b>	<b>S100-PR-2*-D00-NK</b>

\*For plug type replace 2 with 5 e.g. **S100-PR-5-C00-PK** For sensor cable and accessories see pages 68-71  
 \*For plug and cable, use code **CS-B1-02-G-03/05** (03 = 3m Cable, 05 = 5m Cable)

Type DC <b>S100 SERIES</b>  <ul style="list-style-type: none"> <li>Nominal Voltage: 10-30VDC</li> <li>Output: NPN or PNP</li> <li>Output Current: 100mA</li> <li>Temperature Range: -25 to 55°C</li> <li>Housing Material: ABS (housing) / PMMA (indicators cover)</li> <li>Cost Effective</li> </ul>	<b>Retro-Reflective</b> Non-Polarized		Polarized	<b>Background Suppression</b>	<b>Through Beam</b>
	 	 	 	 	
Sensing Distance	8m	6m	30-100mm	12m	
DC Supply Voltage	10-30VDC	10-30VDC	10-30VDC	10-30VDC	
Emission	Infrared LED 860nm	Red LED 632nm	Red LED 632nm	Infrared LED 860nm	
Switching Frequency	500 Hz	500 Hz	500 Hz	250Hz	
Operation Mode	Dark/Light input	Dark/Light input	External Teach-In	Dark/Light input	

**Bracket**



**ST-5039**

S100 Mounting Bracket

**OUTPUT:**

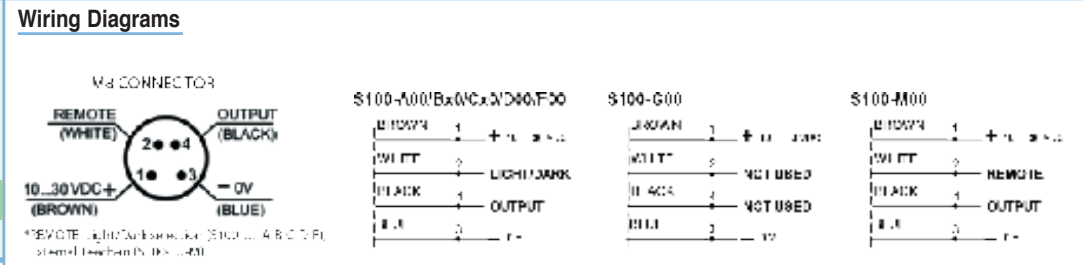











PNP Cable	<b>S100-PR-2*-A00-PK</b>	<b>S100-PR-2*-B10-PK</b>	<b>S100-PR-2*-M00-PH</b>	<b>S100-PR-2*-FG00-PK</b>
NPN Cable	<b>S100-PR-2*-A00-NK</b>	<b>S100-PR-2*-B10-NK</b>	<b>S100-PR-2*-M00-NH</b>	<b>S100-PR-2*-FG00-NK</b>





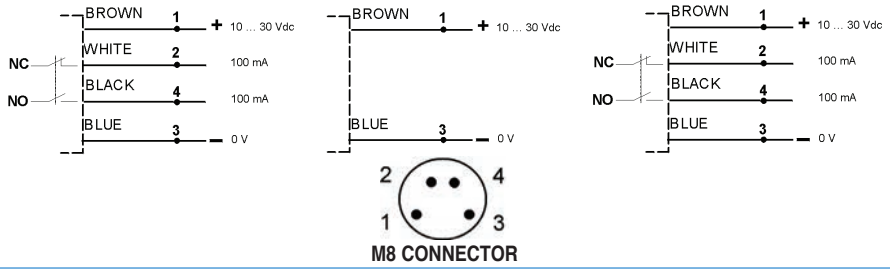



\*For plug type replace 2 with 5 e.g. **S100-PR-5-C00-PK** For sensor cable and accessories see pages 68-71  
 \*For plug and cable, use code **CS-B1-02-G-03/05** (03 = 3m Cable, 05 = 5m Cable)

LIMIT & PRESSURE SWITCHES & SENSORS

## MINIATURE PHOTOELECTRIC SENSOR BASIC LINE IP66

Type DC <b>S41 SERIES</b>	Diffuse Proximity	Retro-Reflective		Through Beam Emitter	Through Beam Receiver
		Polarized	Transparents		
<ul style="list-style-type: none"> <li>Nominal Voltage 10-30VDC</li> <li>Output: NPN or PNP NO-NC</li> <li>Output Current: 100mA max.</li> <li>Housing Material: PMMA Plastic</li> <li>Temperature Range: -25 to 55°C</li> <li>Models with trimmer setting</li> <li>NPN or PNP output</li> <li>Double NO-NC</li> </ul> 					
Sensing Distance	0.2-350mm	0.1-2.5m (R2 Reflector)	0.1-0.7m (R2 Reflector)	0.1-6m	0.1-6m
Supply Voltage	10-30VDC	10-30VDC	10-30VDC	10-30VDC	10-30VDC
Emission	Infrared LED 880nm	Red LED 660nm	Red LED 660nm	Infrared LED 880nm	Infrared LED 880nm
Setting	Sensitivity trimmer	Sensitivity trimmer	Sensitivity trimmer	-	-
Output LED	Red/Green	Yellow/Green	Red/Green	Red/Green	Red/Green
Switching Frequency	500Hz	500Hz	500Hz	500Hz	500Hz
Operation Mode	Dark or Light	Dark or Light	Dark or Light	Dark or Light	Dark or Light
<b>Bracket</b>	<b>Wiring Diagrams</b>  <b>ST-505</b> S40 and S41 Mounting Bracket <b>Plug Type</b> 				
<b>OUTPUT:</b>	 <b>M8 CONNECTOR</b>				
PNP NO-NC Cable	S41-2*-C-P	S41-2*-B-P	S41-2*-T-P	S41-2*-G	S41-2*-F-P
NPN NO-NC Cable	S41-2*-C-N	S41-2*-B-N	S41-2*-T-N	S41-2*-G	S41-2*-F-N
					
<p>*For plug type replace 2 with 5 e.g. S41-5-C-P For sensor cable and accessories see pages 68-71</p> <p>*For plug and cable use part number CS-B1-02-G-05/03 (03 = 3m Cable, 05 = 5m Cable)</p>					

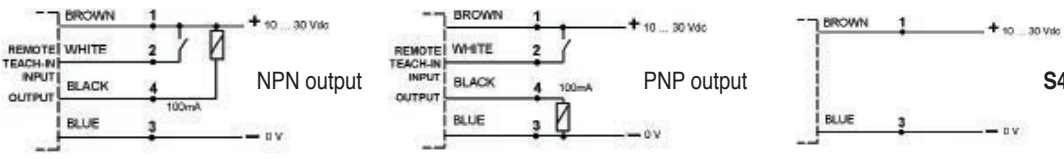
## PHOTOELECTRIC SENSORS MICROPROCESSOR-BASED TEACH-IN IP67

Type DC <b>S40 SERIES</b>	Diffuse Proximity	Retro-Reflective		Background Suppression
		Polarized	Transparents	
<ul style="list-style-type: none"> <li>Nominal Voltage 10-30VDC</li> <li>Output: NPN or PNP</li> <li>Output Current: 100mA max.</li> <li>Housing Material: ABS</li> <li>Temperature Range: -20 to 60°C</li> <li>EASyTouch™ microprocessor teach in and Remote setting</li> <li>Cable or M8 connection</li> <li>NPN or PNP</li> </ul> 				
Sensing Distance	0.5-300mm	0.1-2.5m (R2 Reflector)	0.1-7m (R2 Reflector)	15-100mm
DC Supply Voltage	10-30VDC	10-30VDC	10-30VDC	10-30VDC
Emission	Red LED 660nm	Red LED 660nm	Red LED 660nm	Red LED 660nm
Setting	Teach-in button	Teach-in push-button	Teach-in push-button	Teach-in button
Output LED	Yellow/Green	Yellow/Green	Yellow/Green	Yellow/Green
Switching Frequency	4kHz	1kHz	1kHz	1kHz
Operation Mode	Dark/light prog.	Dark/light programmable	Dark/light programmable	Dark/light prog.
<b>M8 Connector</b>	<b>Plug Type</b>  			
<b>OUTPUT:</b>	<b>Wiring Diagrams</b> 			
PNP Cable	S40-PR-2*-C03-PH	S40-PR-2*-B03-PH	S40-PR-2*-T03-PH	S40-PR-2*-M03-PH
NPN Cable	S40-PR-2*-C03-NH	S40-PR-2*-B03-NH	S40-PR-2*-T03-NH	S40-PR-2*-M03-NH
				
<p>*For plug type replace 2 with 5 e.g. S40-PR-5-A03-PH For sensor cable and accessories see pages 68-71</p> <p>*For plug and cable use part number CS-B1-02-G-05/03 (03 = 3m Cable, 05 = 5m Cable) Laser models available on request</p>				

# HIGH PERFORMANCE EUROPEAN STYLE MINATURE SENSOR ALL-IN ONE

Type DC S45 SERIES	Diffuse Proximity	Retro-Reflective		
		Polarized	Polarized autocollimated	Transparents autocollimated
<ul style="list-style-type: none"> <li>Nominal Voltage 10-30VDC</li> <li>Output NPN or PNP or PUSH PULL</li> <li>Output Current 100mA Max</li> <li>Current Consumption 30mA Max</li> <li>Housing Material ABS</li> <li>Cable Length 2m</li> <li>Dimensions (34x20x12mm)</li> </ul>				
Sensing Distance	800mm	2m	7m	2m
DC Supply Voltage	10-30VDC	10-30VDC	10-30VDC	10-30VDC
Emission	Red LED 632nm	Red LED 632nm	Red LED 632nm	Red LED 632nm
Setting	Teach-in button	Teach-in button	Teach-in button	Teach-in button
Switching Frequency	1000Hz	1000Hz	1000Hz	1000Hz
Output LED	Yellow Output - Green Power	Yellow Output - Green Power	Yellow Output - Green Power	Yellow Output - Green Power
Operation Mode	Light / Dark	Light / Dark	Light / Dark	Light / Dark

### Wiring Diagrams

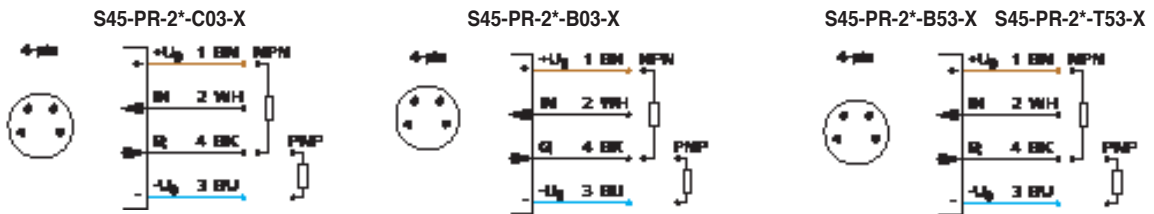

### OUTPUT:

PNP Cable Version	S45-PR-2*-C03-PH	S45-PR-2*-B03-PH	S45-PR-2*-B53-PH	S45-PR-2*-T53-PH
NPN Cable Version	S45-PR-2*-C03-NH	S45-PR-2*-B03-NH	S45-PR-2*-B53-NH	S45-PR-2*-T53-NH

\*For plug type replace 2 with 5 e.g. S45-PR-5-C03-PH For sensor cable and accessories see pages 68-71

\*For plug and cable use part number. CS-B1-02-G-05/03 Laser models available on request

Type DC M18 Ø18 SERIES S45	Background Suppression	Contrast		Distance	Through Beam
		White Emission	RGB Emission		
<ul style="list-style-type: none"> <li>Nominal Voltage 10-30VDC</li> <li>Output NPN or PNP or PUSH PULL</li> <li>Output Current 100mA Max</li> <li>Current Consumption 30mA Max</li> <li>Housing Material ABS</li> <li>Cable Length 2m</li> <li>Dimensions (34x20x12mm)</li> </ul>					
Sensing Distance	400mm	12mm	12mm	200mm	20m
DC Supply Voltage	10-30VDC	10-30VDC	10-30VDC	10-30VDC	10-30VDC
Emission	Red LED 632nm	White LED	RGB LED	Red LED 632nm	Red LED 632nm
Setting	Teach-in button	Teach-in button	Teach-in button	Teach-in button	Teach-in button
Switching Frequency	1000Hz	25 kHz	25 kHz	1000Hz	1000Hz
Output LED	Yellow Output - Green Power	Yellow Output - Green Power	Yellow Output - Green Power	Yellow Output - Green Power	Yellow Output - Green Power
Operation Mode	Light / Dark	Light / Dark	Light / Dark	Light / Dark	Light / Dark

### Wiring Diagrams

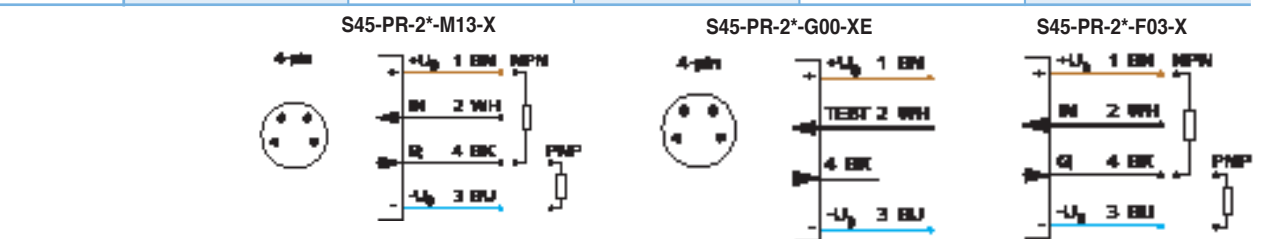

### OUTPUT:













PNP Cable Version	S45-PR-2*-M13-PH	S45-PR-2*-W13-OH	S45-PR-5-W43-OH	S45-PR-5-Y13-PV	S45-PR-2*-F03-PH
NPN Cable Version	S45-PR-2*-M13-NH	-	-	S45-PR-5-Y13-NV	S45-PR-2*-F03-NH
Emitter	-	-	-	-	S45-PR-2*-G00-XE





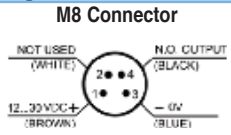
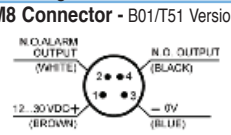
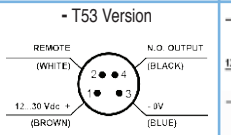

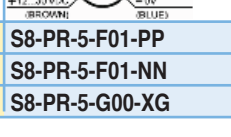







\*For plug type replace 2 with 5 e.g. S45-PR-5-C03-PH For sensor cable and accessories see pages 68-71

\*For plug and cable use part number. CS-B1-02-G-05/03 Laser models available on request



## DC ADVANCED PHOTOELECTRIC SENSORS IP67 ATEX

Type DC <b>S8 SERIES</b>	Diffuse Proximity	Retro-Reflective		Through Beam
		Polarized	Transparents	
<ul style="list-style-type: none"> <li>Nominal Voltage 12-30VDC</li> <li>Output: NPN or PNP NO</li> <li>Output Current: ≤100mA max.</li> <li>Housing Material: ABS</li> <li>Temperature Range: -10 to 55°C</li> <li>Excellent performances within small dimensions (14x42x25mm)</li> <li>Compact Dimensions</li> <li>Very High Resolution</li> <li>High performance for most challenging applications</li> </ul>				
				
Sensing Distance	500mm	5m (R2 Reflector)	50-800mm**	25m
DC Supply Voltage	12-30VDC	12-30VDC		12-30VDC
Emission	Red LED 660nm	Red LED 660nm		Red LED 660nm
Setting	Mono turn sensitivity adj. trimmer	Mono turn sensitivity adj. trimmer	Set push button (T53)	Mono turn sensitivity adj. trimmer
Output LED	Yellow/Green	Yellow/Green		Yellow/Green
Response Time	500us	500us	250us	500us
Switching Frequency	1kHz	1kHz	2kHz	1kHz
Operation Mode	Dark/Light selectable	Dark/Light selectable		Dark/Light selectable
Wiring Diagrams	<p><b>M8 Connector</b></p> 	<p><b>M8 Connector - B01/T51 Version</b></p> 	<p><b>- T53 Version</b></p> 	<p><b>M8 Connector - F01 Version</b></p>  <p><b>- G00 Version</b></p> 
<b>OUTPUT:</b>				
PNP M8 Plug*	<b>S8-PR-5-C01-PP</b>	<b>S8-PR-5-B01-PP</b>	<b>S8-PR-5-T51**-PP</b>	<b>S8-PR-5-F01-PP</b>
NPN M8 Plug*	<b>S8-PR-5-C01-NN</b>	<b>S8-PR-5-B01-NN</b>	<b>S8-PR-5-T51**-NN</b>	<b>S8-PR-5-F01-NN</b>
Through Beam Emitter	-	-	-	<b>S8-PR-5-G00-XG</b>
 <p>Stainless Steel models available on request</p> <p>**For retro-reflective for transparent units with 2000mm sensing distance replace 1 with 3 e.g. <b>S8-PR-5-T53-PP</b></p> <p>For plug and cable use part number <b>CS-B1-02-G-05/03</b> (03 = 3m Cable. 05 = 5m Cable)</p>				

Type DC <b>S8 SERIES</b>	Clear and Shiny Detection		Background Suppression		Contrast	
<ul style="list-style-type: none"> <li>Nominal Voltage 12-30VDC</li> <li>Excellent performances within small dimensions</li> <li>Compact Dimensions</li> <li>Very High Resolution</li> </ul>						
						
Sensing Distance	100-300mm	50-150mm	50-300mm	20-200mm	9mm	
DC Supply Voltage	12-30VDC		12-30VDC		12-30VDC	
Emission	Red LED 660nm	Red Laser	Red LED 660nm	Red Laser	Blue, Green, Red	
Setting	8-turn distance adj. trimmer, Teach		8-turn distance adj. trimmer		Teach-in push-button	
Output LED	Yellow/Green		Yellow/Green		Yellow/Green	
Response Time	1ms		1ms	100us	50us	20us
Switching Frequency	500Hz		500Hz	5kHz	10kHz	25kHz
Operation Mode	Remote Dark/Light selectable		Dark/Light selectable		Dark/Light selectable	
Bracket	 <p><b>ST-5072</b> S8 Mounting Bracket</p>					
<b>OUTPUT:</b>						
PNP M8 Plug*	<b>S8-PR-5-M53-PP</b>	<b>S8-PH-5-M53-PP</b>	<b>S8-PR-5-M01-PP</b>	<b>S8-PH-5-M01-PP</b>	<b>S8-PR-5-W03-PP</b>	<b>S8-PR-5-W13-PP</b>
NPN M8 Plug*	-	-	<b>S8-PR-5-M01-NN</b>	<b>S8-PH-5-M01-NN</b>	<b>S8-PR-5-W03-NN</b>	-
 <p>For plug and cable use part number <b>CS-B1-02-G-05/03</b> (03 = 3m Cable. 05 = 5m Cable)</p>						

**LASER RADIATION**  
DO NOT STARE INTO BEAM  
CLASS 2 LASER PRODUCT  
IEC 60825-1 (2007)

P = 5 mW  
t<sub>avg</sub> = 3 us  
λ = 660 nm

All the safety electrical and mechanical regulations and laws have to be respected during sensor functioning. The sensor has to be protected against mechanical damages. Place the given labels in a visible position close to the laser emission.

- Do not look directly into the laser beam!
- Do not point the laser beam towards people!
- These sensors are not to be used for safety applications!

# UNIVERSAL SENSOR - 50X50MM HOUSING IP67

Type DC <b>S62 SERIES</b>	Diffuse Proximity		Retro-Reflective		Through Beam		
	C01	C11	Non-Polarised	Polarised	Receiver	Emitter	
<ul style="list-style-type: none"> <li>The most complete universal sensor in a compact 50x50mm housing</li> <li>New better modern look 50x50 housing</li> <li>Better performance</li> <li>Retroreflective up to 13m</li> <li>VDC and VAC Models</li> </ul>							
	Sensing Distance	0-900mm	0-200cm	0.1-13m (R2,R5 reflector)	0.1-8m (R2,R5 reflector)	0-25m	0-25m
	Supply Voltage	10-30VDC / 24-240VAC/24-60VDC**					
	Emission	RED 640nm					Red 640nm
	Setting	Mono-turn sensitivity adjustment trimmer. Mono-turn light/dark trimmer ( <b>S62-RX/PN</b> )					
	Output LED	OUTPUT LED (yellow) / STABILITY LED (green)					POWER ON LED (green)
	Output	NPN/PNP ( <b>S62-PN</b> )DC vers. NPN or PNP NO/NC ( <b>S62-PP/NN</b> ) DC vers. Relay SPDT 250VAC/30VDC ( <b>S62-RX</b> )					Test + Test -
	Output Current	<b>S62-PA-2/5, S62-M</b> version: ≤100mA (overload and overvoltage protection), <b>S62-PA-1-RX</b> version: 2A Max (resist load)					
	Saturation Voltage	≤2v <b>S62-PA-2/5</b> VDC vers					
	Response Time	500us max, 25ms (Relay version)		500us max, 25ms (Relay version)		1ms, 25ms (Relay version)	
	Switching Frequency	1kHz, 20Hz (Relay version)		2kHz, 20Hz (Relay version)		50kHz, 20Hz	
	Mechanical Protection	IP67		IP67		IP67	
	Housing Material	ABS		ABS		ABS	
	Operating Temperature	-10 to 55°C		-10 to 55°C		-10 to 55°C	

**Brackets**

**JOINT-62**  
Adjustable S62 Mounting Bracket

**ST-504**  
S62 Mounting Bracket

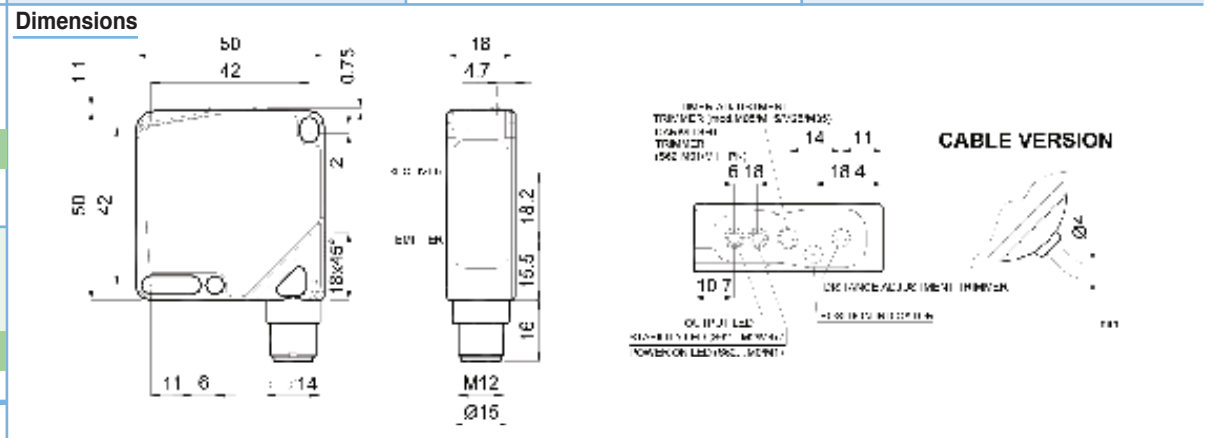

**OUTPUT:**

NPN NO-NC Cable	<b>S62-PA-2*-C01-NN</b>	<b>S62-PA-2*-C11-NN</b>	-	<b>S62-PA-5-B01-NN</b>	<b>S62-PA-2*-F01-NN</b>	
PNP NO-NC Cable	<b>S62-PA-2*-C01-PP</b>	<b>S62-PA-2*-C11-PP</b>	-	<b>S62-PA-2*-B01-PP</b>	<b>S62-PA-2*-F01-PP</b>	<b>S62-PA-2*-G00-XG</b>
NPN/PNP Cable	<b>S62-PA-2*-C01-PN</b>	<b>S62-PA-2*-C11-PN</b>	<b>S62-PA-2*-A01-PN</b>	<b>S62-PA-2*-B01-PN</b>	<b>S62-PA-2*-F01-PN</b>	
Relay Cable**(AC)	<b>S62-PA-1-C01-RX</b>	<b>S62-PA-1-C11-RX</b>	<b>S62-PA-1-A01-RX</b>	<b>S62-PA-1-B01-RX</b>	<b>S62-PA-1-F01-RX</b>	<b>S62-PA-1-G00-XX</b>

\*For plug type replace 2 with 5 e.g. **S62-PA-5-C01-NN** Laser models available on request

For sensor cable and accessories see pages 68-71

## Wiring Diagrams

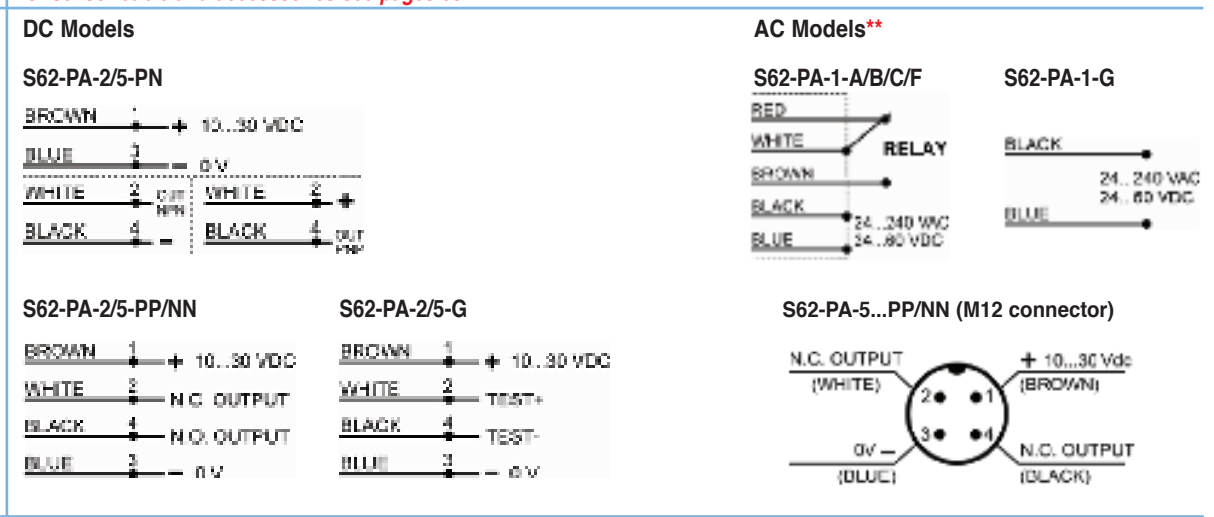

LIMIT & PRESSURE SWITCHES & SENSORS

# BACKGROUND SUPPRESSION - 50X50MM HOUSING IP67

Type DC <b>S62 SERIES</b>	<b>Background Suppression</b>			
<ul style="list-style-type: none"> <li>Nominal Voltage 10-30VDC</li> <li>Units with time adjustment trimmer</li> <li>Background suppression from 3cm-2m</li> </ul>				
Sensing Distance	30-300mm	60-600mm	60-1200mm	200-2000mm
DC Supply Voltage	10-30VDC	10-30VDC	10-30VDC	10-30VDC
Emission	RED 660nm		Infrared (880nm)	
Setting	Multi Turn distance adjustment trimmer / Timer adjustment trimmer (S62-M05/M15/M25/M35). Dark/light selection mono turn trimmer (S62-M01/M11-PN)			
Output LED	OUTPUT LED (yellow) / STABILITY LED (green) (S62-M0/M1) POWER ON LED (green) (S62-M2/M3)			
Output	NPN or PNP NO/NC (S62-PP/NN)			
Output Current	100mA (overload and voltage protection)			
Saturation Voltage	≤2v	≤2v	≤2v	≤2v
Response Time	500us (S62-M0/M1), 1ms (S62-M2) 1,5ms(S62-M3)			
Switching Frequency	1kHz (S62-M0/M1), 500Hz (S62-M2), 330Hz (S62-M3)			
Mechanical Protection	IP67	IP67	IP67	IP67
Housing Material	ABS	ABS	ABS	ABS
Operating Temperature	-10 to 55°C	-10 to 55°C	-10 to 55°C	-10 to 55°C

**Brackets**



**JOINT-62**

Adjustable S62 Mounting Bracket



**ST-504**

S62 Mounting Bracket

**Dimensions**

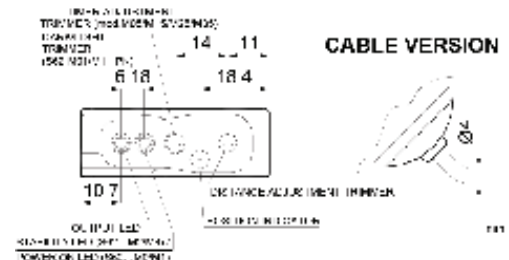
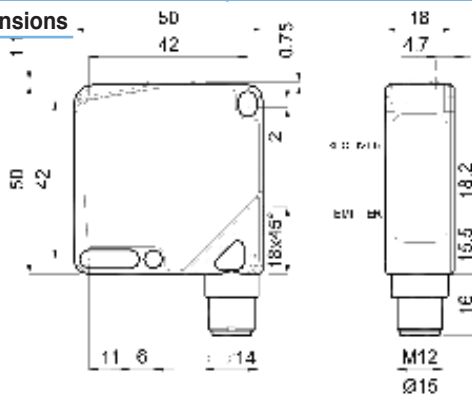

**OUTPUT:**

PNP NO-NC Cable	S62-PA-2-M01-PP	S62-PA-2-M11-PP	S62-PA-2-M21-PP	S62-PA-2-M31-PP
NPN NO-NC M12 Plug	S62-PA-5-M01*-NN	S62-PA-5-M11*-NN	S62-PA-5-M21*-NN	S62-PA-5-M31*-NN
PNP NO-NC M12 Plug	S62-PA-5-M01*-PP	S62-PA-5-M11*-PP	S62-PA-5-M21*-PP	S62-PA-5-M31*-PP

\* For units with timer adjustment trimmer change 1 to 5 e.g. S62-PA-5-M01-NN to S62-PA-5-M05-NN

For sensor cable and accessories see pages 68-71

Laser models available on request

**Wiring Diagrams**

**S62-PA-2/5...PN**

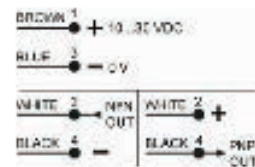

**S62-PA-2...PP/PN**

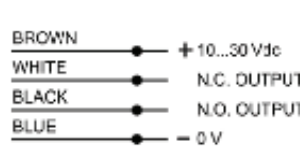

**S62-PA-5...PP/PN (M12 connector)**

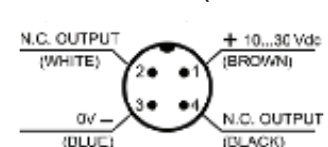

**Detection Diagrams**

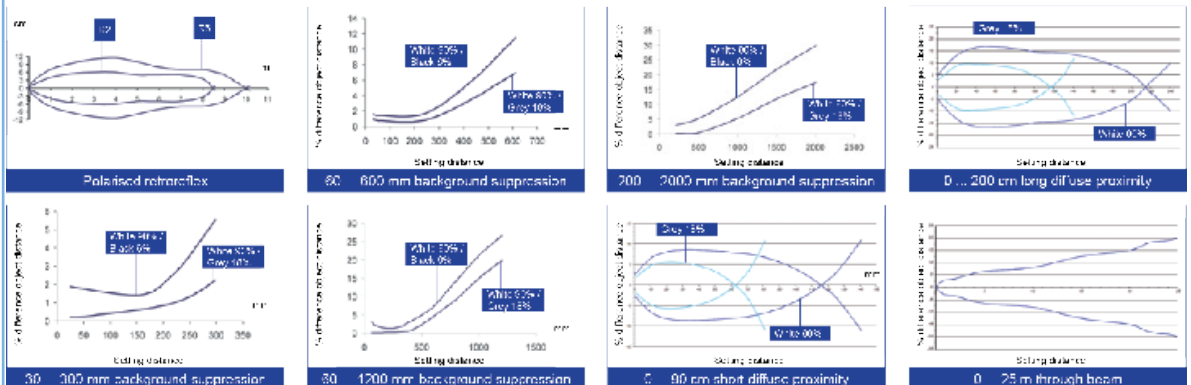



# MAXI SENSOR FOR CRITICAL APPLICATIONS VAC/VDC IP67

Type AC/DC	Diffuse Proximity	Polarized Retro-Reflective	Background Suppression	Through Beam	
S300-PR SERIES				Receiver	Emitter
<ul style="list-style-type: none"> <li>Excellent Optical Performances</li> <li>Heavy duty industrial plastic housing</li> <li>Distance trimmer clutch for mechanical background suppression models</li> <li>Units with defogging functions</li> </ul>					
Sensing Distance	5m	22m	2.5m	60m	
Supply Voltage	24-240VAC / 12-240VDC				
Emission	Infrared LED 940nm	Infrared LED 880nm	Infrared LED 880nm	Infrared LED 880nm	
Setting	Mono-turn Sensitivity Trimmer	Mono-turn Sensitivity Trimmer	Multi-turn Adjustment Screw	Mono-turn Sensitivity Trimmer	
Output LED	Output LED (Yellow) Stability LED (GREEN)			Output Yellow/ Stability Green	Power On LED Green
Output	NPN & PNP open collector. Relay SPDT electromagnetic relay 250VAC, 30VDC*				
Output current	100mA (Resistive Load). 3A (Resistive Load)*				
Saturation Voltage	<2.4V Max NPN & PNP only				
Response Time	20ms (AC), 1ms (S300-C, S300-B, S300-F/G) (DC) 2ms (S300-M) (DC)				
Switching Frequency	25Hz (AC), 500Hz (S300-B, S300-C, S300-F/G) (DC), 250Hz (S300-M) (DC)				
Mechanical Protection	IP67				
Housing Material	PBT (30% Fibre-reinforced Glass)				
Connections	Terminal Block (Recommended Cable Diameter 8mm – 10mm) (AC), 4-Pin M12 Plug (DC)				
Operating Temperature	-40° to 55°C				

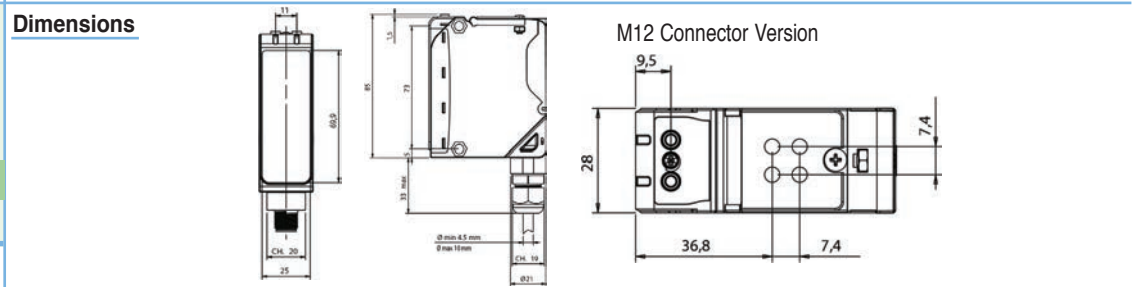

**OUTPUT:**

Relay NO/NC ADJ, No Timer	S300-PR-1-C01-RX	S300-PR-1-B01-RX	S300-PR-1-M01-RX	S300-PR-1-F01-RX	S300-PR-1-G00-EX***†
Relay NO/NC ADJ, Timer	S300-PR-1-C06-RX***	S300-PR-1-B06-RX***	S300-PR-1-M06-RX***	S300-PR-1-F06-RX***	
NPN & PNP M12 Plug ADJ, No Timer	S300-PR-5-C01-OC	S300-PR-5-B01-OC	S300-PR-5-M01-OC	S300-PR-5-F01-OC	S300-PR-5-G00-EX***†
NPN & PNP M12 Plug ADJ, Timer	S300-PR-5-C06-OC	S300-PR-5-B06-OC	S300-PR-5-M06-OC	S300-PR-5-F06-OC	

\*24-240VAC/12-240VDC AC voltage units only. \*\*\*For defogging functions, add -M to part number. †No ADJ, No Timer, No Outputs

For sensor cable and accessories see pages 68-71

## Wiring Diagrams

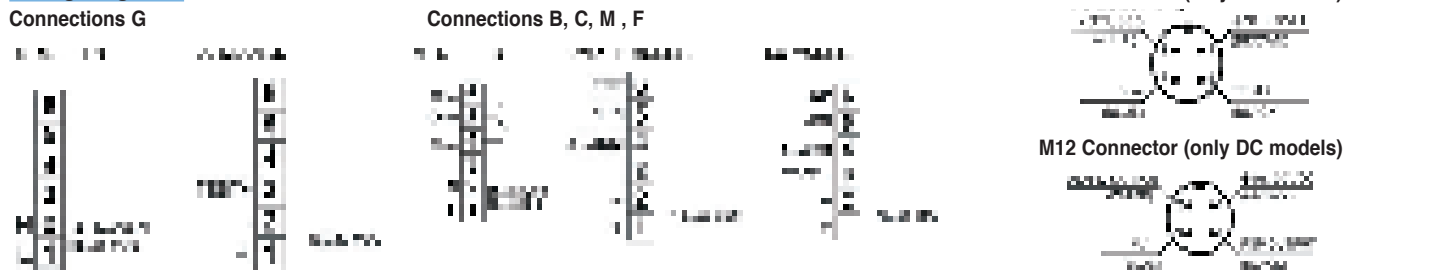

## Timing Functions

Four selectable timing functions: one shot, ON delay, OFF delay, ON/OFF delay and normal mode. Trimmer adjustment of the functions is available. The timing functions can be particularly useful in applications where the output signal pulse has to be modified.

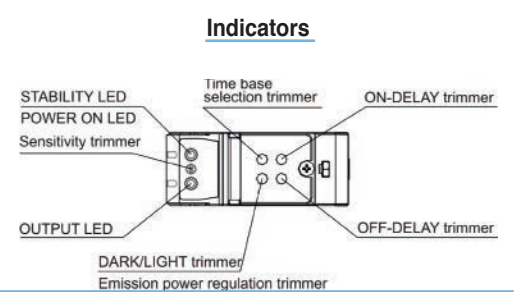



# COMPLETE RANGE OF CONTRAST, REGISTRATION MARK, >>

Type DC	TLU Series		TL46 Series	
			Trimmer	Basic
<ul style="list-style-type: none"> <li>Nominal Voltage 10-30VDC</li> <li>World leading mark sensors</li> <li>Red/green or white LED emission</li> <li>Rotatable connector</li> </ul>				
Sensing Distance	6-12mm		6-12mm	6-12mm
DC Supply Voltage	10-30VDC		10-30VDC	10-30VDC
Setting	Teach-in with 2 Pushbuttons / Remote		<b>Multi Turn Digital Trimmer</b> for an easy and quick adjustment of the switching threshold	Automatic
Output LED	Red Output / Green Ready		Yellow Output / Green Ready / Orange Indicator Arrows	Yellow Output / Green Ready
Emission	Red / Green LED		White 400-700nm	RGB LED
Spot	<b>Vertical</b>	<b>Horizontal</b>	<b>Vertical</b>	<b>Vertical</b> <b>Horizontal</b>
Spot Dimension	1.5 x 5mm		1.5 X 5mm	1.5 X 5mm
Output	NPN and PNP		NPN and PNP Programmable	NPN or PNP Programmable
Analogue Output	Yes 0-5VDC		0.5-5.5VDC on white target	0.5-5.5VDC on white target
Output Current	200mA Max		<100mA Max	<100mA Max
Saturation Voltage	1V max (NPN Version) 2V Max (PNP Version)		< 2V	< 2V
Response Time	50us		25us	33us
Switching Frequency	10KHz		20KHz	15KHz
Operation Mode	Automatic Dark/Light Selection		Dark/Light with switch	Dark/Light selectable
Mechanical Protection	IP67		IP67	IP67
Housing Material	ZAMA		Aluminium	Aluminium
Operating Temperature	-10° to 55°C		-10° to 55°C	-10° to 55°C
Connections	3m 6.1mm Shielded Cable *M12 4-Pole connector		*M12 5-Pole Connector	*M12 5-Pole Connector

### Dimensions

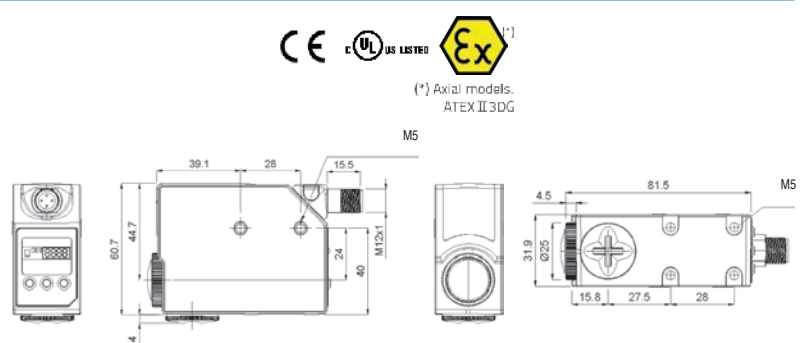
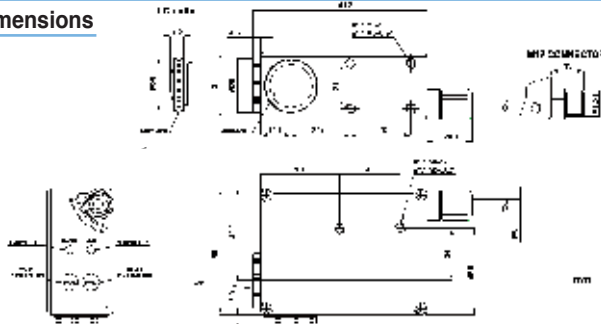

### OUTPUT:

Output Type	TLU-011**	TLU-011**L	TL46-A-425	TL46-W-815	TL46-W-815L
NPN & PNP (Programmable)	-	-	-	-	-
NPN Cable	TLU-011**	TLU-011**L	TL46-A-425	-	-
PNP Cable	TLU-111**	TLU-111**L	TL46-A-415	-	-
NPN-NO RS485	-	-	-	-	-
PNP-NO RS485	-	-	-	-	-

\*\*For plug type replace 1 with 5 e.g. TLU-115

For sensor cable and accessories see pages 68-71

### Wiring Diagrams

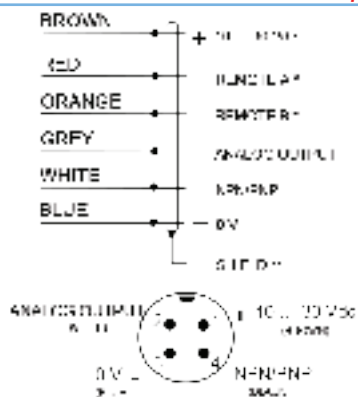

### Trimmer Verion

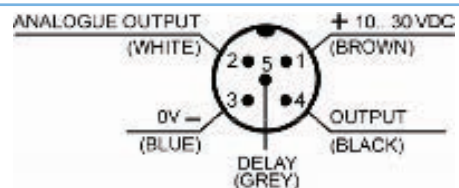





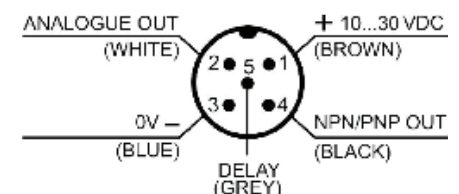

### Basic Standard and Enhanced Versions

\*\* For plug and cable use part number CS-A1-03-G-03





» **COLOUR AND LUMINESCENCE SENSORS IP67**

TL46 Series		Color Mark Sensor		Colour S65-V Series
Standard	Enhanced			
				
6-12mm	6-12mm	15mm		5-45mm
10-30VDC	10-30VDC	12-24VDC		10-30VDC
Automatic / Manual / Remote	Automatic / Manual / Remote / Dynamic	3-level teach color, color + intensity		SET & SEL push buttons
Yellow Output / Green Ready / Orange Delay / Orange Keylock / 5 Segment Bargraph	Yellow Output / Green Ready / Orange Delay / Orange Keylock / 4 Digit Display	Red Operation, Green Stability, Orange Timer		4 Digit Display Green active Outputs, yellow or function output
RGB LED	RGB LED	RGB LED		White LED 400-700nm
<b>Vertical</b>	<b>Horizontal</b>	<b>Vertical</b>	<b>Horizontal</b>	
1.5 X 5mm	1.5 X 5mm	Rectangular		
NPN or PNP Programmable	NPN or PNP Programmable	1.24 x 6.7mm		4mm at 20mm
Yes 0-5VDC	Yes 0-5VDC	NPN and PNP		3 x PNP or NPN
<100mA Max	<100mA Max	<100mA Max		<100mA Max
< 2V	< 2V	1V NPN, 2V PNP		< 2V
25us	17us	500us		335us
20KHz	30KHz	1vKHz		1.5KHz
Dark/Light Selectable	Dark/Light Selectable	NO or NC		C or C+I Independent for each channel
IP67	IP67	IP67		IP67
Aluminium	Aluminium	Polycarbonate		ABS
-10° to 55°C	-10° to 55°C	-10° to 55°C		-10° to 55°C
*M12 5-Pole Connector	*M12 5-Pole Connector	M12 4-pin		*M12 - 8 Pole Connector

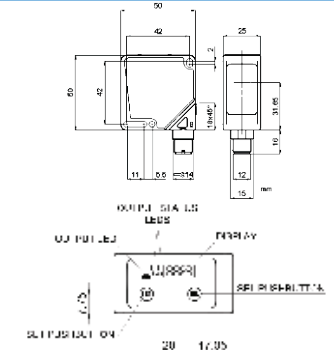
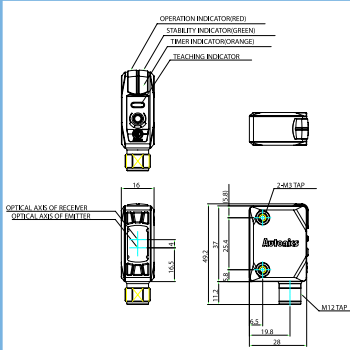
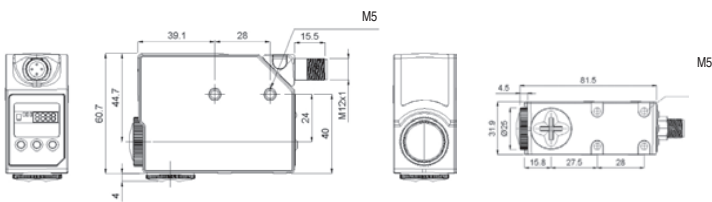

TL46-WL-815	TL46-WL-815L	TL46-WLF-815	TL46-WLF-815L	-	-
-	-	-	-	BC15-LDT-C	-
-	-	-	-	BC15-LDT-C-P	-
-	-	-	-	-	S65-PA-5-V09-NNNZ
-	-	-	-	-	S65-PA-5-V09-PPPZ

For sensor cable and accessories see pages 68-71

Version	pin 1	pin 2	pin 3	pin 4	pin 5 *
TL46-A Immer	(brown)	(white)	(blue)	(black)	(grey)
TL46-W Base	+10...30Vdc	0...5Vdc output	0Vdc	PNP or NPN output	Delay
TL46-WI Std	+10...30Vdc	1...5.5Vdc output	0Vdc	NPN/PNP output	Delay
TL46-WLF Enh.	+10...30Vdc	1...5.5Vdc output	0Vdc	NPN/PNP output	Remote
TL46-WLF Enh.	+10...30Vdc	Dark/Light Dyn.	0Vdc	NPN/PNP output	Remote/Dyn.

\* A M12 4-pole connector can be used if the PINS function is not necessary

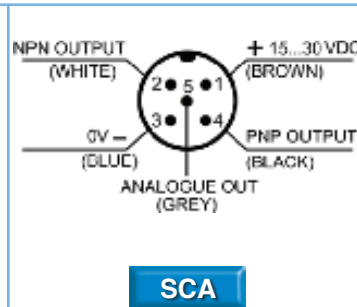

**SCA**

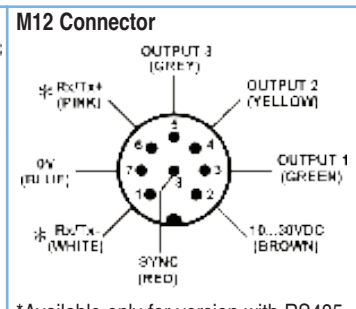

\* Available only for version with RS485 serial connection (S65-PA-5-V09-xxxZ)

\*\* For plug and cable use part number CS-A1-06-B-03

\*\* For plug and cable use part number CS-A1-03-G-03

## DC LASER PNP/NPN NO-NC IP67

Type DC M18 S50 SERIES	Laser Diffuse Proximity	Laser Retro-Reflective	Laser Receiver	Laser Emitter
<ul style="list-style-type: none"> <li>Output: NPN or PNP NO-NC</li> <li>Output Current: <math>\leq 100\text{mA max.}</math></li> <li>Response Time 333<math>\mu\text{s}</math></li> <li>Housing Material: PBT</li> <li>Temperature Range: -10 to 50°C</li> </ul>				
Sensing Distance	0-350mm	0-16m	0-60m	0-60m
Supply Voltage	10-30VDC	10-30VDC	10-30VDC	10-30VDC
Emission	Red Laser 650nm <sup>2</sup>	Red Laser 650nm <sup>2</sup>	Red Laser 650nm <sup>2</sup>	Red Laser 650nm <sup>2</sup>
Setting	Sensitivity trimmer	Sensitivity trimmer	Sensitivity trimmer	Sensitivity trimmer
Output LED	Green/Yellow	Green/Yellow	Green/Yellow	Green/Yellow
Switching Frequency	1.5kHz	1.5kHz	1.5kHz	1.5kHz
<b>Dimensions</b>				
<b>OUTPUT:</b>				
PNP NO-NC M12	S50-PL-5-C01-PP	S50-PL-5-B01-PP	S50-PL-5-F01-PP	-
NPN NO-NC M12	S50-PL-5-C01-NN	S50-PL-5-B01-NN	S50-PL-5-F01-NN	-
Emitter	-	-	-	S50-PL-5-G00-XG
<b>Wiring Diagrams</b>				









*For sensor cable and accessories see pages 68-71*





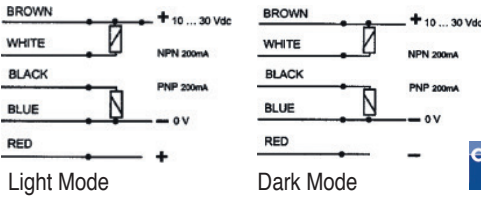
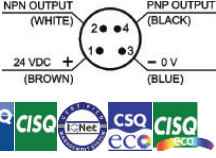
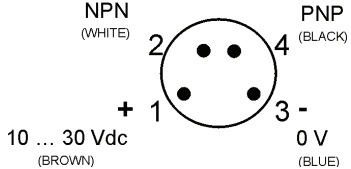

## DC LASER PNP/NPN NO-NC IP67

Type DC S60 SERIES	Laser diffuse proximity	Laser Retro-Reflective	Laser Receiver	Laser Emitter
<ul style="list-style-type: none"> <li>Output: NPN or PNP NO-NC</li> <li>Output Current: <math>\leq 100\text{mA max.}</math></li> <li>Response Time 250<math>\mu\text{s}</math></li> <li>Housing Material: ABS</li> <li>Temperature Range: -10 to 50°C</li> </ul>				
Sensing Distance	0-600mm	0.1-20m	0-60m	0-60m
Supply Voltage	10-30VDC	10-30VDC	10-30VDC	10-30VDC
Emission	Red Laser 650nm <sup>2</sup>	Red Laser 650nm <sup>2</sup>	Red Laser 650nm <sup>2</sup>	Red Laser 650nm <sup>2</sup>
Setting	Sensitivity trimmer	Sensitivity trimmer	Sensitivity trimmer	Sensitivity trimmer
Output LED	Green/Yellow	Green/Yellow	Green/Yellow	Green/Yellow
Switching Frequency	2kHz	2kHz	1.5kHz	1.5kHz
<b>Dimensions</b>				
<b>OUTPUT:</b>				
PNP NO-NC M12	S60-PL-5-C01-PP	S60-PL-5*-B01-PP	S60-PL-5-F01-PP	-
NPN NO-NC M12	S60-PL-5-C01-NN	S60-PL-5-B01-NN	S60-PL-5-F01-NN	-
Emitter	-	-	-	S60-PL-5-G00-XG
<b>Wiring Diagrams</b>				

*For sensor cable and accessories see pages 403-405*

\*For cable type replace 5 with 2

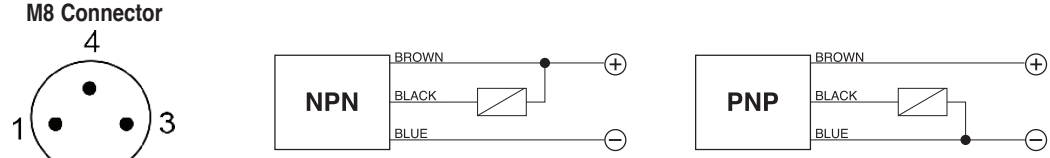
ECONOMY U-SHAPE SENSORS			2mm SLOT SENSORS IP65		
	SR31 Series 30mm	SR22 Series 1mm	Slot Width SR21 Series	2mm	2mm
<ul style="list-style-type: none"> <li>Output Current: 200mA max.</li> <li>Switching Frequency 10kHz</li> </ul>	Fork 	Slot 	<ul style="list-style-type: none"> <li>High 25kHz switching frequency</li> <li>Detection of semi-transparent labels</li> <li>Detection of register marks on transparents</li> <li>NPN and PNP output</li> <li>Output: NPN &amp; PNP</li> <li>Output Current: 100mA Sci Protection</li> <li>Housing Material: ZAMA</li> <li>Temperature Range: -20 to 60°C</li> </ul>		
<b>CE</b>					
DC Supply Voltage	10-30VDC	24VDC	DC Supply Voltage	10-30VDC	10-30VDC
Setting	Multi-turn Sensitivity Trimmer	Trimmer	Emission	Infrared LED 880nm	Green LED 535nm
Output LED	Red Output	Red Output	Setting	Auto Set push-button	Auto Set push-button
Output	NPN or PNP	NPN & PNP	Resolution	0.5mm	0.5mm
Operation Mode	Dark/Light Configurable	Dark and Light	Output LED	Yellow	Yellow
Housing Material	ZAMA	Aluminium	Operating Mode	Light/Dark	Light/Dark
<b>Wiring Diagrams</b>			<b>Wiring Diagrams</b>		
					
<b>OUTPUT:</b> NPN & PNP (programmable) <b>SR31</b> - Dark Mode      - <b>SR22-5-IR-OD</b> Light Mode      - <b>SR22-5-IR-OL</b>			<b>CE</b> <b>UL LISTED</b> 		
			<b>OUTPUT:</b> PNP & NPN M8 <b>SR21-IR</b> <b>SR21-RG</b>		
			For plug and cable use part number <b>CS-B1-02-G-05/03</b> (03 = 3m Cable, 05 = 5m Cable) For sensor cable and accessories see pages 68-71		

ULTIMATE PRECISION FORK TYPE PHOTOELECTRIC SENSOR					
Fork Width	30mm	50mm	80mm	120mm	
<b>SRF SERIES</b> <b>CE</b> <b>IP65</b> <ul style="list-style-type: none"> <li>Nominal Voltage 10-30VDC</li> <li>Output: NPN or PNP</li> <li>Output Current: 200mA Sci Protection</li> <li>Switching Frequency: 1.5kHz</li> <li>Housing Material: Anodised Aluminium</li> <li>Temperature Range: -10 to 60°C</li> <li>High resolution with visible red LED emission</li> <li>Sensitivity adjustment trimmer</li> <li>Sturdy industrial metal housing with glass lenses</li> </ul>					
DC Supply Voltage	10-30VDC	10-30VDC	10-30VDC	10-30VDC	
Emission	Red LED 640nm <sup>2</sup>	Red LED 640nm <sup>2</sup>	Red LED 640nm <sup>2</sup>	Red LED 640nm <sup>2</sup>	
Setting	Sensitivity trimmer	Sensitivity trimmer	Sensitivity trimmer	Sensitivity trimmer	
Resolution	0.3mm	0.5mm	0.5mm	0.8mm	
Output LED	Red LED	Red LED	Red LED	Red LED	
Response Time	333μs	333μs	333μs	333μs	
Operation Mode	Light/Dark	Light/Dark	Light/Dark	Light/Dark	
<b>Wiring Diagrams</b>					
					
<b>OUTPUT:</b>					
PNP NO-NC Selectable M8	<b>SRF-30-5-P</b>	<b>SRF-50-5-P</b>	<b>SRF-80-5-P</b>	<b>SRF-120-5-P</b>	
NPN NO-NC Selectable M8	<b>SRF-30-5-N</b>	<b>SRF-50-5-N</b>	<b>SRF-80-5-N</b>	<b>SRF-120-5-N</b>	
For plug and cable use part no. <b>CS-B1-01-G-05 (axial)</b> For sensor cable and accessories see pages 68-71 Lazer models available on request					
					

LIMIT & PRESSURE SWITCHES & SENSORS











SLOT SENSORS IP65			ULTRASONIC FORK SENSOR IP54			
Slot Sensor <b>SR23 SERIES</b>	<b>SR23 Series 5mm</b>		Slot Sensor <b>SRX3 SERIES</b>	<b>SRX3 Series 3mm</b> <b>For Transparent Label Detection</b>		
<ul style="list-style-type: none"> <li>Setting: Auto Set Push-Button</li> <li>Output: NPN &amp; PNP</li> </ul> <p><i>For sensor cable and accessories see pages 68-71</i></p>						
Switching Speed	12 kHz	12 kHz	Switching Speed	500Hz		
DC Supply voltage	10-30VDC	10-30VDC	DC Supply Voltage	10-30VDC		
Emission	Infrared LED 850nm	Infrared LED 850nm	Emission	Ultrasonic		
Resolution	0.5mm	0.5mm	Max tape Speed	300m/min		
Output LED	Yellow. Green (Ready)	Yellow. Green (Ready)	Settings	Dynamic/Static Teach-in		
Output current	100mA	100mA	Output LED	Yellow		
Saturation voltage	2v	2v	Output Current	250mA		
Response Time	40us	40us	Output	PNP/NPN		
Electrical Protection	class 2	class 2	Response Time	1ms		
Housing Material	Zinc Alloy	Zinc Alloy	Housing Material	Aluminium		
Operating temperature	-25° to 55°C	-25° to 55°C	Ingress Protection	<b>IP54</b>		
Connection	2m Cable	M8 4-pole	Connections	M12 5-Pole Connector	M8 4-Pole Connector	
<b>Wiring Diagrams</b>	<p><b>Cable</b></p> <p>BROWN 1 +10...30 VDC WHITE 2 REMOTE BLACK 4 OUTPUT BLUE 3 0 V</p>	<p><b>M8 Connector</b></p> <p>REMOTE (WHITE) 2 ● 4 ● OUTPUT (BLACK) 1 ● 3 ● 10...30VDC+ (BROWN) 1 ● 3 ● 0V (BLUE) 2 ● 4 ●</p>	<b>Wiring Diagrams</b>	<p><b>M12 Connector - 5 Pin</b></p> <p>Q-NPN (NPN) 1 ● 2 ● +10...30 VDC 3 ● 4 ● 0V 5 ● Q-NPN (PNP) 1 ● 2 ●</p>	<p><b>M8 Connector - 8 Pin</b></p> <p>Q-NPN (NPN) 1 ● 2 ● 4 ● 5 ● Q-NPN (PNP) 3 ● 6 ● +10...30 VDC 7 ● 8 ● 0V 1 ● 3 ●</p>	
<b>OUTPUT:</b>			<b>OUTPUT:</b>			
NPN	SR23-2-IR-NH	SR23-5-IR-NH	PNP/NPN Dynamic	SRX3-5-US-M12-PNH	SRX3-6-US-M8-PH	
PNP	SR23-2-IR-PH	SR23-5-IR-PH	PNP/NPN Static	SRX3-5-US-3-M12-PNH	SRX3-6-US-3-M8-PH	

ULTRASONIC SENSORS FOR MEASUREMENT AND INSPECTION IP67					
Type DC <b>US SERIES</b>	<b>M18</b>	<b>M30</b>		<b>M50</b>	
<ul style="list-style-type: none"> <li>Nominal Voltage: 10-30VDC</li> <li>Output: NPN &amp; PNP / 0-10VDC / 4-20mA</li> <li>Output Current: 100mA max.</li> <li>Complete Range</li> </ul>					
Sensing Distance	30-300mm	100-1000mm	200-2000mm	0.2-8m	
Setting	Teach-in Or Remote Input			Teach-in Push button / Remotely / Analogue Push Button	
Output LED	Yellow-Green Output / Red Power	Yellow Output / Green Power ON / Red Signal		Green Power On / Red Signal / Yellow, Red Output	
Housing Material	Polyester	PBT		ABS Polycarbonate	
Operating Temperature	-25° to 55°C	-40° to 70°C		-20° to 70°C	
Connections	M12 5-pole Connector	M12 4-pole Connector		M12 5-pole Connector	
<b>Wiring Diagrams</b>	<p>BROWN 1 + 10...30 Vdc</p> <p>WHITE 2 PNP Output</p> <p>BLACK 4 NPN Output</p> <p>GREY 5 REMOTE TEACH (0...2 Vdc)</p> <p>BLUE 3 0 V</p> <p>BROWN 1 + 10...30 Vdc</p> <p>BLUE 3 0 V</p> <p>WHITE 2 4...20 mA or 0...10 Vdc</p> <p>BLACK 4 5...30 Vdc (Pnp) / 0...2 Vdc (Pnp)</p> <p>GREY 5 REMOTE TEACH (0...2 Vdc)</p>	<p><b>M12 4-POLE CONNECTOR</b></p> <p>Analogue</p> <p>BROWN 1 + 10...30 VDC</p> <p>BLUE 3 0 V</p> <p>WHITE 2 REMOTE</p> <p>BLACK 4 ANALOGUE OUTPUT (4...20 mA / 0...10 V)</p> <p>Digital</p> <p>BROWN 1 + 10...30 VDC</p> <p>BLUE 3 0 V</p> <p>WHITE 2 REMOTE</p> <p>BLACK 4 NPN/PNP OUTPUT</p>		<p><b>M12 5-POLE CONNECTOR</b></p> <p>Analogue</p> <p>BROWN 1 + 10...30 VDC</p> <p>BLUE 3 0 V</p> <p>WHITE 2 ANALOGUE OUTPUT (4...20 mA / 0...10 V)</p> <p>BLACK 4 REMOTE TEACH</p> <p>Digital</p> <p>BROWN 1 + 10...30 VDC</p> <p>BLUE 3 0 V</p> <p>WHITE 2 LOAD1 Select NPN or PNP with Dipswitch</p> <p>BLACK 4 LOAD2</p> <p>GREY 5 REMOTE TEACH 0...2 VDC</p>	
<b>OUTPUT:</b>					
NPN & PNP	US18-PA*-5-N03-OH	US30-PR-5-N13-OH	US30-PR-5-N23-OH	US50-PR-5-N43-OH	
Analogue Output 0 - 10 VDC	US18-PA*-5-N03-VH	US30-PR-5-N13-VH	US30-PR-5-N23-VH	US50-PR-5-N43-IVH	
Analogue Output 4 - 20 mA	US18-PA*-5-N03-IH	US30-PR-5-N13-IH	US30-PR-5-N23-IH	(0-10V / 4-20mA Configurable Output)	
	* For radial type replace A with R e.g. US18-PR-5-N03-OH For M12 5-Pole plug and cable use part number CS-A1-03-G-03				

LIMIT &amp; PRESSURE SWITCHES &amp; SENSORS



## TIME OF FLIGHT LASER MEASUREMENT DISTANCE SENSORS IP67

Type DC	Analogue Distance S80 Series	Analogue Distance S80 Series	Analogue Distance S80 Series	Analogue Distance S81 Series <i>Cost Effective</i>	Analogue Distance S85 Series
  					
Distance	0.3-4m	0.3-20.3m (on R80 reflector)	0.3-100.3m (on R80 reflector)	0.3-4m	0.2-10m (Y03 mod) & 0.3-20m (Y13 mod)
Supply Voltage	15-30VDC	15-30VDC	15-30VDC	24VDC +/-20%	24VDC
Resolution	0.9mm	0.6mm	6mm		1mm
Light Emission	Red Laser cl.2	Red Laser cl.2	Red Laser cl.2	Red Laser 665nm, cl.2	Red Laser cl.2
Serial Interface	RS485	RS485	RS485	-	RS485 (Y13 Model)
Settings	Teach-in push-button	Teach-in push-button	Teach-in push-button	Teach-in push-button	Push Buttons & Display*
Outputs	2 x PNP 4-20mA analogue	2 x PNP 4-20mA analogue	2 x PNP 4-20mA analogue	2PNP or NPN outputs (only S81...M) 1analogue 0-10V output (S81...Y)	PNP,NPN Push Pull / Q & 4-20mA & 0-10V
Connection	M12 8-pole connector	M12 8-pole connector	M12 8-pole connector	M12 5-pole connector	M12 5-Pole(Y03), M12 8-Pole (Y13)
Electrical Protection	Class 2	Class 2	Class 2	Class 2	Class 2
Housing Material	Aluminium	Aluminium	Aluminium	ABS	Zinc Alloy
Operating Temperature	-10° to 50°C	-10° to 50°C	-10° to 50°C	-10° to 50°C	-10° to 50°C
					*Only for Y13 models

**OUTPUT:**

2 x PNP 4 - 20mA	<b>S80-MH-5-Y09-PPIZ</b>	<b>S80-MH-5-Y19-PPIZ</b>	<b>S80-MH-5-Y29-PPIZ</b>	-	-
2 x PNP 1 x PNP Alarm	Background suppression	-	-	<b>S81-PL-5-M03-PP*C</b>	-
2 x PNP 0-10V Analogue	-	-	-	<b>S81-PL-5-Y03-PP*V</b>	-
2 x PNP Scalable 0-10V Analogue	-	-	-	<b>S81-PL-5-Y03-PPVK</b>	-
Push Pull / Q & 4-20mA	-	-	-	-	<b>S85-MH-5-Y03-OOI</b>
PNP,NPN,Push Pull,Q,Q, 0-10v and 4-20mA	-	-	-	-	<b>S85-MH-5-Y13-OOIVY</b>

**Wiring Diagrams**

\*For NPN replace **PP** with **NN**  
E.g. **S80-NG-5-Y09-NN**

For plug and cable use part no.  
**CS-A1-06-B-03/10**. Use only **R80** reflector  
(03 = 3m Cable. 10 = 10m Cable)

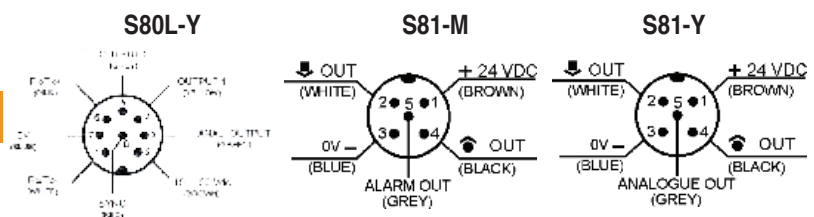

**NEW**

## FIBRE LASER MARKER 20W WITH 160S

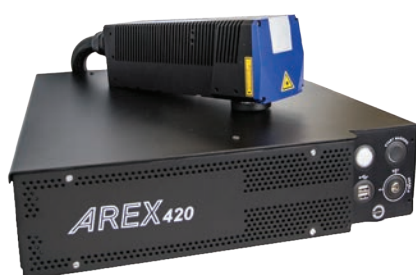

<b>Code</b>	<b>AREX-120-364</b>
Marking Area mm <sup>2</sup>	100 x 100
Fixing Distance	197mm
Working Distance	183mm
Power Supply	100/240VAC - 50/60Hz - 400W (Max)
Interfaces	6 x USB, 3 x Ethernet, 1 x RS-232, Digital I/O
Protection Rating	Head: IP64, Controller: IP31
Cooling	Low Noise, Forced Air
Head Dimension/Weight	89 x 96 x 311mm / 3kg
Controller Dimensions	427 x 111 x 435mm / 16kg

# DC FIBRE OPTIC AMPLIFIER IP67 DIN RAIL

Type DC	Through Beam + Proximity	Through Beam + Proximity	Through Beam + Proximity
<b>S7 SERIES</b> <ul style="list-style-type: none"> <li>• 10 bit resolution models with 500µs response for high operating distances</li> <li>• 12 bit resolution models with 50µs response and 4 digit display for high speed</li> <li>• Cost-effective models with multiturn trimmer adjustment</li> <li>• EASYtouch™ push-button setting with remote control, keylock and output delay</li> <li>• Ultra-thin housing with CLEARLOCK™ patented fibre fixing system</li> </ul>			
Switching Frequency	1KHz	5KHz	10KHz
Sensing Distance	100mm Prox. 300mm Through Beam	50mm Prox. 300mm Through Beam	25mm Prox. 75mm Through Beam
DC Supply Voltage	12-24VDC ±10%	12-24VDC ±10%	12-24VDC ±10%
Emission	Red LED 670nm	Red LED 670nm	White LED 460-630nm
Setting	Teach-in push-button	Teach-in push-button	Teach-in push-button
Output LED	Yellow/Green/Red error	Yellow/Green/Red error	Yellow/Green/Red error
Output	PNP or NPN	PNP or NPN	PNP or NPN
Contact	NO	NO	NO
Output current	≤100ma	≤100ma	≤100ma
Saturation Voltage	≤2V	≤2V	≤2V
Response Time	500µS	100µs	500µs
Timing Function	20ms minimum out ON	20ms minimum out ON	20ms minimum out ON
Operation Mode	light with EASYtouch™	light with EASYtouch™	light with EASYtouch™

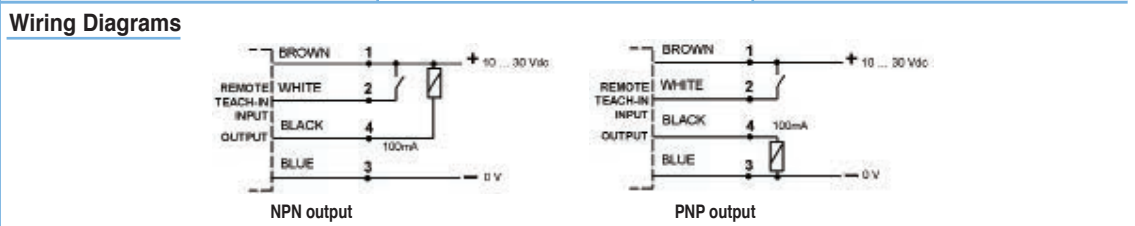

**OUTPUT:**

PNP NO M8 Plug	S7-6-E-P	-	-
NPN NO M8 Plug	S7-6-E-N	-	-
PNP NO M8 Plug Display	-	S7-5-E-P	-
NPN NO M8 Plug Display	-	S7-5-E-N	-
PNP NO Cable Display	-	S7-2-E-P	S7-1-E-P
NPN NO Cable Display	-	S7-2-E-N	S7-1-E-N

For plug and cable use part number CS-B1-02-G-05/03 (03 = 3m Cable, 05 = 5m Cable)

**Fibre Optic Cables**

Optic Function	Terminal/Tips	Fibre Type	Length	Part Number
Coaxial Proximity	M6 x 1mm	Standard 1mm	2m	OF-36-ST-20
Proximity	M6 x 1mm	Standard 1mm	1m	OF-18-ST-10
Proximity	M6 x 1mm*	Standard 1mm	2m	OF-22-ST-20
Proximity	M3 x 0.5mm	Thin 0.5mm	1m	OF-26-TN-10
Proximity	M6 x 0.75mm	Standard 1mm	1m	OF-42-ST-20
Proximity	M6 x 0.75mm	High Efficiency 1.5mm	2m	OF-42-HP-20
Through Beam	M4 x 0.7mm	Standard 1mm	1m	OF-19-ST-10
Through Beam	M4 x 0.7mm*	Standard 1mm	2m	OF-23-ST-20
Through Beam	M2 x 0.4mm	Thin 0.5mm	1m	OF-25-TN-10
Through Beam	M4 x 0.7mm	Standard 1mm	1m	OF-43-ST-20
Through Beam	M4 x 0.7mm	High Efficiency 1.5mm	2m	OF-43-HP-20



**Stainless Steel Protective Metal Sheath 2m**

Part Number	Suitable Fibres
AF-7	M6 x 0.75mm fibres OF-42-xx
AF-9	M4 x 0.7mm fibres OF-43-xx**

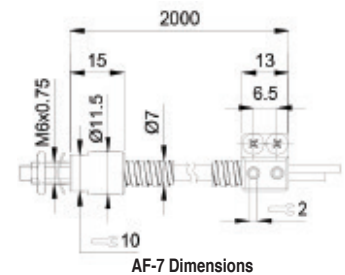

AF-7 Dimensions

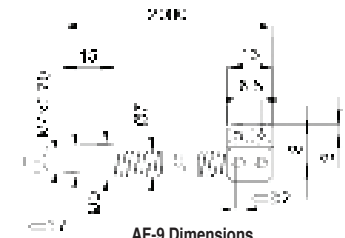

AF-9 Dimensions

**Application Fibre Optics**

Optic Function	Terminal/Emission	Fibre Length	Part Number
Through Beam	Axial, 16 Beam Array	2m	OFA-1-AE-20
Through Beam	Radial, 16 Beam Array	2m	OFA-1-AS-20
Proximity	Axial, 32 Beam Array	2m	OFA-2-AE-20
Proximity	Radial, 32 Beam Array	2m	OFA-2-AS-20



\* A bendable stainless steel extension 90mm long protrudes from the threaded optic head \*\* 2 Sheaths have to be ordered for both the emitter-receiver fibres

standard fibre-optics



## LONG RANGE PHOTOELECTRIC SENSORS IP54

Type	Through Beam Kits			Accessories for P40
<p>• Included: Receiver &amp; Emitter • Emission: Infrared (875nm) • Ambient: -20° to 60° C • Light Immunity: &gt;5000 Lux</p>	<p style="text-align: center;">Receiver      Emitter</p> <p style="text-align: center;"><b>P40</b> – flush mount</p>		<p style="text-align: center;">Receiver      Emitter</p> <p style="text-align: center;">Battery operated 9V emitter - 150 days min. Solar cell power supply on request</p>	<p style="text-align: center;"><b>C340</b></p>
	<p>Switching Distance</p> <p>Output</p> <p>Consumption</p> <p>12-24VAC/DC</p> <p>9V Alkaline Battery <b>P44</b></p>	<p style="text-align: center;">55M</p> <p style="text-align: center;">Relay: 1A @ 24VDC</p> <p style="text-align: center;">40mA</p> <p style="text-align: center;"><b>P40</b></p>		<p style="text-align: center;">15M</p> <p style="text-align: center;">2 Relay</p> <p style="text-align: center;">70mA</p> <p style="text-align: center;"><b>P44</b></p>

## ROTARY ENCODERS

Autonics Sensors & Controllers	40mm Hollow Shaft Encoder (Incremental Type)	250mm Wheel Type Encoder 250 Pulses/Revolution (Incremental Type)	250mm Wheel Type Encoder 25 Pulses/Revolution (Incremental Type)	250mm Wheel Type Encoder 1 Pulse / 4 Revolutions (Incremental Type)				
<b>Type</b>	<b>Code</b>	<b>Supply Volts</b>	<b>Code</b>	<b>Supply Volts</b>	<b>Code</b>	<b>Supply Volts</b>	<b>Code</b>	<b>Supply Volts</b>
Totem Pole Output	<b>E40H**-3-T-24</b>	12-24VDC	<b>ENC-1-1-T-24</b>	12-24VDC	<b>ENC-1-2-T-24</b>	12-24VDC	<b>ENC-1-3-T-24</b>	12-24VDC
NPN NO Output	<b>E40H**-3-N-24</b>	12-24VDC	<b>ENC-1-1-N-24</b>	12-24VDC	<b>ENC-1-2-N-24</b>	12-24VDC	<b>ENC-1-3-N-24</b>	12-24VDC
Line Driver Output	<b>E40H**-6-L-5</b>	5VDC						
Gear Ratio	-		1:1		4:1		4:1	
Shaft Size (mm)	6 / 8 / 10 / 12mm		1mm		1cm		1m	
Max. Response Freq.	300kHz		180kHz		180kHz		180kHz	

\* Add shaft size to code: **6, 8, 10, 12**

\*\* Add pulses/revolution to code: **20, 50, 75, 100, 125, 150, 200, 250, 360, 500, 1000, 1024, 1800, 2048, 2500, 3600, 5000**

	20mmØ, Shaft Type Encoder (Incremental Type)	40mmØ, Shaft Type Encoder (Incremental Type)	50mmØ, Shaft Type Encoder (Incremental Type)			
<p style="text-align: center;">Coupling</p> <p><b>Code</b></p> <p><b>E4DC-6/6</b> <b>E5DC-8/8</b> <b>E5DC-10/10</b></p>						
<b>Type</b>	<b>Code</b>	<b>Supply Volts</b>	<b>Code</b>	<b>Supply Volts</b>	<b>Code</b>	<b>Supply Volts</b>
Totem Pole Output (HTL)	<b>E20S2*-3-V-R</b>	12-24VDC	<b>E40S6*-3-1</b>	12-24VDC	<b>E50S8*-3-1</b>	12-24VDC
NPN N/O Output (TTL)	<b>E20S2*-3-N-R</b>	12-24VDC	<b>E40S6*-3-2</b>	12-24VDC	<b>E50S8*-3-2</b>	12-24VDC
Line Driver Output (TTL)	<b>E20S2*-3-L-R</b>	5VDC	<b>E40S6*-6-L</b>	5VDC	<b>E50S8*-6-L</b>	5VDC
Pulses/Revolution	*Add to code: <b>*100, 200, 320, 360</b>		*Add to code: <b>*100, 360, 500, 1000, 1024</b>		*Add to code: <b>*50, 100, 200, 250, 360, 1000, 1024, 1800, 2500, 3600</b>	

### Specifications

Shaft	2mm	6mm	8mm
Totem Pole Output	Low ⚡ Load current: Max. 30mA, Residual voltage: Max. 0.4V High ⚡ Load current: Max. 10mA, Output Voltage: Min. 1.5V		
NPN Open Output	Load Voltage: Max. 30V, Load current: Max. 30mA, Residual Voltage: Max. 0.4V		
Line Driver Output	Low ⚡ Load current: Max. 20mA, Residual Voltage: Max. 0.5V High ⚡ Load current: Max. -20mA, Output Voltage: Min. 2.5V		
Max. Response Freq.	100kHz		180kHz

# INCREMENTAL AND ABSOLUTE OPTICAL ROTARY ENCODERS

	Basic Line Incremental 41mmØ	Extended Line Incremental 58mmØ	SSI Single-turn Absolute 58mmØ
Power Supply	5–30VDC	5–30VDC	7.5–34VDC
Resolution	Up to 4096 PPR	Up to 10000 PPR and programmable	13 bit = up to 8192 count per revolution (CPR)
Output Signals/ Code	AB0 and /A/B/0	AB0 and /A/B/0	Gray
Output Circuit	Smart Push-Pull & Line Driver	Smart Push-Pull & Line Driver	SSI® (RS422) tree format
Consumption	50mA max.	70mA max.	0.9W
Output Current	40 mA max (per channel)	40 mA max (per channel)	-
Connection	Cable 1.5m	Cable 1.5m or connector M12 or M23	Cable 1.5m or connector M12 or M23
Shaft Dimension	Hollow or Solid Shaft Ø6mm	Hollow Ø14 or 15mm, solid Ø6 or Ø10mm	Hollow Ø15mm, solid Ø6 or Ø10mm
Case Dimension	Ø40.5mm, depth 34mm	Ø58mm, depth 54mm	Ø58mm, depth 48mm

Part Numbers			
Hollow Shaft Ø6/14/15mm	<b>ENC41-H06-**-C15</b>	<b>ENC58-H14***-C15-***</b>	<b>AST58-H15-13X01-C15-***</b>
Solid Shaft Ø6/10mm	<b>ENC41-S06-**-C15</b>	<b>ENC58-S06^**-C15-***</b>	<b>AST58-S06^1-13X01-C15-***</b>

\*For Ø15mm shaft use 15 e.g. **ENC58-H15**. ^ For Ø10mm shaft use 10 e.g. **ENC58-S10** or **AST58-S10** or **AMT58-S10**

\*\*Add pulses/revolution: **0100, 0360, 0500, 1000, 1024, 2048, 4096**.

\*\*\*Add pulses/revolution: **0500, 1000, 1024, 2000, 2048, 5000, 10000, PROG.** (only available M23 Connector)

\*\*\*Add connector type to code: **M12** or **M23**

## Wiring Diagrams

Electrical Connections: ENC41-S/H									
Signals	A	/A	B	/B	0	/0	+VDC	0VDC	Shield
AB0/AB0 outputs (8-wire cable)	Green	Yellow	Grey	Pink	Blue	Red	Brown	White	Shield

Electrical Connections: ENC58-S/H									
Signals	A	/A	B	/B	0	/0	+VDC	0VDC	Shield
M12 8-pin	3	4	5	6	7	8	2	1	Case
M23 12-pin	3	4	5	6	7	8	2	1	Case
AB0/AB0 outputs (8-wire cable)	Green	Yellow	Grey	Pink	Blue	Red	Brown	White	Shield

SSI Serial Connections: AMT/AST58-H/S			
Signals	M23 12-pin	M12 8-pin	Cable
0V	1	1	White
+VDC	2	2	Brown
Clock In+	3	3	Green
Clock In-	4	4	Yellow
Data Out+	5	5	Grey
Data Out-	6	6	Pink
Preset	7	7	Blue
Count dir.	8	8	Red
Shield	Case	Case	Shield

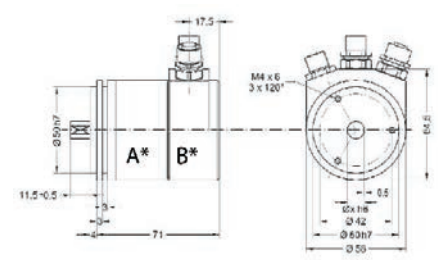

## CANopen or Devicenet

**EtherCAT**

M12 5-pin I/O	Case	1
CAN Shield	+	2
+10...30Vdc	-	3
0Vdc	H	4
CAN High	L	5

M12 4-pin PS	1
+10...30Vdc	1
n.c.	2
0Vdc	3
n.c.	4

M12 4-pin I/O	1
TX Data +	1
RX Data +	2
TX Data -	3
RX Data -	4

## Profibus-DP

M12 3-pin	1
+10...30Vdc	1
0Vdc	3
Shield	4

M12 5-pin I/O	1
n.c.	1
Profibus A	Green 2
n.c.	3
Profibus B	Red 4
n.c.	5

**M12 8-pin**

**M23 12-pin**

**PROFINET PORT 1**  
M12 4-pin female

M12 4-pin P1	1
TX Data +	1
RX Data +	2
TX Data -	3
RX Data -	4



**POWER SUPPLY**  
M12 4-pin male

M12 4-pin P5	1
+10...30Vdc	1
n.c.	2
0Vdc	3
n.c.	4

**PROFINET PORT 2**  
M12 4-pin female

M12 4-pin P2	1
TX Data +	1
RX Data +	2
TX Data -	3
RX Data -	4

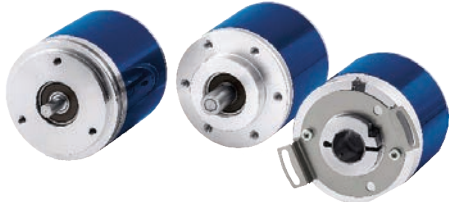
## SSI AND FIELDBUS ABSOLUTE OPTICAL ROTARY ENCODERS

SSI Multi-turn Absolute 58mmØ	Multi-turn with Integrated Fieldbus Absolute 58mmØ	Multi-turn with Modular Fieldbus Interface Absolute 58mmØ
		
7.5-34VDC 13 x 12 bit = up to 8192 CPR x 4096 turns	7.5 - 34VDC 13 x 12 bit = 8192 CPR x 4096 turns / 13 x 14 bit = 8192 CPR x 16384	7.5-34VDC 16 x 14 bit = up to 65536 CPR x 16384 turns
Gray SSI® (RS422) tree format	- Canopen, Devicenet, Ethercat, Profibus, Profinet	- Fieldbus interface module
1W	2.2W	2.2W
-	-	-
Cable 1.5m or connector M12 or M23	M12 Connector	M12 connectors
Hollow Ø15mm, solid Ø6 or Ø10mm	Hollow Ø15mm, solid Ø10mm	Hollow Ø15mm, solid Ø6 or Ø10mm
Ø58mm, depth 48mm	Ø58mm, dept 71mm, (encoder + interface module)	Ø58mm, depth 71mm (encoder + interface module)

### Part Numbers

<b>AMT58-H15-13X12-C15***</b>	<b>AMT58-H15-13X12-PB◇</b>	<b>AMT58-H15-13X14-PN#</b>	<b>AMT58-H15-16X4-FBUS</b>
<b>AMT58-S06^1-13X12-C15***</b>	<b>AMT58-S10-13X12-PB◇</b>	<b>AMT58-S15-13X14-PN#</b>	<b>AMT58-S06^1-16X4-FBUS</b>

### ACCESSORIES FOR FIELDBUS ENCODERS

Code	Description
<b>CN-M12-CB/DN-KIT</b>	Canopen/ Devicenet 2 connectors kit
<b>CN-M12-5P-5M-CB/DN-O</b>	Canopen/ Devicenet output cable 5m
<b>CN-M12-5P-5M-CB/DN-I</b>	Canopen/ Devicenet input cable 5m
<b>CN-M12-PBUS-KIT</b>	Profibus 3 connectors kit
<b>CN-M12-4P-5M-BUS-PS</b>	Pbus/Ecat/Pnet power supply cable 5m
<b>CN-M12-5P-5M-PBUS-I</b>	Profibus input cable 5m
<b>CN-M12-5P-5M-PBUS-O</b>	Profibus output cable 5m
<b>CN-M12-4P-5M-EC/PN-RJ</b>	Ethercat/Profinet programming cable 5m
<b>CN-M12-4P-5M-EC/PN-IO</b>	Ethercat/Profinet input-output cable 5m
<b>CN-M12-4P-00-EC/PN-IO</b>	Ethercat/Profinet input-output plug

### FIELDBUS INTERFACE MODULES

CANopen interface module*	<b>AMT58-FBUS-CB</b>
Devicenet interface module*	<b>AMT58-FBUS-DN</b>
Profibus DP interface module*	<b>AMT58-FBUS-PB</b>

\*The encoder base unit must be ordered with the **FIELDBUS** interface module. The encoder base unit must be connected to the required **FIELDBUS** interface module

◇ For Canopen type replace **PB** with **CB**.  
For Devicenet type replace **PB** with **DN**

# For Ethercat replace **PN** with **EC**  
Fieldbus Encoders only available ex-indent

## ACCESSORIES FOR ENCODERS

### Aluminium and Plastic Couplings Ø6mm & Ø10mm

Code	FAC06-06	FBC06-06	FAC10-10	FBC10-10
Diameter	Ø6mm	Ø6mm	Ø10mm	Ø10mm

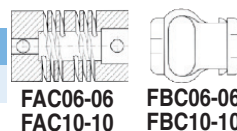

### Encoder Reducing Sleeve

Code	<b>RS15-06*</b>
	* For 8 / 10 / 11 / 12mm use <b>08, 10, 11, 12</b>

### Encoder Mounting Brackets for Ø58 Encoders

Code	ST-58-KIT	ST-58-BELL	ST-58-BRKT	ST-58-FLNG
Type	Fixing Clamps	Mounting Bell	L-Bracket	Flange

### Cables & Connectors

Code	Description
<b>CS-A1-06-U-05*</b>	M12 8 Pin 5m cable
<b>CN-M23^1-12P-05*</b>	M23 12 Pin 5m cable
<b>CS-A1-06-B-NC</b>	M12 8 Pin connector no cable
<b>CN-M23-12P-00</b>	M23 12 Pin connector no cable

^For Absolute Encoder Plug and Cable Add A / \*For 10m Cable replace 05 with 10

Code	Description
<b>OEK-4</b>	Encoder Kit PNP 250PPR. Bracket, Spring and Wheel
<b>IEP58-PROG-TOOL</b>	Programming tool for <b>ENC58</b>
<b>CN-M12-PROG-CABLE</b>	M12 Cable for Programming Tool
<b>CN-M23-PROG-CABLE</b>	M12 Cable for Programming Tool
<b>DWA*-5000</b>	Draw Wire

\*For integral encoder replace **A** with **I**

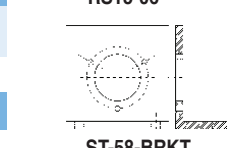
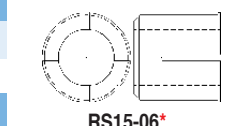



# FINGER, HAND AND BODY PROTECTION SAFETY LIGHT CURTAINS IP65

Type 2 or 4	SG4 BASE	SG2 BASE	SG2 Extended
<p>• According to IEC61496-1 and EIC61496-2</p> <p><b>Note:</b> For Safety Light Curtain selection guide see Datalogic Short Form Catalogue</p>	<p>• High reliability • Easy installation and alignment • Cost effective solution</p>	<p>• High reliability • Easy installation and alignment • Cost effective solution</p>	<p>• High reliability • Easy installation and alignment • Cost effective solution</p>
Sensing Distance	6m      19m	19m	Selectable 9m or 19m
Power Supply	24VDC	24VDC	24VDC
Resolution (mm)	14mm      30mm	30mm	30mm
Controlled Height	150-1800mm	150-1800mm	150-1800mm
Response Time	10-51ms      9-28ms	8-24ms	8-24ms
Output	2 x PNP transistors	2 x PNP transistors	2 x PNP transistors
Connection	Rx: M12 8-Pole, Tx M12 4-Pole	Rx: M12 5-Pole Tx: M12 4-Pole	Rx: M12 8-Pole Tx: M12 4-Pole
Profile (mm)	32 x 37	32 x 37	32 x 37
Device Settings			
Device Function	Reset Test, Manual/Auto Restart selection, EDM selection		Test, Manual/Automatic Restart Selection
Plus Functions		Test, Automatic Restart	EDM Selectable. Selectable max distance 9m or 19m

### Controlled Height/Beams <sup>^</sup>

150mm	SG4-14-015-00-E	SG4-30-015-00-E	SG2-30-015-00-X	SG2-30-015-00-E-C
300mm	SG4-14-030-00-E	SG4-30-030-00-E	SG2-30-030-00-X	SG2-30-030-00-E-C
450mm	SG4-14-045-00-E	SG4-30-045-00-E	SG2-30-045-00-X	SG2-30-045-00-E-C
600mm	SG4-14-060-00-E	SG4-30-060-00-E	SG2-30-060-00-X	SG2-30-060-00-E-C
750mm	SG4-14-075-00-E	SG4-30-075-00-E	SG2-30-075-00-X	SG2-30-075-00-E-C
900mm	SG4-14-090-00-E	SG4-30-090-00-E	SG2-30-090-00-X	SG2-30-090-00-E-C
1050mm	SG4-14-105-00-E	SG4-30-105-00-E	SG2-30-105-00-X	SG2-30-105-00-E-C
1200mm	SG4-14-120-00-E	SG4-30-120-00-E	SG2-30-120-00-X	SG2-30-120-00-E-C

<sup>^</sup>Units with even longer controlled heights available on request. For safety accessories see pages 50-51

## CABLES FOR ALL SAFETY LIGHT CURTAINS

### Cables - for SG4 BASE, SG2 BASE & SG2 EXTENDED

Light Curtain Series	Transmitter Cable Code	Description
<b>SG4 BASE</b> (SG4-xx-xxx-00-X)	<b>CS-A1-02-U-03/10/15/25</b> (03 = 3m, 10 = 10m, 15=15m, 25=25m Cable)	4 Pole 3m Cable
<b>SG2 BASE</b> (SG2-xx-xxx-00-X)		4 Pole 5m Cable
<b>SG2 EXTENDED</b> (SG2-xx-xxx-00-E-C)	<b>CS-A1-02-U-05</b>	4 Pole 5m Cable

The above cables are also used with single beam safety sensors

Light Curtain Series	Receiver Cable Code	Description
<b>SG2 BASE</b> (SG2-xx-xxx-00-X)	<b>CS-A1-06-U-03</b>	8 Pole 3m Cable
<b>SG2 EXTENDED</b> (SG2-xx-xxx-00-E-C)	<b>CS-A1-06-U-05</b>	8 Pole 5m Cable
<b>SG4 BASE</b> (SG4-xx-xxx-00-E)	<b>CS-A1-03-U-03</b>	5 Pole 3m Cable
	<b>CS-A1-03-U-05</b>	5 Pole 5m Cable

Note: All cables have axial connectors

Note: The Cable Chart is also to be used with **SG2-B/E-50/90** on page 319











Cable Connectors

### Cables - for SG2 MUTING & SG4 EXTENDED

Light Curtain Series	Transmitter/Receiver Main Connector	Pigtail Cable/Interface Code	Length
<b>SG2 MUTING</b> (SG2-30-xxx-00-W)	Transmitter	<b>CS-G1-50-B-002</b>	0.2m
	Receiver	<b>CS-G1-70-B-002</b>	0.2m
<b>SG4 EXTENDED</b> (SG4-xx-xxx-00-P)	Transmitter	<b>CS-G1-50-B-002</b>	0.2m
	<b>Blanking Configuration</b>		
	Receiver	<b>CS-G1-70-B-002</b>	0.2m
	<b>Muting Configuration</b>		
Receiver	<b>CS-R1-75-B-002</b>	0.2m	
<b>Dongle</b>			
Receiver	<b>SG4-DONGLE</b>	-	

Note: 1) The light curtain is sold without pigtail cables: they must be ordered separately for Transmitter and Receiver. 2) For **SG4 EXTENDED**, the pigtail cable used determines if the light curtain will work in Muting configuration or in Blanking configuration. If, in place of the pigtail cable, the Dongle is used for receiver, the light curtain can work in both configurations. When muting and blanking are not needed, Dongle or pigtail cable **CS-G1-70-B-002** are suggested. 3) If **SG4 EXTENDED** receiver is connected to the programming and monitoring interface (**DONGLE**), the pigtail cable for Receiver isn't needed.

## PROGRAMMABLE, MUTING AND BLANKING TYPES IP65

SG4 Extended Programable***		SG2-M-30 Muting	Type 2 or 4 SERIES	SG Body Compact Base	SG Body Compact Muting
 <p>• State of the art technology • Complete diagnostics and online monitoring</p> 		 	<p>• According to IEC61496-1 &amp; EIC61496-2</p> <p>Note: For Safety Light Curtain selection guide see Datalogic Short Form Catalogue</p> 	 	<p>• Integrated muting lamp • L and T muting models provided with retroreflective muting arms</p>  
7m (14mm) 20m	20m	20m	Sensing Distance	50m	50m (SG-S) 3m (SG-T/L)
24VDC		24VDC	Power Supply	24VDC	24VDC
14mm 30m	30m	30mm	No. of beams	2-3-4	2-3-4
300-1800mm		300-1800mm	Resolution (mm)	500-800-900-1200mm	500-800-900-1200mm
No coding 15-33ms, coding 20-65ms		13-22ms	Controlled Height		500-800mm (L or T models)
2 x PNP/NPN configurable		2 x PNP transistors	Response Time	14-16ms	14-16ms
Rx: M12 12-Pole+M12 5-Pole for muting; M12 12-Poles for blanking, Tx: M12 5-Pole		Rx: M12 12-Pole+M12 5-Pole Tx: M12 5-Pole	Output	2 x PNP transistors	2 x PNP transistors
35 x 41 (ZERO DEAD ZONE)		35 x 41 (ZERO DEAD ZONE)	Connection	Rx: M12 8-Pole Tx: M12 4-Pole	Rx: M12 8-Pole+M12 5-Pole Tx: M12 4-Pole+M12 5-Pole
Basic Configuration Mode (BCM)*		Basic Configuration Mode (BCM)*	Profile (mm)	35 x 40	35 x 40
Advanced Configuration Mode (ACM)**		Test, Manual/Auto Restart Selection, EDM selection, Configurable Muting, Range Reduction	Device Settings	Dip-switches, present on the Receiver Guarantee rapid and safe device settings	Dip-switches, present on the Receiver Guarantee rapid and safe device settings
Reset, Restart selection, Alignment, EDM, Test, Muting, Partial Muting, Override, Coding, Range reduction, Fixed Blanking, Floating Blanking, Cascade, PNP/NPN output, GUI programming		Reduction Range, Alignment Aid	Device Function	Test, Manual/Auto Restart selection. EDM	One-way/Two-way Muting. Test Manual/Auto Restart selection. Muting time-out selection, EDM selection override
			Plus Functions		
			<b>Controlled Height/Beams ^ For safety accessories see pages 50-51</b>		
			500mm 2Beam	SG2**-S2-050-PP-E	SG2**-S2-050-PP-W
			800mm 3Beam	SG2**-S3-080-PP-E	SG2**-S3-080-PP-W
			900mm 4Beam	SG2**-S4-090-PP-E	SG2**-S4-090-PP-W
			1200mm 4Beam	SG2**-S4-120-PP-E	SG2**-S4-120-PP-W
			L Muting 515mm 2Beam		SG2**-L2-050-PP-W
			L Muting 815mm 3Beam		SG2**-L3-080-PP-W
			T Muting 915mm 2Beam		SG2-T2-050-PP-W
			T Muting 1215mm 3Beam		SG2-T3-080-PP-W
			T Muting 515mm 2Beam		SG4-T2-050-PP-W
			T Muting 815mm 3Beam		SG4-T3-080-PP-W
SG4-14-030-00-P	SG4-30-030-00-P	SG2-30-030-00-W	<b>** For type 4 units replace 2 with 4 e.g SG4-S3-050-PP-E or SG4-L2-050-PP-W</b>		
SG4-14-045-00-P	SG4-30-045-00-P	SG2-30-045-00-W	<b>^Units with even longer controlled heights available on request.</b>		
SG4-14-060-00-P	SG4-30-060-00-P	SG2-30-060-00-W			
SG4-14-075-00-P	SG4-30-075-00-P	SG2-30-075-00-W			
SG4-14-090-00-P	SG4-30-090-00-P	SG2-30-090-00-W			
SG4-14-105-00-P	SG4-30-105-00-P	SG2-30-105-00-W			
SG4-14-120-00-P	SG4-30-120-00-P	SG2-30-120-00-W			

## CABLES FOR ALL SAFETY LIGHT CURTAINS

Cables - for SG2 MUTING & SG4 EXTENDED (Continued)				Cables for SG BODY COMPACT BASE/MUTING - Main Connectors		
Light Curtain Series	Transmitter/Receiver Secondary Connector	Receiver Main Connector	Length	Light Curtain Series	Transmitter Cable	Description
SG2 MUTING (SG2-30-xxx-00-W) & SG4 EXTENDED (SG4-xx-xxx-00-P)	CS-A1-03-U-03	CS-A1-10-U-03	3m	BASE (SG2/4-Sx-xxx-PP-E)	CV-A1-22-B-03*	M12 Axial 4 Pole 3m Cable
	CS-A1-03-U-05	CS-A1-10-U-05	5m	MUTING (SG2/4-S/L/Tx-xxx-PP-W)	CV-A1-22-B-05	M12 Axial 4 Pole 5m Cable
	CS-A1-03-U-10	CS-A1-10-U-10	10m		CV-A2-22-B-03*	M12 Radial 4 Pole 3m Cable
	CS-A1-03-U-15	CS-A1-10-U-15	15m		CV-A2-22-B-05	M12 Radial 4 Pole 5m Cable
	CS-A1-03-U-25	CS-A1-10-U-25	25m			
	CS-A1-03-U-50	CS-A1-10-U-50	50m			
<p>*Push buttons located on both TX and RX allow the user to configure the device in a very easy and quick way</p> <p>**A GUI interface on PC communicate to the barrier through Ethernet and lead the customer through the configuration process step by step</p> <p>*** (1) The light curtain is sold without pigtail cables: they must be ordered separately for Transmitter and Receiver. (2) In the case of the SG4 EXTENDED, the choice of the Receiver pigtail determines if it will work in <b>Muting configuration</b> or in <b>Blanking configuration</b>. (3) In case the SG4 EXTENDED will be installed together with the programming and monitoring interface (DONGLE), the pigtail cable for Receiver isn't needed. See accessories table for more info on DONGLE</p> <p><b>Pigtail cable for receiver:</b> Muting CS-R1-75-B-002, Blanking CS-G1-70-B-002</p> <p><b>Pigtail cable for emitter:</b> Muting &amp; Blanking CS-G1-50-B-002</p>				<p><b>Light Curtain Series</b>    <b>Receiver Cable</b>    <b>Description</b></p> <p>BASE (SG2/4-Sx-xxx-PP-E)    CV-A1-26-B-03*    M12 Axial 8 Pole 3m Cable</p> <p>CV-A1-26-B-05    M12 Axial 8 Pole 5m Cable</p> <p>MUTING (SG2/4-S/L/Tx-xxx-PP-W)    CV-A2-26-B-03*    M12 Radial 8 Pole 3m Cable</p> <p>CV-A2-26-B-05    M12 Radial 8 Pole 5m Cable</p> <p>*For units with 10, 15, 25m cable add 10, 15 or 25 to part number</p> <p><b>- Secondary Connectors</b></p> <p><b>Light Curtain Series</b>    <b>Receiver Cable</b>    <b>Description</b></p> <p>MUTING (Linear) (SG2/4-S/L/Tx-xxx-PP-W)    CV-A1-03-U-03    M12 Axial 5 Pole 3m Cable</p> <p>CV-A1-03-U-05    M12 Axial 5 Pole 5m Cable</p> <p>Note: The cables for the secondary connector of SG BODY COMPACT MUTING T and L are provided within the package</p>		

LIMIT & PRESSURE SWITCHES & SENSORS

# PRESENCE CONTROL & REFLECTOR TYPE SAFETY LIGHT CURTAINS IP65

SERIES	SG2-B-50/SG2-B-90	SG2-E-50/SG2-E-90	SG4 Body Big Reflector Base	SG4 Body Big Reflector Muting
	Type 2	Type 2	Type 4	Type 4
<p>• According to IEC61496-1 and IEC61496-2</p> <p>Note: For Safety Light Curtain selection guide see Datalogic Short Form Catalogue</p>				
Sensing Distance	19m	Selectable 9m or 19m	Up to 8m	Up to 8m
Power Supply	24VDC	24VDC	24VDC	24VDC
Resolution/No. of beams	50/90mm	50/90mm	2-3-4	2-3-4 (linear)
Controlled Height	300-1800mm	300-1800mm	500-800-900-1200mm	2-3 (L or T) 500-800-900-1200mm 500-800 (Lor T)
Response Time	20-80ms (50 vers), 8-19ms (90 vers)	20-80ms(50 vers), 8-19ms (90 vers)	12ms	12ms
Output	2 x PNP	2 x PNP	2 x PNP transistors	2 x PNP transistors
Connection	Rx: M12 5-Pole Tx: M12 4-Pole	Rx: M12 8-Pole Tx: M12 4-Pole	Active units: M12 8-Pole Passive units: non connected	Active units: M12 5-Pole+M12 12-Pole, Passive units: non connected
Profile (mm)	32 x 37	32 x 37	52 x 57	52 x 57
Device Settings		**		Dip Switches
Device Function	Reset/Test/Auto Restart		Test, Manual/Auto Restart selection. EDM selection	Test, Manual/Auto Restart selection. EDM selection
Plus Functions				One-way or two-way Muting. Muting time-out selection. Muting enable. Muting filter. Edged/Triggered Override selection. Auto restart after override selection.

### Controlled Height/Beams ▲

			Active	Passive/Reflector	Active	Passive/Reflector
300mm 9 Beam	SG2-50*-030-00-X	SG2-50*-030-00-E-C				
450mm 13 Beam	SG2-50*-045-00-X	SG2-50*-045-00-E-C				
600mm 17 Beam	SG2-50*-060-00-X	SG2-50*-060-00-E-C				
750mm 21 Beam	SG2-50*-075-00-X	SG2-50*-075-00-E-C				
900mm 25 Beam	SG2-50*-090-00-X	SG2-50*-090-00-E-C				
1050mm 29 Beam	SG2-50*-105-00-X	SG2-50*-105-00-E-C				
1200mm 33 Beam	SG2-50*-120-00-X	SG2-50*-120-00-E-C				
500mm 2 Beam			SG4-RB2-050-00-E	SG4-RDB2	SG4-RB2-050-00-W	SG4-RDB2
800mm 3 Beam			SG4-RB3-080-00-E	SG4-RDB3	SG4-RB3-080-00-W	SG4-RDB3
900mm 4 Beam			SG4-RB4-090-00-E	SG4-RDB4-090	SG4-RB4-090-00-W	SG4-RDB4-090
1200mm 4 Beam			SG4-RB4-120-00-E	SG4-RDB4-120	SG4-RB4-120-00-W	SG4-RDB4-120
500mm L 2 Beam					SG4-RB2L-050-00-W	SG4-RDB2L
500mm T 2 Beam					SG4-RB2T-050-00-W	SG4-RDB2T
800mm L 3 Beam					SG4-RB3L-080-00-W	SG4-RDB3L
800mm T 3 Beam					SG4-RB3T-080-00-W	SG4-RDB3T

\* For units with 90mm resolution replace 50 with 90 e.g. SG2-90-030-00-X ▲Units with even longer controlled heights available on request.

Note: Active and Passive/Reflector units must be ordered separately to make up a set.

## CABLES FOR ALL SAFETY LIGHT CURTAINS

### Safety Muting Lamps



For Signal Towers please see AC/DC Main Catalogue pages 346-347



### Cables for SG BODY REFLECTOR BASE/MUTING - Main Connectors

Light Curtain Series	Active Unit Code	Description
SG BODY REFLECTOR BASE (SG4-RBx-xxx-00-E)	CS-A1-06-U-03	M12 8 Pole 3m Cable
	CS-A1-06-U-05	M12 8 Pole 5m Cable
	CS-A1-06-U-10	M12 8 Pole 10m Cable
SG BODY REFLECTOR MUTING (SG4-RBx-xxx-00-W)	CS-A1-10-U-03	M12 12 Pole 3m Cable
	CS-A1-10-U-05	M12 12 Pole 5m Cable
	CS-A1-10-U-10	M12 12 Pole 10m Cable

### - Secondary Connectors

Light Curtain Series	Active Unit Code	Description
SG BODY REFLECTOR MUTING (SG4-RBx-xxx-00-W)	CS-A1-03-U-03	M12 5 Pole 3m Cable
	CS-A1-03-U-05	M12 5 Pole 5m Cable
	CS-A1-03-U-10	M12 5 Pole 10m Cable



Axial Cable Connector



# SINGLE BEAM SAFETY PHOTOCELLS VDC PNP IP67

Safety Photocells				
SERIES	S5 Photo	SL5 Laser	S300 Photo	S300 Photo
	Type 2 or Type 4	Type 4	Type 2	Type 4
<ul style="list-style-type: none"> <li>• Emitter-receiver photocells with test input</li> <li>• Type 2 and Type 4 models</li> <li>• Plastic tubular and MAXI</li> <li>• Photocells with standard M12 connectors</li> <li>• IR emission models for distances reaching 8m, 40m, 50m</li> <li>• Class 1 laser emission models for distances reaching 40m</li> </ul>				
Sensing Distance	0-8m	0-40m	0-50m	0-40m
Power Supply	10-30VDC	10-30VDC	10-30VDC	10-30VDC
Emission	LED Infrared 880nm	Red Laser (650nm)*	LED Infrared 880nm	LED Infrared 880nm
Output	PNP (short circuit protection)		PNP NC open collector	
Output Current	100mA max		100mA resistive load	
Consumption (Excluding output)	30mA max	35mA max	F= < 25mA G= < 20mA	F= < 25mA G= < 20mA
Saturation Voltage	2V max	2V max	2.4V max	2.4V max
Response Time	1ms	1ms	1ms	1ms
Switching Frequency	500hz	500hz	500hz	500hz
Housing Material	ABS UL 94V-O		PBT 30% glass fibre-reinforced	
Mechanical Protection	IP67	IP67	IP67	IP67
Connections	M12 4-Pole Connector**	M12 4-Pole Connector**	Terminal Block	Terminal Block
Diagnostic functions	Test Input	Test Input	Test Input	Test Input
Weight	30g Max	30g Max	140g Max	140g Max

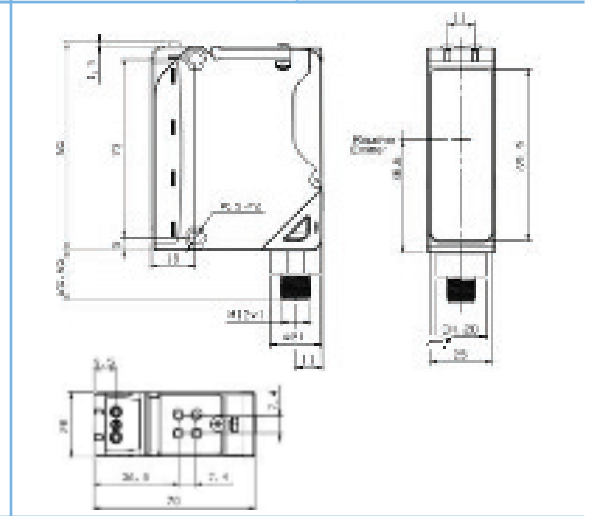
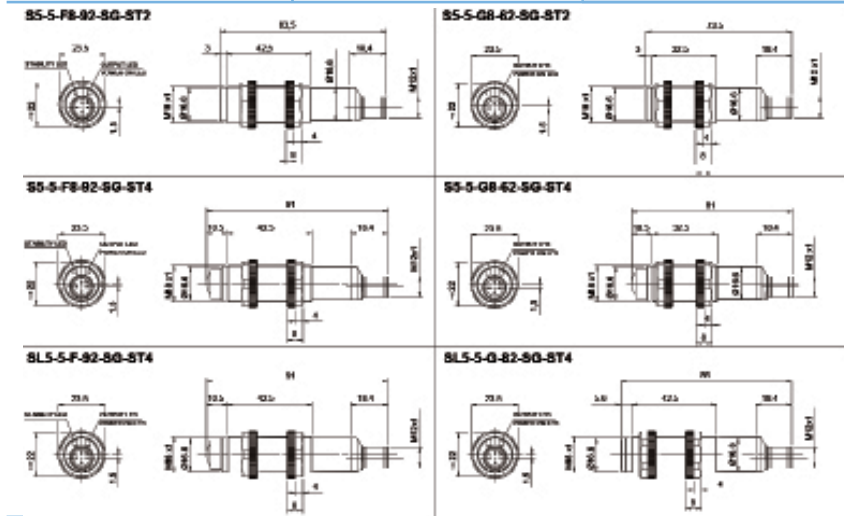

**OUTPUT:**

Emitter Type 2	S5-5-G8-62-SG-ST2		S300-PR-5-G00-EX-SG-ST2	
Receiver Type 2	S5-5-F8-92-SG-ST2		S300-PR-5-F00-OC-SG-ST2	
Emitter Type 4	S5-5-G8-62-SG-ST4			S300-PR-5-G00-EX-SG-ST4
Receiver Type 4	S5-5-F8-92-SG-ST4			S300-PR-5-F00-OC-SG-ST4
Laser Emitter Type 4		SL5-5-G-82-SG-ST4		
Laser Receiver Type 4		SL5-5-F-92-SG-ST4		

*For sensor cable and accessories see pages 53-56*

**\*CLASS 1 EN60825-1 (1994) LASER PRODUCT**  
NOTE: THE SAFETY PHOTOCELLS LISTED ABOVE ARE CERTIFIED AND MUST BE USED ONLY WITH SAFETY CONTROL UNITS SG-BWS-T4 AND SG-BWS-T4-MT SERIES. NEITHER TECHNICAL AND FUNCTIONING COMPATIBILITY NOR CERTIFICATIONS ARE GUARANTEED IF USING THEM WITH OTHER BRAND CONTROL UNITS OR OLD/OBSOLETE DATALOGIC AUTOMATION CONTROL UNITS

**Wiring Diagrams**

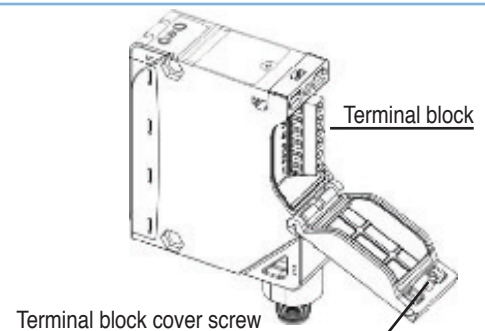
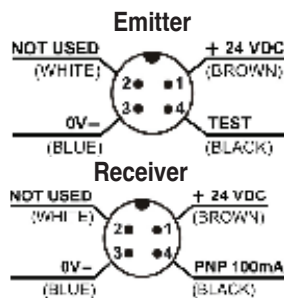

# ACCESSORIES FOR SAFETY LIGHT CURTAINS

## Brackets - Metal angled brackets

Code	Description
ST-KSTD	Fixing brackets (4pcs kit)
ST-K4OR	Orientable supports (4pcs kit)
ST-K6OR	Orientable supports (6pcs kit)
ST-K4AV	Anti-vibration supports (4pcs kit)
ST-K6AV	Anti-vibration supports (6pcs kit)

Compatible with **SG2/4 BASE, SG2/4 EXTENDED, SG2/4 COMPACT BODY, SG2 MUTING, SG2/4 BODY BIG, SG4 BODY REFLECTOR & SG4 LONG RANGE BASE**

## Brackets - Cascade brackets

Code	Description
ST-KCASCADSE-SG EXTENDED	Connection Bracket for SG4 EXTENDED Cascade

Compatible with **SG4 EXTENDED**

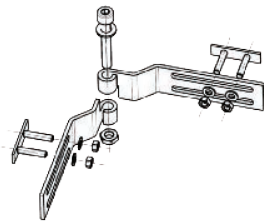

## Brackets - Rear brackets

Code	Description
ST-K4REAR-SG BODY BIG	Metal rear bracket mounting kit (4 brackets)

Compatible with **SG BODY BIG, SG BODY REFLECTOR & SG4 LONG RANGE BASE**

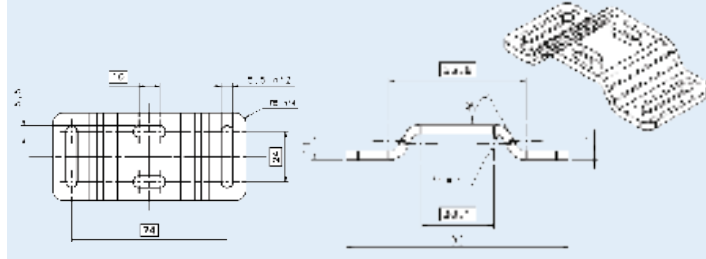

## Brackets - Rotating brackets

Code	Description
ST-K4ROT-SG BODY BIG	Metal top-bottom rotating fixing bracket mounting kit (4 brackets)
ST-K4ROT-SG BODY COMPACT	Metal top-bottom rotating bracket mounting kit (4 brackets)
ST-K4ROT	Metal top-bottom rotating brackets kit (4 brackets)

ST-K4ROT-SG-BODY BIG compatible with: **SG BODY BIG, SG BODY REFLECTOR & SG4 LONG RANGE BASE**

ST-K4ROT-SG-BODY COMPACT compatible with: **SG BODY COMPACT**

ST-K4ROT compatible with: **SG2/4 BASE & SG2 EXTENDED**

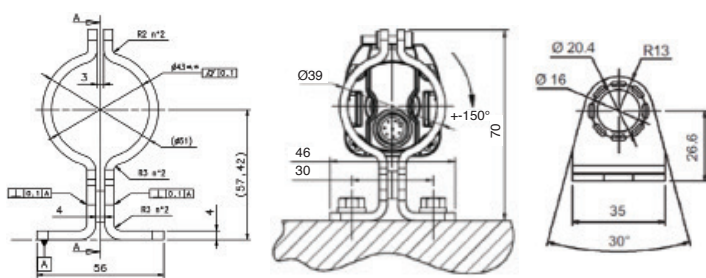

ST-K4ROT-SG BODY BIG

ST-K4ROT-SG BODY COMPACT

ST-K4ROT

## SG-IP69K - Protective Tubes

Code	Description
SG-IP69K150	Tubular IP69K H=150mm
SG-IP69K300	Tubular IP69K H=300mm
SG-IP69K450	Tubular IP69K H=450mm
SG-IP69K600	Tubular IP69K H=600mm
SG-IP69K750	Tubular IP69K H=750mm
SG-IP69K900	Tubular IP69K H=900mm
SG-IP69K1050	Tubular IP69K H=1050mm
SG-IP69K1200*	Tubular IP69K H=1200mm

Compatible with **SG2/4 BASE & SG2 EXTENDED**

SG-IP69K-2-050	Tubular IP69K H=500mm
SG-IP69K-3-080	Tubular IP69K H=800mm
SG-IP69K-4-090	Tubular IP69K H=900mm
SG-IP69K-4-120	Tubular IP69K H=1200mm

Compatible with **SG BODY COMPACT**

Note: 1) Each package contains the necessary to protect a single unit (emitter or receiver). To protect both elements of a couple, order two pieces  
2) Tubular PMMA POLICRIL material chemical resistance table is available on product's datasheet. \*Units with longer heights available on request.



## Lens Shield

Code	Description
SG-LS 150	Lens shield 150 mm
SG-LS 300	Lens shield 300 mm
SG-LS 450	Lens shield 450 mm
SG-LS 600	Lens shield 600 mm
SG-LS 750	Lens shield 750 mm
SG-LS 900	Lens shield 900 mm
SG-LS 1050	Lens shield 1050 mm
SG-LS 1200*	Lens shield 1200 mm
SG-LS 2	Lens shield 2 beans 500 mm
SG-LS 3	Lens shield 3 beams 800 mm
SG-LS 4-900	Lens shield 4 beams 900 mm
SG-LS 4-1200	Lens shield 4 beams 1200 mm
SG-LS-MC4	Elastic fastener for lens shield (kit 4pcs.)

SG-LSxxxx compatible with **SG2/4 BASE & SG2 EXTENDED**

SG-LS 2/3, SG-LS 4-900/120 compatible with **SG BODY COMPACT**

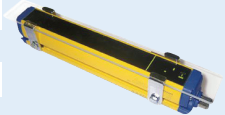

## Laser Pointer

Code	Description
SG-LP	SG-LP Laser pointer

Compatible with all **SG Series Safety Light Curtains**



## Communication Interface for Programmable Safety Light Curtains Dongle

Code	Description
SG4-DONGLE	Ethernet adaptor

Compatible with **SG4 EXTENDED**

## Functions

- Ethernet connection (TCP/IP) to Monitoring and Configuration Software SG4-E GUI.
- Configuration cloning
- Error logging
- Configuration logging

Note: To connect **SG-DONGLE** directly to a PC, order Ethernet cable

## CAB-ETH-M01

## Dongle - PC Ethernet Cable

Code	Description
CAB-ETH-M01	M12-IP67 Ethernet CAB 1M



## ACCESSORIES FOR SAFETY LIGHT CURTAINS

### Stands

**Stands** - Stands with adjustable mirrors (**SG-PSM**)

Code	Description
<b>SG-PSM-2-500</b>	Protective stand with 2 mirrors H=500 mm
<b>SG-PSM-3-800</b>	Protective stand with 3 mirrors H=800 mm
<b>SG-PSM-4-900</b>	Protective stand with 4 mirrors H=900 mm
<b>SG-PSM-4-1200</b>	Protective stand with 4 mirrors H=1200 mm



**Protective Stands** - (**SG-PSB**) and accessories

Code	Description
<b>SG-PSB 600</b>	Protective Stand H=600 mm
<b>SG-PSB 1000</b>	Protective Stand H=1000 mm
<b>SG-PSB 1200*</b>	Protective Stand H=1200 mm

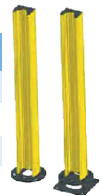

Compatible with all **SG Series Light Curtains SG-DM-Mirrors**

**Protective Stands** - (**SE-S**) and accessories

Code	Description
<b>SE-S 800</b>	Column and floor stand H = 800 mm
<b>SE-S 1000</b>	Column and floor stand H = 1000 mm
<b>SE-S 1200*</b>	Column and floor stand H = 1200 mm

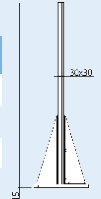

Compatible with all **SG Series Light Curtains SG-DM-Mirrors**

\*Units with longer heights available on request

### Stand Plate Kits

Code	Description
<b>SG-P</b>	Plate kit for protective stands

Compatible with protection stands **SG-PSB** mirror stands **SG-PSM**

Note: The kit includes two plates and three springs, to compensate the effect of collisions, vibrations and uneven floor surfaces.



**Mirrors** - Mirrors for finger and hand protection safety light curtains (**SG-DM**)

Code	Description
<b>SG-DM 600</b>	Deviating mirror version 600 mm
<b>SG-DM 900</b>	Deviating mirror version 900 mm
<b>SG-DM 1200*</b>	Deviating mirror version 1200 mm



Note: 1) To mount these mirrors into the stands **SG-PSB**, order **ST-PS-DM** mounting kit. 2) To mount these mirrors to columns **SE-S**, order two **ST-DM** mounting kits

\*Units with longer heights available on request

### Single Beam Mirrors

Code	Description
<b>SG-DM 150</b>	Deviating mirror version 150 mm

Note: 1) To mount this mirror into the stands **SG-PSB** order **ST-PS-DM** mounting kit. 2) To mount this mirrors to columns **SE-S**, order **ST-DM** mounting kit

### Mounting Kits for Mirrors

**Mounting Kits** - for **SG-DM** mirrors on **SE-S** floor columns

Code	Description
<b>ST-DM</b>	Kit stand alone

Compatible with **SG-DM** mirrors on **SE-S** floor columns

Note: For **SG-DM 150** stand-alone mirror, order one kit. For longer mirrors (**SG-DM 600** to **SG-DM 1900**), order two kits.

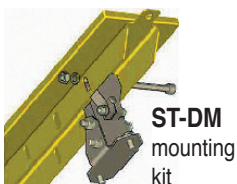

For standalone mirror (**SG-DM 150**) order one kit. For longer mirrors (**SG-DM 600** to **SG-DM 1900**), order two kits. The kit can be used to mount mirrors on **SE-S** column.

**Mounting Kits** - for **SG-DM** Mirrors, **SG-PSB** protective stands and safety light curtains

Code	Description
<b>ST-PS-DM</b>	Deviating mirror mounting kit (contains 2 T-nuts)

Compatible with **SG-DM** Mirrors in **SG-PSB** protective stands.

Note: For each mirror (**SG-DM xxx**) order 1 kit.

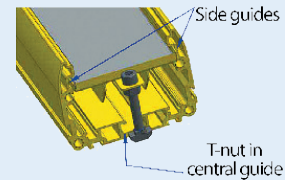

### Mounting Kits for Safety Light Curtains

Code	Description
<b>ST-PS4-SG BODY</b>	Protective stand mounting kit for SG BODY BIG (4 brackets)
<b>ST-PS6-SG BODY</b>	Protective stand mounting kit for SG BODY BIG (6 brackets)
<b>ST-PS4-SG</b>	Protective stands mounting kit for SG (4 brackets)
<b>ST-PS6-SG</b>	Protective stands mounting kit for SG (6 brackets)

**ST-PSx-SG** compatible with **SG2/4 BASE**, **SG2/4 EXTENDED**, **SG2 MUTING**, **SG BODY COMPACT**

**ST-PSx-SG BODY** compatible with **SG BODY BIG**, **SG BODY REFLECTOR**

Note: 1) Each kit allows to install an element (emitter or receiver, active part or passive part) of a light curtain. To install both elements of the light curtain, order 2 kits of the same type. 2) For light curtains with height  $\geq 1200$  mm, order the 6 brackets kits (**ST-PS6-SG xxx**).

### Accessories for Muting

#### Muting Arms

Active/Passive Arms

Code	Description
<b>SG-L-ARMS</b>	Active/Passive arms Couple for L muting
<b>SG-T-ARMS</b>	Active/Passive arms Couple for T muting
<b>SG-AS-ARM</b>	Active sensor single arm
<b>SG-PR-ARM</b>	Passive reflector single arm

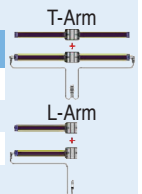

#### Emitter/Receiver Arms

<b>SG-F1-G1-ARMS</b>	Emitter/Receiver arms couple (first couple)
<b>SG-F2-G2-ARMS</b>	Emitter/Receiver arms couple (second couple)

#### Brackets and Cables

Code	Description
<b>SG-CB-B</b>	Muting arms mounting bracket kit for BIG series
<b>SG-CB-C</b>	Muting arms mounting bracket kit for COMPACT series
<b>CV-Y1-02-B-007</b>	M12 4-Pole T muting cable
<b>CV-L1-02-B-007</b>	M12 4-Pole L muting cable

#### Compatibility and Operating Distances

Muting Arm Code	Light Curtain Code	Operating Distance
<b>SG-L-ARMS</b> <b>SG-T-ARMS</b> <b>SG-AS-ARM</b> <b>SG-PR-ARM</b>	<b>SG BODY COMPACT MUTING</b> <b>SG2 BODY BIG MUTING</b> <b>SG4 BODY BIG MUTING SHORT RANGE*</b> <b>SG BODY COMPACT MUTING</b> <b>SG BODY REFLECTOR MUTING</b>	0.5-3m
<b>SG-F1-G1-ARMS</b> <b>SG-F2-G2-ARMS</b>	<b>SG2 BODY BIG MUTING</b> <b>SG4 BODY BIG MUTING SHORT RANGE*</b> <b>SG BODY COMPACT MUTING</b>	0.5-7m

\* **SG4 BODY MUTING LONG RANGE** (whose operating range is 6-60m) can not be used in combination with muting arms.

Note: **SG-T-ARMS** (T muting cable **CV-Y1-02-B-007** is included)

**SG-L-ARMS** (L muting cable **CV-L1-02-B-007** is included)



# CONTROL UNITS, SAFETY RELAYS & CONNECTOR BOXES

- Integrated control of 4 single beams and 2 light curtains
- Simple DIP Switch configuration
- Muting functions can be assigned to light curtains or single beams



Code	SG-BWS-T4	SG-BWS-T4-MT
<b>Inputs</b>		
Power Supply	24VDC - 15/+10%	24VDC - 15/+10%
PNP Outputs from S5/SL5/S300	4	4
OSSDs Couples from SLC	-	2
Muting Inputs	-	4
Test, Reset, Override, EDM, Muting enable, Auto/Man Selector	3	9
Safety Outputs	2PNP	2NO
Muting Lamps	-	2
<b>Outputs</b>		
Test Outputs	4	4
Response Time	29ms	39ms
<b>Mechanical Data</b>		
Operating Temp.	0 to 55°C	0 to 55°C
Mechanical Protection	IP20	IP20
<b>Functions</b>		
Functions*	Automatic/Manual Reset, External Device Monitoring	Automatic/Manual Reset, External Device Monitoring L/T Muting, Double Muting, Muting Enable, Muting Timeout, Override
Compatibility Single Beam Photocells	S5/SL5/S300	S5/SL5/S300
Compatibility Safety Light Curtains	-	All Datalogic Safety Light Curtains

Function settings are done through DIP switches in the SG-BWS-T4-MT and through wiring in the SG-BWS-T4

SE-SR2 is a safety unit that can be used in combination with every DATALOGIC Safety Light Curtains. It provides dual-channel operation without detection of shorts across contacts. Short circuits and earth faults in the pushbutton circuit are detected. CS-ME is an interface with two forcibly guided relays, providing 3 NO contacts. The diagnostic function must be performed by the Safety Light Curtains through External Device Monitoring function.



Code	SE-SR2	CS-ME
Power Supply	24VDC-15/+10%	24VDC-/+20%
Safe Outputs (Cat.4)	3NO	3NO
Auxiliary Outputs	1NC	1NC
Response Time Following Input going Off	typ. 10ms, max. 20ms	15ms
Response Time With Power Failure	typ. 70ms, max. 120ms	15ms
Recovery Time Following Inputs going On	50ms	40ms
Recovery Time After Power On	150ms	40ms
Operating Temperature	-10 to 55°C	-25 to 55°C
Mechanical Protection	IP20	IP20

<b>Functions</b>		
Reset Modes	Automatic/Manual/Monitored	Automatic
External Device Monitoring	Available on SE-SR2	Must be activated on Safety Light Curtain (ESPE)
Compatibility	All Datalogic Safety Light Curtains	All Datalogic Safety Light Curtains with EDM function

SG-SRT1 and SG-SRT2 are interfaces provided with redundant forcibly guided relays, supplying a ready operator interface to restart or override the Safety Light Curtain, and have muting indication. SG-SRT1 and SG-SRT2 provide internal or external EDM signal to the Safety Light Curtain: to operate safely, EDM monitoring function must be activated on the Safety Light Curtain and correct wiring must be followed.



Code	SG-SRT1	SG-SRT2
Power Supply	24VDC +/-20%	24VDC +/-20%
Safe Outputs	2NO	2NO
Max. Switchable Voltage	250VAC	250VAC
Max. Switchable Current	2A	2A

<b>Functions</b>		
Reset Mode	Automatic/Manual, Test, Reset, Restart, Override	Automatic/Manual, Test, Reset, Restart, Override Muting State Indication
Compatibility	SG BODY COMPACT MUTING SG BODY BIG MUTING SG BODY REFLECTOR MUTING	SG BODY BIG MUTING SG BODY REFLECTOR MUTING

**NEW**

**MOBILE SCANNERS & VEHICLE MOUNT COMPUTERS**

*For more information on a solution using these products, please contact our Automation Specialists*



Range	91XX RANGE	93XX RANGE	95XX RANGE
Description	The PowerScan 91XX linear imagers introduce a new green scanning line for outstanding 1D data collection. Available in Desk, Bluetooth® and Mobile (STAR radio) versions.	The PowerScan 93XX laser readers offer state-of-the-art performance in an industrial product. Available in Desk, Bluetooth® and Mobile (STAR radio) versions.	The PowerScan 95XX area imagers include omnidirectional reading with outstanding optical characteristics. Available in Desk, Bluetooth®, Mobile (STAR radio) and DPM versions.

**Applications**

Retail	✓	✓	✓
Manufacturing	✓	✓	✓
Transport & Logistics	✓	✓	✓

*For more information on a solution using these products, please contact our Automation Specialists*



Range	DL-AXIST	FALCON-X4	SKORPIO X4
Description	Rugged full touch Enterprise Class PDA with Android technology and a brilliant 5" screen. It is equipped with an advanced 2D imager allowing quick and easy data capture from high density codes.	Rugged ergonomics combine in a fully featured mobile computer to provide the ultimate performance in Warehousing and T&L. 1D laser and 2D imaging technologies available.	A high performance multicore 1 Ghz architecture that offers blazing speed when running WEC7 or Android

**Applications**

Retail	✓	✓	✓
Manufacturing	✓	✓	✓
Transport & Logistics	✓	✓	✓

*For more information on a solution using these products, please contact our Automation Specialists*



Range	RHINO II	BLACKLINE SH15	BLACKLINE SH21
Description	Vehicle mount computers available in 10" and 12" display sizes; sets the standard for ruggedness in the warehouse. Choices of WEC, WES7, Windows 10 IoT Enterprise or Android 7.1 operating systems.	A 15" Vehicle mount computer as well as a fixed mount unit for use in any industrial application. It increases productivity through reduced errors during all scanning activities	A 21" Industrial computer designed for wall or fixed mount industrial applications. It increases productivity by allowing a high level of interaction between operators and machines

**Applications**

Retail	✓	✗	✗
Manufacturing	✓	✓	✓
Transport & Logistics	✓	✓	✓

**NEW** TIME OF FLIGHT SAFETY LASER SENTINEL™ WITH 275° OPENING ANGLE IP65 (EN60529)

Type 3 Arm and Body	Basic 3 Zone Sets	Standalone 6 Zone Sets	Master 10 Zone Sets	Slave (remote)
<ul style="list-style-type: none"> <li>Type (EN61496-1)</li> <li>PL (EN ISO 13849-1)</li> <li>SIL (IEC 61508)</li> </ul>				
Detection Capability	70mm	40/70mm Selectable	40/70mm Selectable	40/70mm Selectable
Safety zone op range	0.05 - 5.5m	0.05 - 5.5m	0.05 - 5.5m	0.05 - 5.5m
Warning Zone Max	0.05 - 40m	0.05 - 40m	0.05 - 40m	0.05 - 40m
Max Simultaneous Warning Zones	1	2	2	2
Power Supply	24VDC	24VDC	24VDC	24VDC
Response Time	Min: 62ms; Max: 482ms	Min: 62ms; Max: 482ms	Min: 62ms; Max: 482ms	Min: 62ms; Max: 482ms
Output Current	250mA max/each OSSD	250mA max/each OSSD	250mA max/each OSSD	-
Input Load Current	15mA	15mA	15mA	-
Connection	M12 8 pole	M12 8 pole	M12 8 pole & M12 12 pole	-
<b>Applications</b>				
Horizontal Static	Yes	Yes	Yes	Yes
Vertical Static	No	Yes	Yes	Yes
Moving (Simple AGV's)	No	Yes	Yes	Yes
Moving (Medium AGV's)	No	No	Yes	Yes
Codes	<b>SLS-B5</b>	<b>SLS-SA5-08</b>	<b>SLS-M5-0812</b>	<b>SLS-R5</b>

ETHERNET TO HOST CABLES are used for programming and monitoring the device with DL Sentinel, and for reading the measurement data. CABLES TO REMOTE are used to connect the Master models to the Slaves

**Cables**

Code	Description
<b>CS-A1-06-U-03*</b>	8 Pole Cable 3m
<b>CS-A1-10-U-03*</b>	12 Pole Cable 3m
<b>CAB-ETH-M01**</b>	4 Pole M12 IP67 Ethernet to Host Cable 1m
<b>SLS-CABLE-R-5^</b>	8 Pole Cable to Remote units

\* For 5m or 10m Cable lengths replace 03 with 05 or 10 e.g. **CS-A1-06-U-05**

\*\*For 5m or 10m Cable lengths replace 01 with 05 or 10 e.g. **CAB-ETH-M10**

^ For 10m or 20m Cable lengths replace 5 with 10 or 20 e.g. **SLS-CABLE-R-10**

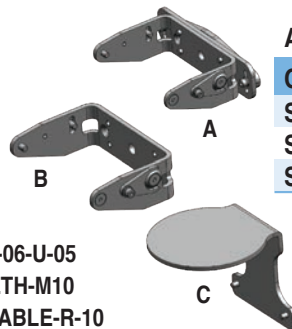

**Accessories**

Code	Description
<b>SLS-BRACKET-A</b>	Complete Bracket System
<b>SLS-BRACKET-B</b>	Pitch Regulation Bracket System
<b>SLS-BRACKET-C</b>	Head Protective Bracket



## NEW PRESSURE TRANSMITTERS 4-20MA OUTPUT IP67

Type TPS30 Series	Head	DIN43650-A	M12	Cable
For use with Air, Non-corrosive gas and fluid that will not corrode S/S 316L				
Code: Gauge Pressure	TPS30-G1*A**-00	TPS30-G2*A**-00	TPS30-G3*A**-00	TPS30-G5*A**-00
Code: Sealed Gauge Pressure	TPS30-G1^A**-00	TPS30-G2^A**-00	TPS30-G3^A**-00	TPS30-G5^A**-00
Code: Absolute Pressure	TPS30-A1*A**-00	TPS30-A2*A**-00	TPS30-A3*A**-00	TPS30-A5*A**-00

## NEW MULTI CHANNEL PRESSURE SENSOR INDICATORS 4-20MA INPUT IP65

Code	Display Pressure Units	Input Channels	Power Supply	Current Consumption
PNP NO <b>PSM4-APD</b>	Standard Pressure: MPa, kPa, kgf/cm, Bar, psi Negative & Compound Pressure: kPa, kgf/cm, Bar, psi, mmHg, inHg, mmHO	4	12-24VDC	100mA Max
NPN NO <b>PSM4-AD</b>		4		
PNP NO <b>PSM8-APD</b>		8		
NPN NO <b>PSM8-AD</b>		8		

## NEW FLUID & PNEUMATIC DIGITAL PRESSURE SENSOR IP40

Code	Standard Pressure	Standard Pressure	Negative	Compound
PNP NO	PSAN-*01CPA-1/8^	PSAN-*1CPA-1/8^	PSAN-*V01CPA-1/8^	PSAN-*V01CPA-1/8^
NPN NO	PSAN-*01CA-1/8^	PSAN-*1CA-1/8^	PSAN-*V01CA-1/8^	PSAN-*V01CA-1/8^
4-20mA	PSS-01A-R1/8	PSS-1A-R1/8	PSS-V01A-R1/8	PSS-V01A-R1/8
Rated Pressure Range	0.0 - 100.0kPa (0-1Bar)	0.0 - 1000.0kPa (0-1Bar)	0.0 to -101.3kPa (0.0 to -1.013Bar)	0.0 to -101.3kPa (0.0 to -1.013Bar)

\* For Bottom fitting pressure port add L to part number e.g. PSAN-L01CA-R1/8  
 ^ For units with NPT1/8 pressure port change R1/8 to NPT1/8 e.g. PSAN-L01CA-NPT1/8

- Specifications**
- Power Supply: 12-24VDC
  - Current Consumption: 75mA Max
  - Analog Output: 4-20mA PSAN
  - Connection: 2m Cable
  - Display Units: MPa, kPa,kgf/cm, bar, psi, mmHg, inHG, mmH2O

## NEW DUAL LCD DISPLAY DIGITAL PRESSURE SENSORS

Power Supply: 12-24VDC

Code	Rated Pressure Range	Display Pressure Units	Pressure Port	Current Consumption	IP Rating
PNP NO or NPN NO <b>PSQ-01C*-RC1/8</b>	-100.0 to 100.0kPa (-1 to 1 bar)	MPa, kPa, kgf/cm, Bar, psi, mmHg, inHg, mmHO	RC1/8	Consumption = 50mA Max. Output = 70mA Max	<b>IP40</b>
PNP NO or NPN NO <b>PSQ-C1C*-RC1/8</b>	-100.0 to 1,000kPa (-1 to 10 bar)		RC1/8		<b>IP40</b>
PNP NO or NPN NO <b>PSQ-BC01*-R1/8</b>	-100.0 to 100.0kPa (-1 to 1 bar)		R1/8		<b>IP65</b>
PNP NO or NPN NO <b>PSQ-BC1*-R1/8</b>	-100.0 to 1,000kPa (-1 to 10 bar)		R1/8		<b>IP65</b>

\* For units with Selectable Voltage (1-5VDC) Current (4-20mA) Output & AUTO SHIFT, REMOTE ZERO, HOLD input add **U** to part number e.g. PSQ-BC1U-R1/8

### Gauge & Absolute Pressure

Code	Pressure Range	Code	Pressure Port
<b>3</b>	0-1 Bar	<b>G8</b>	G3/8 (PF)
<b>4</b>	0-2 Bar	<b>G4</b>	G1/4 (PF)
<b>5</b>	0-7 Bar	<b>R2</b>	R1/2 (PT)
<b>6</b>	0-10 Bar	<b>N4</b>	NPT 1/4
<b>7</b>	0-20 Bar		
<b>8</b>	0-35 Bar	<b>G4</b>	G1/4 (PF)
<b>9</b>	0-50 Bar	<b>N4</b>	NPT 1/4
<b>A</b>	0-100 Bar		
<b>B</b>	0-200 Bar		
<b>C</b>	0-400 Bar		
<b>D</b>	0-500 Bar		
<b>E</b>	0-600 Bar		

### Sealed Gauge Pressure

Code	Pressure Range	Code	Pressure Port
<b>F</b>	-1-0 Bar	<b>G8</b>	G3/8 (PF)
<b>G</b>	-1-1 Bar	<b>G4</b>	G1/4 (PF)
<b>H</b>	-1-7 Bar	<b>R2</b>	R1/2 (PT)
<b>J</b>	-1-10 Bar	<b>N4</b>	NPT 1/4
<b>K</b>	-1-20 Bar		

Note: for Gauge Pressure 8,9,A,B,C,D,E only available in G4 & N4  
 Note: for Absolute Pressure only available in 3,4,5,6,7

# AREA SENSORS / LIGHT GRIDS

NEW

Type DC Areascan TM Series	AS1		DS1		DS2	
					Serial RS485	Ethernet
<ul style="list-style-type: none"> <li>Nominal Voltage 24VDC</li> <li>Output PNP</li> <li>Output Current 100mA max</li> <li>Current Consumption TX 100mA Max</li> <li>Current Consumption RX 40mA Max</li> <li>Housing Material Black electro-painted aluminium</li> </ul>						
Sensing Area (Controlled Height)	100mm		100mm-300mm		150-1650mm	600-1650mm
Sensing Distance	2.1m	3m	2m	4m	0.3 - 10m	0.3 - 5mm
Output	PNP		PNP and Analog		PNP, 0-10V & RS485	PNP, 0-10V & Ethernet
Response Time	1,75ms. 2,75 - 8ms.		1-2, 75ms		5-90ms	
Resolution	Flat: 0,2 x 75mm. Cylindrical: @6mm		4mm-7mm		6mm(5m)/25mm(10m)	6mm
Connection	Rx: M12 5-Pole Tx: M12 4-Pole		Rx: M12 5-Pole Tx: M12 4-Pole		Rx: M12 8-Pole Tx: M12 4-Pole	
Dimensions (mm)	22 x 43 x 150		22 x 43 x (150-300)		35 x 40 x (256-1726)	

**Wiring Diagrams**

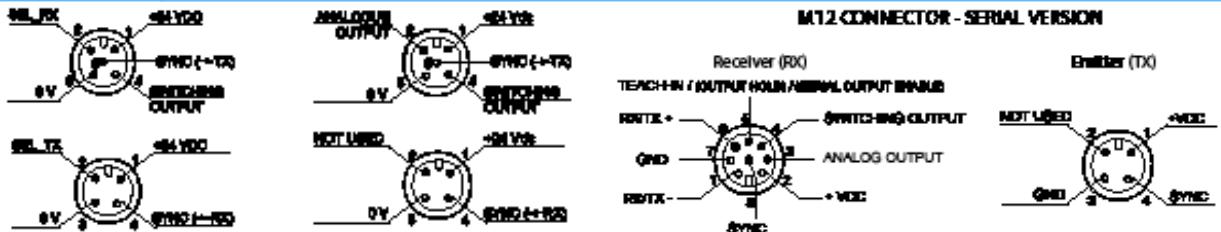

**OUTPUT:**

	AS1-LD-HR-010-J*	AS1-HD-HR-010-J	-	-	-	-
PNP High Resolution	AS1-LD-SR-010-J*	AS1-HD-SR-010-J	-	-	-	-
PNP Standard Resolution	-	-	DS1-LD-S**R-010-J^V	DS1-HD-SR-010-JV	-	-
100mm (7mm resolution)	-	-	DS1-LD-S**R-015-J^V	DS1-HD-SR-015-JV	DS2-05-07-015-JV	-
150mm (7mm resolution)	-	-	DS1-LD-SR-030-J^V	DS1-HD-SR-030-JV	DS2-05-07-030-JV	-
300mm (7mm resolution)	-	-	-	-	DS2-05-07^AA-045-JV	-
450mm	-	-	-	-	DS2-05-07^AA-060-JV	DS2-05-07-060-JE
600mm	-	-	-	-	DS2-05-07^AA-075-JV	DS2-05-07-075-JE
750mm	-	-	-	-	DS2-05-07^AA-090-JV	DS2-05-07-090-JE
900mm	-	-	-	-	DS2-05-07-105-JV	-
1050mm	-	-	-	-	DS2-05-07-120-JV	DS2-05-07-120-JE
1200mm	-	-	-	-	-	-

\* For units with trimmers replace J with P e.g. AS1-LD-HR-010-P \*\*For units with 4mm High resolution replace S with H e.g. DS1-HR-010-JV

^For units with adjustment trimmer replace J with P e.g. DS1-SR-010-PV (adjustment timmer only available in 7mm resolution units)

^^For units with 25mm resolution change 07 to 25 e.g. DS2-05-25-045-JV

## INDUSTRY 4.0 IO-LINK ASIC SMART SENSORS

Type IO Link S5N Series	Diffuse Proximity	Retroreflective		Background Suppression	Contrast
	Long Distance	Polarized	Transparents		
Current Consumption: 25mA Max Output Current: 100mA Max Supply Voltage: 10-30VDC Connection: M12 4-Pole					
Sensing Distance	700mm	400mm	1.3mm	150mm	10mm
Connectivity	IO-Link V1.1.2 Smart Sensor Profile Fully Programmable Double Output Stage through IO-Link Parametrization				

**OUTPUT:**

IO Link	S5N-P*A-5-C01-OZ	S5N-P*A-5-B01-OZ	S5N-PA-5-T01-OZ	S5N-P*A-5-M03-OZ	S5N-PA-5-W03-OZ
IO Link Laser	S5N-P*L-5-C01-OZ	S5N-P*L-5-B01-OZ	-	-	-





Type IO Link S100 Series	Retroreflective	Transparents	Background Suppression	Contrast
	Polarized			
Current Consumption: 30mA Max Output Current: 100mA Max Supply Voltage: 10-30VDC Connection: M8 4-Pole				
Sensing Distance	550mm	200mm	200mm	12.5mm ± 2mm
Connectivity	IO-Link V1.1.2 Smart Sensor Profile Fully Programmable Double Output Stage through IO-Link Parametrization			

**OUTPUT:**

IO Link	S100-PR-5-B10-OZ	S100-PR-5-T10-OZ	S100-PR-5-M10-OZ	S100-PR-5-W00-OZ
---------	------------------	------------------	------------------	------------------

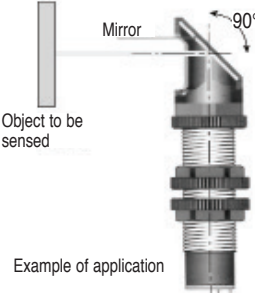
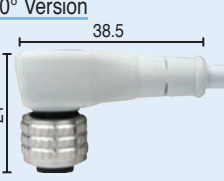
LIMIT & PRESSURE SWITCHES & SENSORS

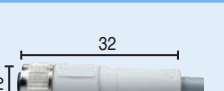
# CABLE & ACCESSORIES FOR PROXIMITY SWITCHES & SENSORS

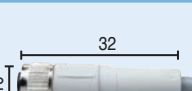
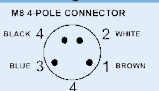
Dimensions			Cable Length*		Code	Accessories for 90° Sensing		
						Code	DEV90	90° Adaptor
Female connector and cable M12 Plug						For use with M18 photo electric sensors		
90° Version			4 Pin 4 Wire	3m	<b>CS-A2-02-G-03</b>		35	
				5m	<b>CS-A2-02-G-05</b>			
Straight Version			3 Pin 3 Wire	5m	<b>CS-A2-11-G-05</b>	Example of application		
				Connector with no cable	<b>CS-A2-02-B-NC</b>			
			4 Pin 4 Wire	3m	<b>CS-A1-02-G-03</b>	Nuts		
				5m	<b>CS-A1-02-G-05</b>			
			3 Pin 3 Wire	3m	<b>CS-A1-01-G-03</b>			
				5m	<b>CS-A1-01-G-05</b>			
Female connector and cable M8 Plug						*For Plastic Type, add <b>P</b> to code		
			4 Pin 4 Wire	3m	<b>CS-B1-02-G-03</b>			
				5m	<b>CS-B1-02-G-05</b>			
			3 Pin 3 Wire	3m	<b>CS-B1-01-G-03</b>			
				5m	<b>CS-B1-01-G-05</b>			

## Reflectors

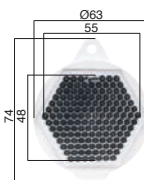
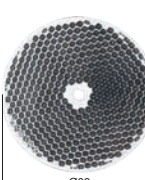
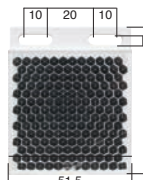
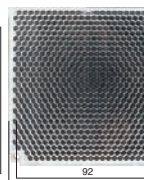
R2	R5	R4	DAC100
			

## Shutter for Emitter-Receiver Thru Beam

Accessory to sense small size object with emitter-receiver cylindrical barriers M18.

Code	P180TT	Shutter kit
		
<b>Note:</b> Each package contains three shutter disks.		
Shutting Diam.	Min. Object to be Sensed	Distance Attenuation
⊙ 2mm	≥ 2mm	97%
⊙ 4mm	≥ 4mm	84%
⊙ 8mm	≥ 8mm	54%

**Note:** The datum "Minimum object to be sensed" refers to the condition of shutter mounted on emitter/receiver.

## Reflector Tape







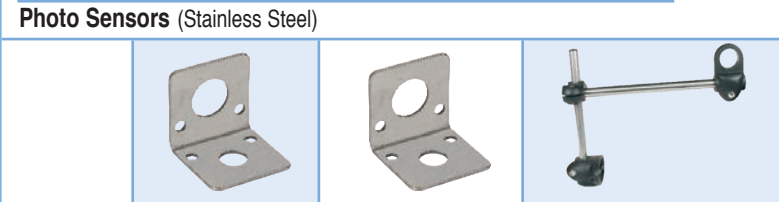

MST-50	MST-100-5	MST-200-2
50 x 50mm	100 x 100mm	200 x 200mm

## Mounting Brackets for M12, M18 & M30 Proximity Switches and Photo Sensors (Stainless Steel)

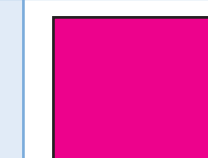

Code	ST1218	ST1830	JOINT-18
Description	For M12 & M18	For M18 & M30	Adjustable M18 Mounting Bracket

# NEW IO-Link MASTER 20-30VDC WITH CABLES ACCESSORIES IP67

IO-Link	EtherNet/IP™, Modbus/TCP (slave)	PROFINET IO, Modbus/TCP (slave)	M12 L-Coded Axial	M12 5-Pole 3m Double Headed Axial Cables	M8 4-Pole to M12 5-Pole 3m Double Headed Axial Cables
					
Code	CBX-8IOL-EIP	CBX-8IOL-PNIO	CS-M1-02-B-03	CS-H1-02-B-03	CS-I1-02-B-03

- Eight M12 IO-Link ports to PROFINET or Ethernet IP, which allows up to eight sensor or actuator connections on a single master
- Dual Ethernet ports
- Additional digital input on every port
- Power port sharing capability
- PLC access to IO-Link ISDU blocks without complex programming
- Supports the IOL\_CALL function
- OPC-UA based technology
- Web server

Please Note: For IO link sensors please see **S5N** and **S100** range on page ?? & ??



# SENSOR CABLES & CONNECTORS

## M8 Series

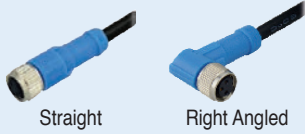

### M8 PIN Assignment

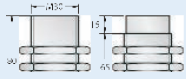

### M12 PIN Assignment

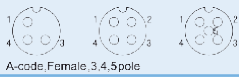

## M12 Series



PIN	Wire Colour		
	3-Pole	4-Pole	5-Pole
1	Brown	Brown	Brown
2		White	White
3	Blue	Blue	Blue
4	Black	Black	Black
5			Grey

Poles	Angle	Cable Type	M8 Female Code	M12 Female Code
3-Pole	Straight	Non-Shielded	M8FS-3V*-3**	M12FS-3V*-3**
4-Pole	Straight	Non-Shielded	M8FS-4V*-3**	M12FS-4V*-3**
5-Pole	Straight	Non-Shielded		M12FS-5V*-3**
3-Pole	Straight	Shielded	M8FS-3V*-3**SH	M12FS-3V*-3**SH
4-Pole	Straight	Shielded	M8FS-4V*-3**SH	M12FS-4V*-3**SH
5-Pole	Straight	Shielded		M12FS-5V*-3**SH
3-Pole	Right Angled	Non-Shielded	M8FR-3V*-3**	M12FR-3V*-3**
4-Pole	Right Angled	Non-Shielded	M8FR-4V*-3**	M12FR-4V*-3**
5-Pole	Right Angled	Non-Shielded		M12FR-5V*-3**
3-Pole	Right Angled	Shielded		M12FR-3V*-3**SH
4-Pole	Right Angled	Shielded		M12FR-4V*-3**SH
5-Pole	Right Angled	Shielded		M12FR-5V*-3**SH

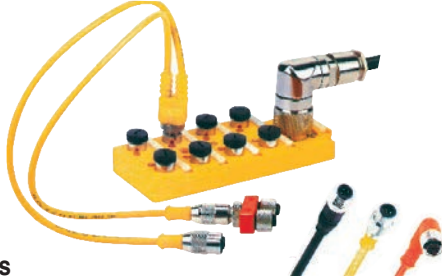

## M23 Female Connectors for Plug Type Distribution Boxes

Code	Description
Z-FS12KAT5005	M23 12P Plug & 5m Cable

## M12 Male to Female Cable Connectors

Code	Description
R-MS5TZU822+R-FS5TZU822	M12 5P Male to Female - Straight
R-MS5TZU822+R-FA5TZU822	M12 5P Male to Female - Right Angle

## Micro Splitters with Cable - M12 Splitter with 2 x M12 plugs

Code	Description
U2-R4R-FS4KPV062	Male to Female Straight (PNP)
U2-R4R-FS4KZV062	Male to Female Straight
U2-R4R-FA4KPV062	Male to Female Right Angle (PNP)
U2-R4R-FA4KZV062	Male to Female Right Angle

## Micro Splitters

Code	Description
U2-R5/4Z-R4	M12 5P Male - M12 4P Female
U2-R5/5Z-R5	M12 5P Male - M12 5P Female

## M8 NPN Sensor Actuator Boxes Single or Double Occupancy. Cable or M23 Plug Versions with LED's IP67

Poles	Cable Length	Ports	Code
3/4-Pole	5m	4	M8PSL-3†4P-5U^^
3/4-Pole	10m	4	M8PSL-3†4P-10U
3/4-Pole	5m	6	M8PSL-3†6P-5U^^
3/4-Pole	10m	6	M8PSL-3†6P-10U
3/4-Pole	5m	8	M8PSL-3†8P-5U^^
3/4-Pole	10m	8	M8PSL-3†8P-10U
3/4-Pole	5m	10	M8PSL-3†10P-5U^^
3/4-Pole	10m	10	M8PSL-3†10P-10U

\* For PUR version cables replace V with U e.g. M8FS-3U-3  
 \*\* For 1.5m, 5m or 10m Cable lengths replace 3 with 1.5, 5 or 10 e.g. M8F3-3V-5

^^ For M23 plug types replace U with M23 e.g. M8PSL-34P-M23

†For Double Occupancy Boxes, replace PSL-3 with PDL-4 e.g. M8PDL-44P-5U^^

Note: 4-Pole units are Double Occupancy Boxes

## M12 NPN/NPN Sensor Actuator Boxes Single or Double Occupancy. Cable or M23 Plug Versions with LED's IP67

Poles	Cable Length	Ports	Code
5-Pole	5m	4	M12P†SL-54P-5U^^
5-Pole	10m	4	M12P†SL-54P-10U
5-Pole	5m	6	M12P†SL-56P-5U^^
5-Pole	10m	6	M12P†SL-56P-10U
5-Pole	5m	8	M12P†SL-58P-5U^^
5-Pole	10m	8	M12P†SL-58P-10U

^^ For M23 plug types replace U with M23 e.g. M12PSL-54P-M23

For Double Occupancy Boxes, replace S with D e.g. M12PDL-54P-5U

†For NPN versions replace P with N e.g. M12NSL-54P-M23

## Distribution Boxes

Code	Description
Cable Type - 54 x 127mm	
DSTR8-5/4AZ-1205	5P 4 Wire 250VAC
DSTR8-5/4PA-1205	5P 4 Wire PNP 10-30VDC LED's
DSTR8-5/4NA-1205	5P 4 Wire NPN 10-30VDC LED's

## Plug Type

DLTR8-5/4NA-T12	5P 4 Wire NPN 10-30VDC LED's
DLTR8-5/4PA-T12	5P 4 Wire PNP 10-30VDC LED's
DM8C8-4/4PC-12705	M8 4P PNP 10-30VDC LED's

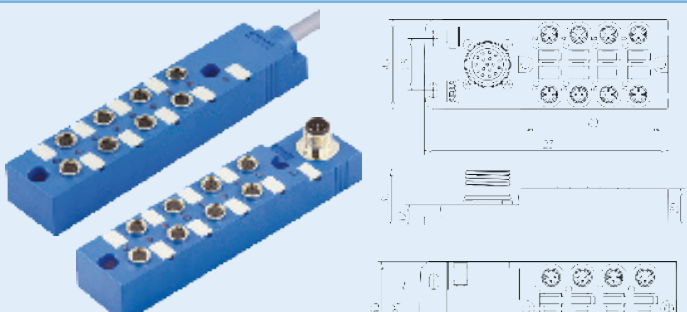

### Single Occupancy v Double Occupancy

Single Occupancy: Contains one signal  
 1...+24V, 3...0V, 4...I/O(A), 5...PE

Double Occupancy: Contains two signals  
 1...+24V, 2... I/O(B), 3...0V, 4...I/O(A), 5...PE

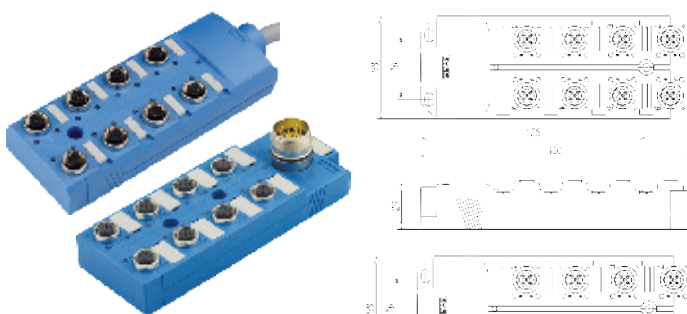

### Single Occupancy v Double Occupancy

Single Occupancy: Contains one signal  
 1...+24V, 3...0V, I/O(B), 5...PE

Double Occupancy: Contains two signals  
 1...+24V, 2...I/O(B), 3...0V, 4...I/O(A), 5...PE



# OPTICAL ROTARY ENCODER SPECIFICATIONS

## What is an encoder

Optical rotary encoders (or shaft encoders) are made to provide output signals or digital data based on physical mechanical measures:

- Rotational speed of the encoder shaft
  - Direction of rotation
  - Angular position of the shaft
  - Linear displacement (by end-drives or measuring wheels)
- Encoders are used as sensors for motion control, length measurement and positioning applications.



## How is made

The encoder shaft transfers its rotation to a coded disc made of lines which shadow the light from photo-emitters to photo-receivers, thus generating a variable electrical signal. According to the different coded disk mask and electrical circuit there are two types of encoders: incremental or absolute.

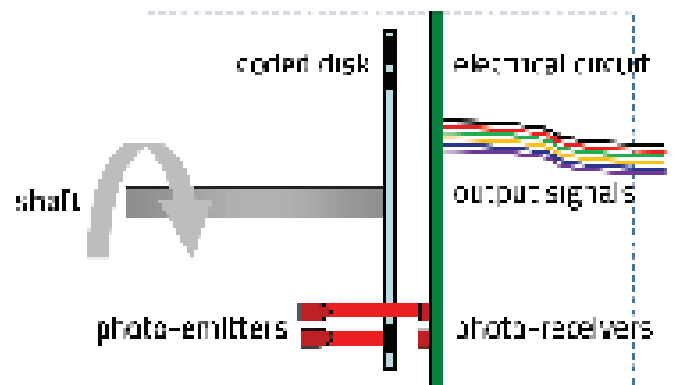

## Incremental encoders

Incremental encoders produce sinusoidal or square wave outputs, which give an incremental number of pulses per revolution of the shaft.

The resolution is defined as Pulse Per Revolution (PPR).

The signals start at the power up and the shaft position is not retained when encoder is switched-off, so they can be used to control rotation speed and direction, but can't know the absolute position. A 4-0 PPR phase shifted tracks and zero and  $\overline{A}/\overline{B}/\overline{Z}$  complement outputs are used to detect rotation direction, increase resolution and avoid false counts. The Z index is used as reference marker for the 'home' position. Datalogic incremental encoders offer a Smart Push Pull & Line Driver output which is suitable for both configurations.

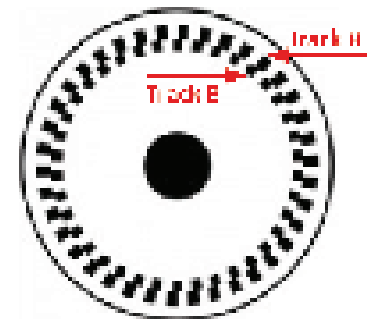

## Absolute encoders

Absolute encoders generate a multi-bit digital data information providing the actual angular position of the shaft. Single-turn absolute encoders repeat the code for every shaft revolution. Multi-turn absolute encoders increase the code at each shaft revolution. Shaft position is retained when the absolute encoder is switched-off, so it can provide the absolute position, as well as rotation speed or direction. Absolute encoders have a different bit mask for each angular position, resolution is defined as Code Per Revolution (CPR) and is also expressed in bits. The simple example shows a 4-bit mask, that's 16 CPR. Datalogic absolute encoders are available either with SSP<sup>®</sup> serial synchronous interface, or Fieldbus interfaces as CANopen<sup>®</sup>, DeviceNet, EtherCAT, Profibus, or Profinet.





# PHOTO SENSOR SPECIFICATIONS

## WORKING PRINCIPLES

A sensor is made up of an irradiating element, a particular type of light (usually infrared, red or green) and an element photosensitive to the irradiated light. The presence or absence of light on the photosensitive element is used as a signal producing a change in the output of the sensor. Thanks to the qualities of transmission and propagation of the light, different types of sensor can be used.

### Thru-beam

This type is made up of an emitter and a receiver on the same axis. Every time an object interrupts the light beam, which goes from the emitter to the receiver, a change in the receiver output takes place. This type allows great sensing distances and is particularly suitable for being used in dirty and dusty locations

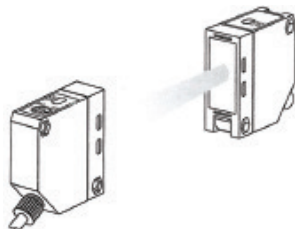

### Diffuse Reflective

In this case the light source and the photosensitive element are included in the same unit. The emitted light reaches the photosensitive element after being reflected from an object present in the irradiation field. The presence or absence of the light on the receiver causes a change in the output state signalling either the presence or absence of an object in the sensing area.

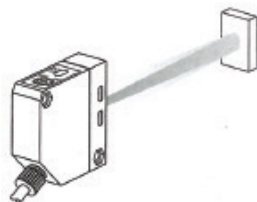

### Background suppression

Background suppression diffuse reflective sensors have, in comparison to the ones we describe above, a specific and a well defined working area. Within this area, these sensors can detect the objects almost apart from their surface and their colour. Besides this restricted and specific detection area, that is in the background zone, all the other objects are ignored apart from their surface features.

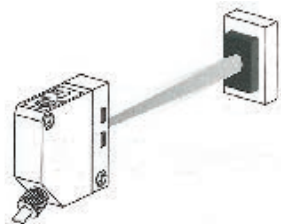

### Retro Reflective

As in Diffuse type the light source and the photosensitive element are in the same unit. Differing for the Diffuse type, the reflection of the light emitted is obtained by using a reflector. As a consequence, the detection occurs when the beam of the reflected light is interrupted, that is, when there is an object between the reflector and the sensor. This system is limited by the fact that shining or reflecting objects cannot be identified by the sensor as they reflect the emitted light, as if they were reflectors.

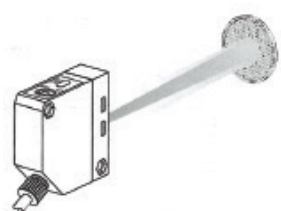

### Polarized Retro Reflective

The working principle is the same as in the retro Retro Reflective type. This sensor allows shining or reflecting objects to be sensed. This is due to the fact that reflectors deviate the light radiation of 90°. By using special polarizing filters, only the light reflected by the reflector is sensed by the photosensitive element. Therefore common reflecting objects can be sensed because they cannot the light radiation and act as the retroreflector. However if the reflecting surface is of 'active material', the light beam through this material may have the same behaviour as the reflector. This is due to the disposition of molecules of that particular material. To avoid this, is advisable to rotate the optical axis (photoelectric sensor-reflector) 45° to the surface to scan.

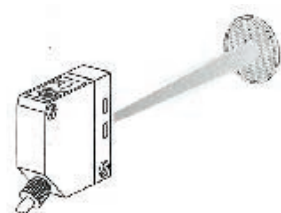

## Switching Distance for Diffuse Reflective Sensor

Detecting distance for optical proximity sensors varies according to the material to sense. The parameters that influence the maximum capacity of the sensor are mainly the colour and the brightness or roughness of the surface to be detected. The data below show approximate values and are the result of lab tests with mat paper targets 10x10 wide of the following colours.

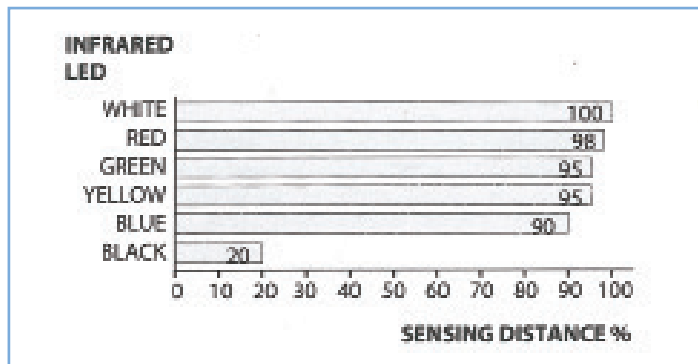

## Switching Distance for Retro Reflective Sensor and Thru-beam

It is the maximum distance between photocell and reflector or between emitter and receiver.

## Nominal Switching Distance (Sn) According to EN 60947-5-2

It is the conventional value of operating distance for photoelectric switches. It does not take into account either manufacturing tolerances ( $\pm 10\%$ ) or variations due to external conditions such as voltage and temperature.

## Usable Operating Distance (Su) According to EN 60947-5-2

It is the assured operating distance within the specified voltage, functioning and temperature intervals; it is included between 81% and 12% of the nominal switching distance Sn ( $0.81S_n \leq S_u \leq 0.12S_n$ ) for photoelectric switches.

## Assured Operating Distance (Sa) According to EN 60947-5-2

It is the distance at which the photoelectric switches works safely in all the temperature and voltage intervals as specified for the same sensor. The assured operating distance is included between 0 and 181% of Sn only in the case of photoelectric switches without blind zone and referring to specific targets.

## Blind Zone

It is the area between the 'photoelectric switches active surface' and the minimum switching distance, within which an object cannot be detected.

## Hysteresis

It is the maximum distance between the detected and non detected points. These points are obtained by moving the object towards or away from the photocell axis. Data are expressed in percentage to the value of the sensing distance.

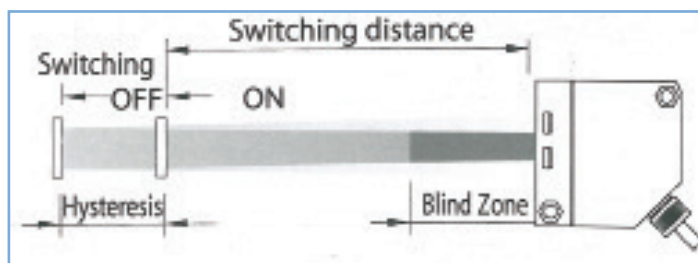

## Switching Frequency

It shows the maximum number of operations per second performed by the photocell.

## Response Time

It is the time the object takes to cover the optical sensor field to perform a correct switching.

# SAFETY LIGHT CURTAIN SELECTION GUIDE

The selection of safety sensors for use in machinery is part of the overall risk reduction process, which starts with the analysis and evaluation of all possible risks the machine presents and ends with the validation and testing of the safety system. The sensors chosen should fulfill any safety requirements specific to the machine they will be mounted on. If there are no machine-specific requirements, the safety system should be designed to comply with all general safety and health standards. The overall system design dictates the parameters the safety sensors must meet. The following list of parameters and functions related to safety sensors can serve as a checklist to help in the selection process.

Number	Definition	Values
1	Performance level (PL)	a, b, c, d, e
2	Detection capability (or resolution)	100 mm, 150 mm, 200 mm, 250 mm, 300 mm, 350 mm, 400 mm, 450 mm, 500 mm, 550 mm, 600 mm, 650 mm, 700 mm, 750 mm, 800 mm, 850 mm, 900 mm, 950 mm, 1000 mm
3	Height	1000 mm, 1500 mm, 2000 mm, 2500 mm, 3000 mm, 3500 mm, 4000 mm, 4500 mm, 5000 mm, 5500 mm, 6000 mm, 6500 mm, 7000 mm, 7500 mm, 8000 mm, 8500 mm, 9000 mm, 9500 mm, 10000 mm
4	Response time	100 ms, 150 ms, 200 ms, 250 ms, 300 ms, 350 ms, 400 ms, 450 ms, 500 ms, 550 ms, 600 ms, 650 ms, 700 ms, 750 ms, 800 ms, 850 ms, 900 ms, 950 ms, 1000 ms
5	Retrospective light curtain	Yes, No
6	Frequency	100 Hz, 150 Hz, 200 Hz, 250 Hz, 300 Hz, 350 Hz, 400 Hz, 450 Hz, 500 Hz, 550 Hz, 600 Hz, 650 Hz, 700 Hz, 750 Hz, 800 Hz, 850 Hz, 900 Hz, 950 Hz, 1000 Hz
7	Number of beams	2, 3, 4
8	Number of active elements	2, 3, 4
9	Number of passive elements	2, 3, 4
10	Number of channels	2, 3, 4
11	Number of sensors	2, 3, 4
12	Number of sensors	2, 3, 4
13	Number of sensors	2, 3, 4
14	Number of sensors	2, 3, 4
15	Number of sensors	2, 3, 4
16	Number of sensors	2, 3, 4
17	Number of sensors	2, 3, 4
18	Number of sensors	2, 3, 4
19	Number of sensors	2, 3, 4
20	Number of sensors	2, 3, 4
21	Number of sensors	2, 3, 4
22	Number of sensors	2, 3, 4
23	Number of sensors	2, 3, 4
24	Number of sensors	2, 3, 4
25	Number of sensors	2, 3, 4
26	Number of sensors	2, 3, 4
27	Number of sensors	2, 3, 4
28	Number of sensors	2, 3, 4
29	Number of sensors	2, 3, 4
30	Number of sensors	2, 3, 4
31	Number of sensors	2, 3, 4
32	Number of sensors	2, 3, 4
33	Number of sensors	2, 3, 4
34	Number of sensors	2, 3, 4
35	Number of sensors	2, 3, 4
36	Number of sensors	2, 3, 4
37	Number of sensors	2, 3, 4
38	Number of sensors	2, 3, 4
39	Number of sensors	2, 3, 4
40	Number of sensors	2, 3, 4
41	Number of sensors	2, 3, 4
42	Number of sensors	2, 3, 4
43	Number of sensors	2, 3, 4
44	Number of sensors	2, 3, 4
45	Number of sensors	2, 3, 4
46	Number of sensors	2, 3, 4
47	Number of sensors	2, 3, 4
48	Number of sensors	2, 3, 4
49	Number of sensors	2, 3, 4
50	Number of sensors	2, 3, 4

**1. Performance Level (PL) and required Performance Level (PLr)**  
 Performance level is one of five discrete levels (a, b, c, d, e) that specify the ability of the safety-related part of a control system to perform a specific safety function. The performance level depends on the system design, the reliability of components used, the diagnostic coverage of dangerous faults, and on the ability of the safety parts to avoid common cause and systematic faults. The minimum required Performance Level (PLr) to reduce a risk is determined by following the diagram in fig. 1, which takes into account three factors: the severity of injury, the frequency of exposure to hazard, and the possibility to avoid the hazard. Performance level and its calculation methods are described in EN ISO 13849-1.

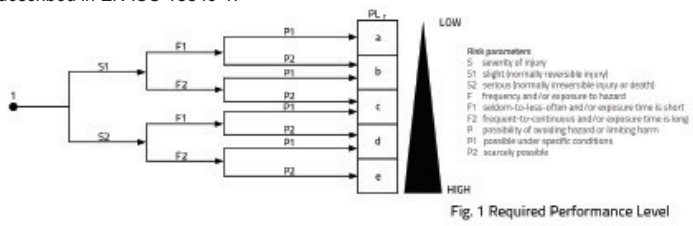

**2. Type**  
 Safety sensors whose function is to detect the interruption of beams by an object are called Active Optoelectronic Protective Devices (AOPD). AOPDs are classified in two Types (Type 2 and Type 4) depending on their design and optical performance. The optical performance is dependent on the maximum limit of the effective aperture angle (EAA), that is  $\pm 4.5^\circ$  for Type 2, and  $\pm 2.5^\circ$  for Type 4. A lower EAA results in a more focused beam. Type and Performance Level are directly correlated: Type 2 Sensors must reach at least PL c, and Type 4 Sensors must reach at least PL e. Conversely, the maximum PL that can be reached for a safety function that includes the use of a Type 2 AOPD is PL c, while for a Type 4 AOPD, the maximum is PL e. Based on these considerations, to reduce the highest risks on machines, Type 4 AOPDs should be used (see Fig. 2). Active optoelectronic protective devices and corresponding Types are described in IEC 61496-1 and IEC 61496-2.

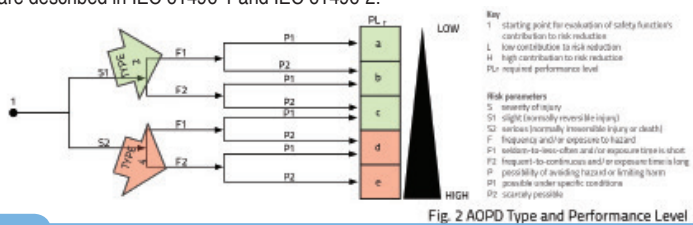

**3. Detection Capability (or Resolution)**  
 The detection capability of a light curtain is the diameter of the smaller object that will activate the device when it's placed in any point of the detection zone. The value of the detection capability, together with response time, is crucial to calculating the minimum safety distance required between the light curtain and the dangerous zone. For single light beam sensors and for multiple light beams sensors (2, 3 or 4 beams), in place of detection capability, it's common to use the number of light beams. In this case, their purpose is to provide "body protection", detecting the passage of the entire body of a person. For an introduction to the minimum safety distance calculation rules (described in EN 13855) see page 94 and the light curtain's technical documentation.

**4. Detection zone**  
 The detection zone is the area where any object whose dimensions are at least equal to the detection capability activates the light curtain. It is defined by its height and by the distance between the emitter and the receiver element ("operating range"). If the light curtain is retroreflective, the operating range is the distance between the active and the passive element. Light curtains can have a "dead zone", in which they are not able to detect the object due to the absence of beams. When it is required that the dimension of the light curtain corresponds exactly to the height of its detection zone, the light curtain is said to have zero dead zone.

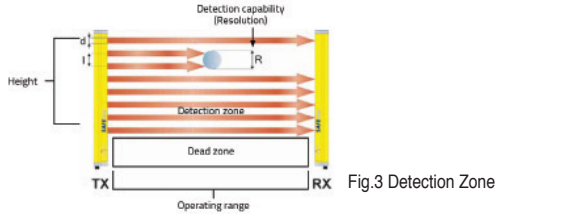

**5. Retroreflective light curtains**  
 2, 3 and 4 beams light curtains can be manufactured with all emitters and receivers on one side, and passive elements (mirrors) on the other side. The advantage of using a retroreflective light curtain is that only one side needs to be powered on.

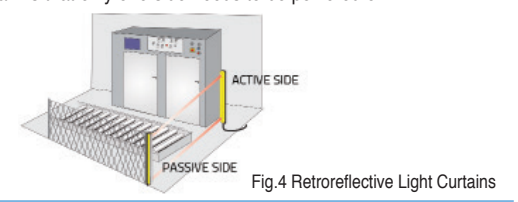

# SAFETY LIGHT CURTAIN SELECTION GUIDE

## 6. Cascading

Cascading is when two or more light curtains are connected to each other, resulting in one system that functions as a single light curtain. Advantages of cascading are: better monitoring of dangerous areas with presence detection beyond the vertical detection zone and space and cost savings by using a single safety unit.

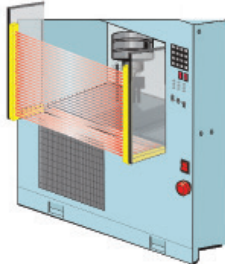

Fig.5 Cascading

## 7. Response time

The response time is the maximum time occurring between the detection of the test object in the detection zone and the activation of the light curtain's outputs. It is a safety relevant parameter, and its value must be taken in account when calculating the position in which the safety sensor will be placed in relation to the dangerous area.

## 8. Manual or automatic restart

Depending on the initial risk analysis of the machine, a start or restart interlock can be a safety requirement of the control system. It prevents an automatic restart of the machine during a dangerous part of the operating cycle after activation of the sensing device, or when the electrical supply of the sensor is switched on or restored after interruption. This interlock can be implemented by a manual restart of the safety controller or by the light curtain itself.

## 9. External Device Monitoring (EDM)

EDM is a function that allows the electro-sensitive protective equipment (ESPE) to monitor the state of control devices (i.e. contactors, actuators) that are driven by its outputs. This function can be achieved by the safety controller or directly by the light curtain.

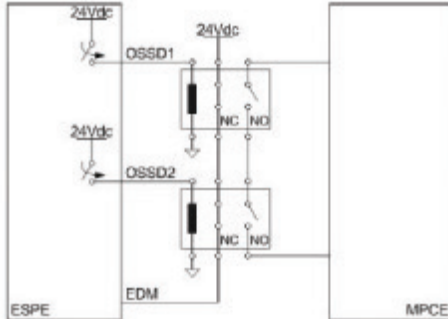

Fig.6 External Device Monitoring Wiring Diagram

## 10. Muting

Muting is the temporary automatic suspension of a safety function. When a light curtain is muted, its outputs will remain ON even if an object is detected in the detection zone. Because muting suspends a safety function, it must be implemented with all necessary precautions and in compliance with the machine-specific safety requirements. T muting is a specific kind of muting that can be used to allow the passage of material through an opening in direction of the dangerous area or in both directions. L muting can be used only if material exits the dangerous area.

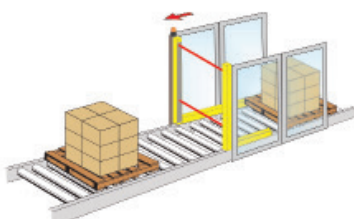

Fig.7 Safety Light Curtain with Integrated L muting actuator

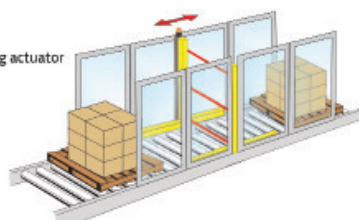

Fig.8 Safety Light Curtain with Integrated T muting actuator

Light curtains can be provided with muting arms, with pre-wired sensors detecting the passage of material, or can be used with external muting sensors.

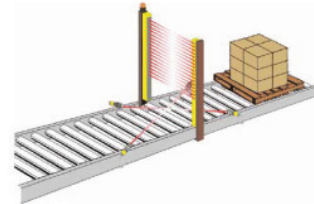

Fig.9 Safety light curtain with external crossed beams muting sensors

Muting lamps integrated in the light curtains, or installed external to them, are designed to flash as long as the muting is active.



Fig.10 Intergrated Muting Lamps

To maintain the safety of the application, light curtains can be configured to perform the muting function only on the number of beams needed for the passage of the material (Partial Muting), keeping the others active.

## 11. Override

Override function is a mute dependent bypass of the light curtain, that can be provided for some applications (for example conveyor and packaging machinery) in order to clear a blockage in the area of the machine where sensors are located. The activation of the bypass function should be possible for a limited amount of time, only when at least one muting sensor is activated, and will require the use of a device located where operator can see the point of hazard.

## 12. Blanking

The blanking function is used when an object detected in a defined part of the detection zone must not cause an OFF-state of the light curtains outputs. Blanked beams are monitored so that the absence or a change in the size or location of the object causes the light curtain's outputs to go to the OFF-state. Fixed blanking is when the object must remain in a fixed position, with a given tolerance. Floating blanking is when the object can move along the detection zone. Depending on the configuration of the light curtain, in floating blanking the object can also leave the detection zone or not. Reduced resolution is a particular kind of floating blanking, with light curtain outputs going OFF-state only when a predefined number of beams adjacent are interrupted, in any position along the light curtain. When reduced resolution is active, more than one small object can interrupt the light curtain beams without its output going OFF. Blanking can affect the detection capability of the light curtain and can result in a recalculation of the minimum safety distance.

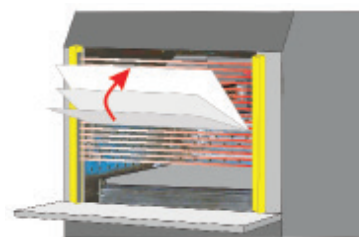

Fig.11 Floating Blanking

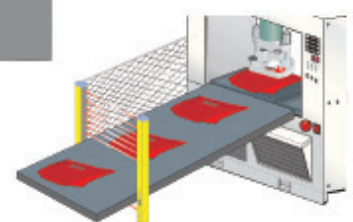

Fig.12 Fixed Blanking with Tolerance

## 13. Software configuration

Setting DIP-Switch or through wiring, it is possible to set typical parameters like manual or auto reset, EDM enable or disable, muting type selection, as well as auto-teach blanking function. A software configurator (Graphic User Interface, GUI) is required for more advanced functionality, such as setting the muting timeout with 1-second steps, or designing complex patterns for floating or fixed blanking.



# SAFETY LIGHT CURTAIN SELECTION GUIDE

<p>Finger (14mm)</p> <p>Type 4</p>	4	0.2...6	150...1800
		0.2...7	300...1800
<p>Hand (30mm)</p> <p>Type 2</p>	2	0.2...19	150...1800
		0.2...19	150...1800
	4	0.2...20	300...1800
		0.2...19	150...1800
<p>Arm/Presence (50/90mm)</p> <p>Type 2</p>	2	0.2...19	150...1800
		0.2...19	150...1800
<p>Body (2/3/4 Beams)</p> <p>Type 2</p> <p>Type 2</p>	2/4	0.5...50	500/800/900/1200
		0.5...50 0.5...3 <sup>A</sup> 0.5...7 <sup>B</sup>	500/800/900/1200
		0.5...60	500/800/900/1200
		0.5...60 0.5...3 <sup>A</sup> 0.5...7 <sup>B</sup>	500/800/900/1200
		0.5...8	500/800/900/1200
		0.5...8 0.5...3 <sup>A</sup>	500/800/900/1200
		0...8 <sup>C</sup> 0...40 <sup>C</sup>	Flexible

## Notes



- <sup>A</sup> With retroreflective muting arms
- <sup>B</sup> With emitter/receiver muting arms
- <sup>C</sup> Depending on models



Information in this publication is provided to guide customers in the choice of products in DATALOGIC portfolio. It has to be considered indicative and concise. For the correct use of safety components described, please always refer to additional information you can find on products datasheets and manuals, as well as to the legislation in force at the moment and in the country of their use.

# SAFETY LIGHT CURTAIN SELECTION GUIDE

Functions	Additional HW Features	Family	Page
Manual/Auto Restart		<b>SG4 BASE</b>	45
External Device Monitoring (EDM)			
Manual/Auto Restart	Zero dead zone Cascade Advanced Programmable Configuration Monitoring via Erthnet/IP Error logging	<b>SG4 EXTENDED</b>	46
External Device Monitoring (EDM)			
T, L Muting Function			
Partial Muting			
Override			
Fixed blanking			
Floating Blanking			
Auto restart		<b>SG2 BASE</b>	45
Manual/Auto Restart		<b>SG2 EXTENDED</b>	45
External Device Monitoring (EDM)			
Manual/Auto Restart	Zero dead zone	<b>SG2 MUTING</b>	46
External Device Monitoring (EDM)			
T, L Muting function			
Partial Muting			
Override			
Manual/Auto Restart		<b>SG4 BASE</b>	45
External Device Monitoring (EDM)			
Manual/Auto Restart	Zero dead zone Cascade Advanced Programmable Configuration Monitoring via Erthnet/IP Error logging	<b>SG4 EXTENDED</b>	46
External Device Monitoring (EDM)			
T, L Muting function			
Partial Muting			
Override			
Fixed blanking			
Floating Blanking			
Auto restart		<b>SG2 BASE</b>	47
Manual/Auto Restart		<b>SG2 EXTENDED</b>	
External Device Monitoring (EDM)			
Manual/Auto Restart		<b>SG BODY COMPACT BASE</b>	46
External Device Monitoring (EDM)			
Manual/Auto Restart	Intergrated muting lamp Intergrated muting arms <sup>c</sup>	<b>SG BODY COMPACT MUTING</b>	46
External Device Monitoring (EDM)			
T, L Muting function			
Manual/Auto Restart		<b>SG BODY BIG BASE</b>	47
External Device Monitoring (EDM)			
Manual/Auto Restart	Intergrated muting lamp	<b>SG BODY BIG MUTING</b>	47
External Device Monitoring (EDM)			
T, L Muting function			
Override			
Manual/Auto Restart	Retroreflective	<b>SG BODY REFLECTOR BASE</b>	47
External Device Monitoring (EDM)			
Manual/Auto Restart	Retroreflective Intergrated muting lamp Intergrated muting arms <sup>c</sup>	<b>SG BODY REFLECTOR MUTING</b>	47
External Device Monitoring (EDM)			
T, L Muting function			
Override			
Manual/Auto Restart	Double muting function Low temperature Defogging Separated control unit	<b>SINGLE BEAM SENSORS</b>	48
External Device Monitoring (EDM)			
T, L Muting function			
Override			

ACCESSORIES		
Safety Accessories		50-51
Safety Control Units, Relays and Connector Boxes		49

# SAFETY LIGHT CURTAIN REFERENCE GUIDE FOR SG-PSB & SG-PSM STANDS

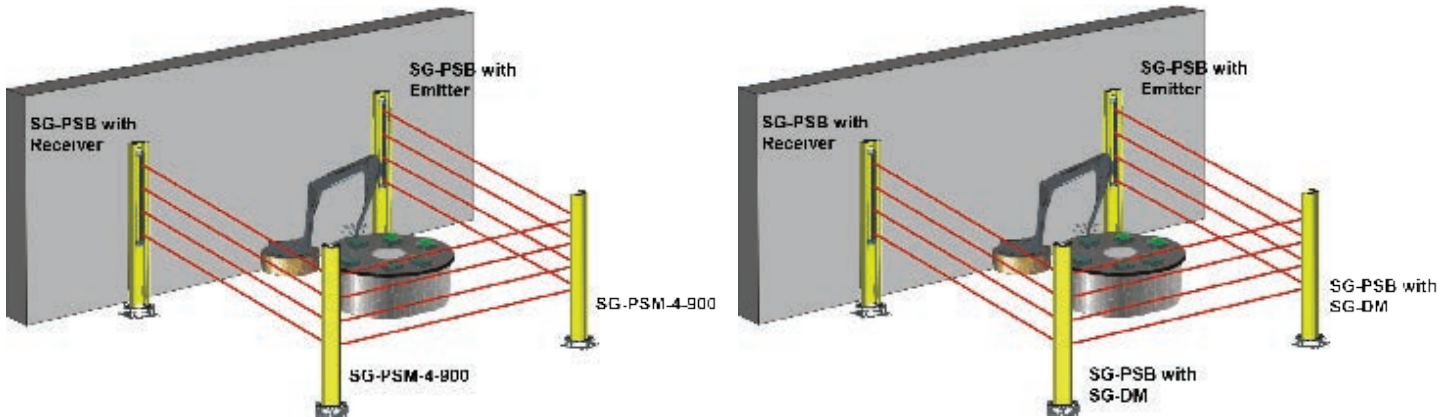

**Corresponding Table**

SG-PSM	Corresponding Safety Light Curtian	SG-PSM	Corresponding Safety Light Curtian
SG-PSM-2-500	SG2-S2-050-PP-E	SG-PSM-4-900	SG2-S4-090-PP-E
	SG2-S2-050-PP-W		SG2-S4-090-PP-W
	SG4-S2-050-PP-E		SG4-S4-090-PP-E
	SG4-S2-050-PP-W		SG4-S4-090-PP-W
	SG2-B2-050-OO-E		SG2-B4-090-OO-E
	SG2-B2-050-OO-W-C		SG2-B4-090-OO-W-C
	SG4-B2-050-OO-E		SG4-B4-090-OO-E
SG-PSM-3-800	SG4-BLR2-050-OO-W-C	SG-PSM-4-1200	SG4-BLR4-090-OO-W-C
	SG2-S3-080-PP-E		SG2-S4-120-PP-E
	SG2-S3-080-PP-W		SG2-S4-120-PP-W
	SG4-S3-080-PP-E		SG4-S4-120-PP-E
	SG4-S3-050-PP-W		SG4-S4-120-PP-W
	SG2-B3-080-OO-E		SG2-B4-120-OO-E
	SG2-B3-080-OO-W-C		SG2-B4-120-OO-W-C
	SG4-B3-080-OO-E		SG4-B4-120-OO-E
	SG4-BLR3-080-OO-W-C		SG4-BLR4-120-OO-W-C
	SG4-BSR3-080-OO-W-C		SG4-BSR4-120-OO-W-C

**Mirrors - Safety Light Curtains Correspondance Table**

Mirror Models	Corresponding Light Curtian	Mirror Models	Corresponding Safety Light Curtian
SG -DM 600	SGX -XX -015	4X SG -DM 150 / SG -DM 1200	SG2-S4-090
SG -DM 600	SGX -XX -030	4X SG -DM 150 / SG -DM 1200	SG4-S4-090
SG -DM 600	SGX -XX -045	4X SG -DM 150 / SG -DM 1200	SG2-B4-090
SG -DM 900	SGX -XX -060	4X SG -DM 150 / SG -DM 1200	SG4-B4-090
SG -DM 900	SGX -XX -075	4X SG -DM 150 / SG -DM 1200	SG4-BLR4-090
2X SG -DM 150 / SG -DM 900	SG2-S2-050	4X SG -DM 150 / SG -DM 1200	SG4-BSR4-090
2X SG -DM 150 / SG -DM 900	SG4-S2-050	SG -DM 1650	SGX -XX -120
2X SG -DM 150 / SG -DM 900	SG2-B2-050	SG -DM 1650	SGX -XX -135
2X SG -DM 150 / SG -DM 900	SG4-B2-050	SG -DM 1650	SGX -XX -150
2X SG -DM 150 / SG -DM 900	SG4-BLR2-050	4X SG -DM 150 / SG -DM 1650	SG2-S4-120
2X SG -DM 150 / SG -DM 900	SG4-BSR2-050	4X SG -DM 150 / SG -DM 1650	SG4-S4-120
SG -DM 1200	SGX -XX -090	4X SG -DM 150 / SG -DM 1650	SG2-B4-120
SG -DM 1200	SGX -XX -105	4X SG -DM 150 / SG -DM 1650	SG4-B4-120
3X SG -DM 150 / SG -DM 1200	SG2-S3-080	4X SG -DM 150 / SG -DM 1200	SG4-BLR4-120
3X SG -DM 150 / SG -DM 1200	SG4-S3-080	4X SG -DM 150 / SG -DM 1200	SG4-BSR4-120
3X SG -DM 150 / SG -DM 1200	SG2-B3-080	SG -DM 1650	SG4-40-120
3X SG -DM 150 / SG -DM 1200	SG4-B3-080	SG -DM 1900	SGX -XX -165
3X SG -DM 150 / SG -DM 1200	SG4-BLR3-080	SG -DM 1900	SGX -XX -180
3X SG -DM 150 / SG -DM 1200	SG4-BSR3-080		



## ORDERING SUMMARY TABLE FOR MUTING ACCESSORIES

Safety Light Curtain	Muting	Type	SG-L-ARM	SG-T-ARM	SG-AS-ARM	SG-PR-ARM	SG-CB-B	SG-CB-C	CV-L1-02-B-007	CV-Y1-02-B-007	SG-F1G1-ARMS	SG-F2G2-ARMS
<b>SG BODY BIG MUTING</b>	L	RRX			1	1	2		1			
	T	RRX			2	2	2			1		
	L	F/G					2		2		1	
	T	F/G					2			2	1	1
<b>SG BODY REFLECTOR (Active &amp; Passive)</b>	L	RRX			1	1	2		1			
	T	RRX			2	2	2			1		
<b>SG BODY COMPACT MUTING</b>	L	RRX	1									
	L	RRX			1	1		2	1			
	T	RRX		1								
	T	RRX			2	2		2		1		
	L	F/G						2	2		1	
	T	F/G						2		2	1	1

**Note:** RRX = Active/Passive retroreflective muting arms. F/G = Emitter/Receiver muting arms

- 1) To realize an L muting with retroreflective arms starting from a **SG BODY COMPACT MUTING**, order the complete kit **SG-L-ARMS** or, in alternative, the following: **1x SG-AS-ARM, 1x SG-PR-ARM, 2x SG-CB-C, 1x CV-L1-02-B-007**.
- 2) To realize a T muting with emitter/receiver arms, starting from a **SG BODY BIG MUTING**, order the following: **2x SG-CB-B, 2x CV-Y1-02-B-007, 1x SG-F1G1-ARMS, 1x SG-F2G2-ARMS**.

## OPTICAL ROTARY ENCODERS DIMENSIONS

**Basic Line Incremental 41mmØ**

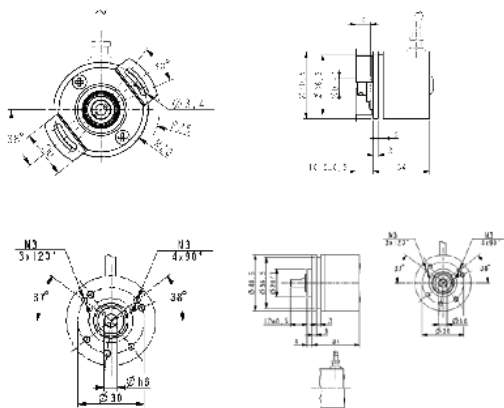

**Multi-turn with Modular Fieldbus Interface Absolute 58mmØ**

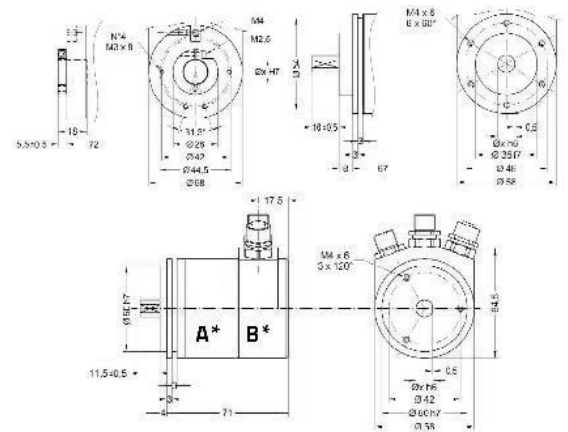

**Extended Line Incremental 58mmØ**

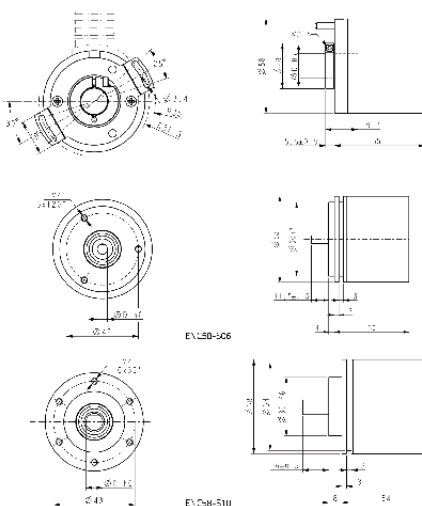

**SSI Single-turn Absolute 58mmØ**

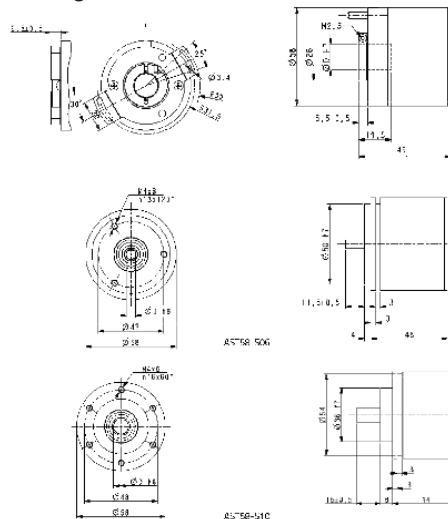

**SSI Multi-turn Absolute 58mmØ**

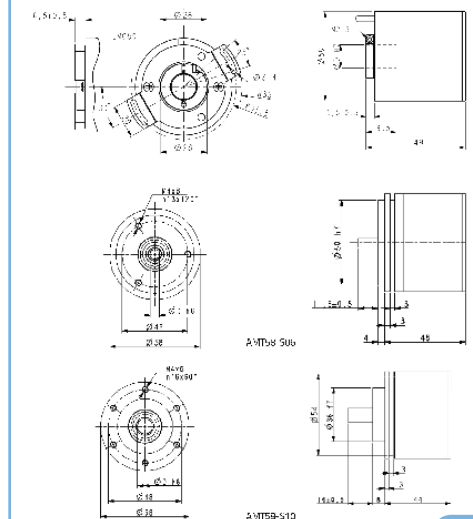

# PROXIMITY SWITCH SPECIFICATIONS

## Inductive Sensors

Inductive proximity sensors generate a magnetic field from their detection faces. Whenever a detectable object moves into the sensor's field of detection, Eddy currents build up in the target and dampen the sensor's magnetic field. This effect triggers the sensor's output. Since a current in the target is needed for detection, inductive proximity sensors are uniquely suited for detection of all types of metals.

### ADVANTAGES

- Not affected by humidity and dust
- No moving parts, no mechanical wear
- Independent of the color of the object to detect
- No dead zone

### DISADVANTAGES

- only detect metallic objects
- low operating distance
- sensitive to electromagnetic interference (such as electric welding, induction ovens)

### Shielded models - FLUSH mounting

Shielded models can be installed with their sensing faces flush to the metal. The distance from opposing metal surfaces must be  $\geq 3s_n$  and the distance between two proximity switches (side-by-side)  $\geq 2D$ .

### Unshielded models - NON-FLUSH mounting

Unshielded models can be identified by their "caps", since they have no metal housing surrounding the area of the sensing face. The sensing face must extend  $\geq 2s_n$  from the metallic installation medium. The distance from opposing metal surfaces must be  $\geq 3s_n$  and the distance between two adjacent proximity switches  $\geq 3D$ . The metal body leaves uncovered part of the sensing area resulting in an increased sensing distance.

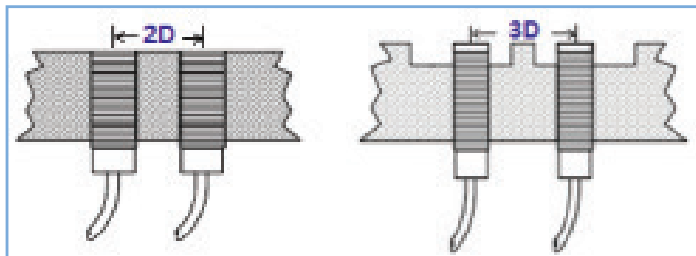

Main tubular models are available in both nickel plated brass and stainless steel housing, with the active sensing face in LCP plastic.

### METAL FACE version

Are available stainless steel versions (M12, M18). Are used in especially harsh environments and applications which are too extreme for standard sensors. They resist to abrasive media, aggressive cleaners and solvents with their rugged sensing face. IP67 protection.

### WELD FIELD IMMUNE version

These special field immune models are ideal for welding environments and other applications where large magnetic fields are present. They are rated for reliable operation near the current line carrying 20,000 amps.

### NAMUR version

Are available 2 wires versions (M5, M6,5, M8, M12, M18, M30). They can be used in conjunction with suitable switching amplifiers, in explosive systems or Zone 1 and Zone 2 areas. The switch amplifier must be installed outside the explosive area. Almost all versions have IP67 mechanical protection. Nominal Switching distance ( $s_n$ ) According to EN 60947-5-2  
When an inductive proximity sensor is rated for sensing distance, it refers to the sensor's ability to detect the "standard detectable object" at its specified sensing distance. The "standard detectable object" is a 1mm thick square piece of ferrous iron that is in height and width the size of the proximity sensor's detection face's diameter.



When the object to be detected is a different metal material, multiply the value of the rated operating distance for a reduction factor. To the right is a table with the reduction factors of the main metals used in industry.

### REDUCING FACTOR

Fe37	1 x $s_n^*$
Stainless-Steel	0,9 x $s_n$
Brass-Bronze	0,5 x $s_n$
Alluminium	0,4 x $s_n$
Copper	0,3 x $s_n$

### Hysteresis (H)

distance between the point of switching on and the point of switching off of the trigger object. The value is a percentage of the nominal switching distance  $s_n$ .

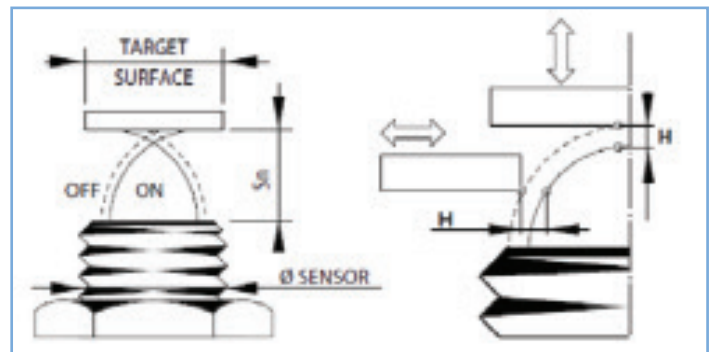

### AC/DC version

Are available 2/3-wires versions (M12, M18, M30), that operate in alternating current with voltage drop of 5 V for currents of the order of 100mA.

To be able to provide a proper potential drop at the load, it is recommended to power the sensors with at least a supply voltage equal to the Voltage drop indicated (5V).

M12/18/30 FLUSH models are ATEX certified



I I 3G EX nA II T6  
I I 3D EX tD A22 IP67 T85°C

"M12/18/30 models are Diversey and ECOLAB tested"



# PROXIMITY SWITCH SPECIFICATIONS

## OPERATING DISTANCE

MODEL	M4	M5	M6.5	M8	M12	M18	M30	SQUARE
Diameter (mm)	4	5	6.5	6.5	12	18	30	8x8, 40x40
Operating Distance (mm)	0,8	0,8/1,5	1/3	1.5/3	2/8	5/14	10/20	1,5/30

## HOUSING LENGTHS

The following table shows the approximate length (mm) intervals for all categories and models of tubular inductive sensors.

MODEL	STANDARD		SHORT	
	connector	cable	connector	cable
M4	...	25	...	...
M5	40	20/25	...	...
M6.5	53/63	46/55	50/54	40/44
M8	52/73	44/55	48/57	40/44
M12	68/72	58/64	48/54	42/48
M18	73/82	70/78	56/65	47/56
M30	74/85	70/82	56/82	49/56

## WIRES

TYPE	DESCRIPTION
2-3 WIRES	Work with sinking or sourcing devices Vdc, Vac and NAMUR versions Higher leakage current
3 WIRES	Must select PNP or NPN, NC or NO version 10-30 Vdc version Low leakage current
4 WIRES	Programmable output PNP/NPN and NC/NO in one device

The number of inductive proximity sensors that can be connected in series or parallel is limited.

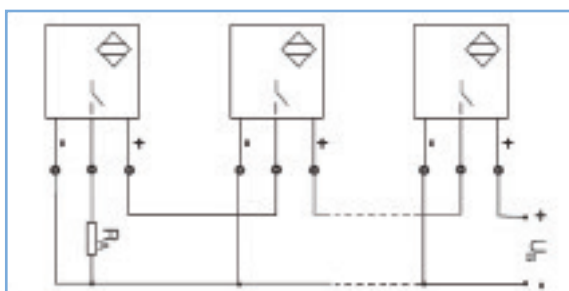

Parallel connection: the leakage current of each single sensor, when added to the other, may accumulate and drive the load even in the absence of operated switches.

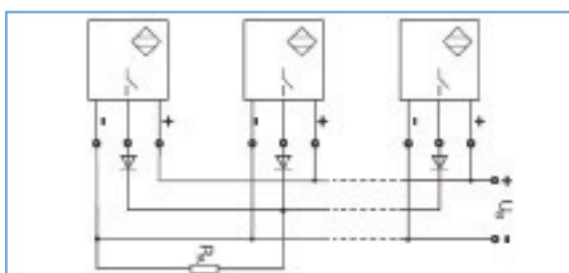

This problem is more relevant in versions AC 2-wire, because of the high voltages and currents supplied to the sensor. For this type of connection you should use a 3-wire sensors working in DC.

## NOMINAL VOLTAGE

Is the permissible voltage range in which certain safe operation of the switch is guaranteed.

## RESIDUAL RIPPLE

Is the maximum admissible ripple of the DC supply voltage shown as percentage to its medium value.

## MAX. OUTPUT CURRENT

It shows maximum output current a sensor can cope with when working steadily.

## MIN. OUTPUT CURRENT

Is the smallest load current required for function of the switch when ON.

## RESIDUAL CURRENT

Is the current flowing through the load when a proximity switch is not conducting (open).

## VOLTAGE DROP

Is the voltage measured across the load of a closed (conducting) sensor at load current.

## START UP DELAY

Is the time from when the supply voltage is applied, and the proximity switch assumes the ready state. This time may not be longer than 300 ms. During this time there must be no fault signal longer than 2 ms.

## SWITCHING FREQUENCY

Refers to the maximum number of switching operations per second.

## SHORT CIRCUIT PROTECTION

Is 100 A, i. e., per EN 60947-5-2 the power supply during testing in short circuit mode must be able to provide at least 100 A for a short duration. This current is prescribed in the standard in order to test.

## PROTECTION AGAINST INVERSION OF POLARITY

Available in DC supplied type, it prevents the sensor from being damage when supply cables are incorrectly connected.

## INDUCTIVE LOAD PROTECTION

It protects sensor output in presence of high inductive loads. This protection is performed by a diode or zener diode.







#### LONGMEADOW

26 Nguni Drive, Longmeadow  
Business Estate West, Edenvale  
Gauteng

Tel: +27 10 202 3300

Fax: +27 10 202 3365

Email: [info@acdc.co.za](mailto:info@acdc.co.za)

#### GERMISTON

Sharland Street, Driehoek,  
Germiston, Gauteng

Tel: +27 11 418 9600

Fax: +27 11 418 9633

Email: [germiston@acdc.co.za](mailto:germiston@acdc.co.za)

#### CAPE TOWN

8 Paarden Eiland Road,  
Paarden Eiland, Cape Town

Tel: +27 21 492 2000

Fax: +27 87 807 5279

Email: [cape@acdc.co.za](mailto:cape@acdc.co.za)

#### PINETOWN

Unit 10, Pine Industrial Estate  
Pineside Road, New Germany  
Pinetown, Kwa-Zulu Natal

Tel: +27 31 700 4215

Fax: +27 31 700 4330

Email: [kzn@acdc.co.za](mailto:kzn@acdc.co.za)

#### RIVERHORSE

6 Riverhorse Close Riverhorse  
Valley Business Estate,  
Durban, Kwa-Zulu Natal

Tel: +27 31 492 4800

Fax: +27 87 405 0775

Email: [rvh@acdc.co.za](mailto:rvh@acdc.co.za)

#### FOLLOW US ON SOCIAL MEDIA



AC/DC SFC AUTOMATION



3rd Edition April 2020

Specifications are subject to change from time to time, without notification in this publication.

© ACDC Dynamics 2019

#### NATIONAL CALL CENTRE

SALES - 010 202 3400 | TECHNICAL - 010 202 3500

