

SPF12-100

Talent TD-LFP series use quality trustable LiFePO₄ cells, with build-in BMS system. IP65 protection, support series and parallel use, is an ideal choice for outdoor, small energy storage, marine and other fields.

Features

- . Safest lithium battery technology
- . Lithium iron Phosphate Battery(LiFePO₄)
- . Eco-friendly
- . Special protection plate, supporting parallel
- . Multiple safety protection
- . Intelligent balancing function
- . 20 Years Designed service life

Mechanical Specifications

Case Material	ABS
Cell Type -Chemistry	Prismatic LiFePO ₄
Terminal Type	M8
IP Grade	IP65

BMS Characteristics

Recommended Charge Current	50A
Maximum Charge Current	100A
Maximum Continuous Discharge Current	100A
Recommended Charge Voltage	13.6~13.8V
Max Charge Voltage	14.4V
Overcharge Protection Voltage	14.8~15.0V
Charge Mode	CC/CV
Discharge Cut-off Voltage (BMS)	8.8V

Basic Performance

Nominal Voltage	12.8V
Nominal Capacity	100Ah
Standard Discharge Time	100A @60min
Energy	1.28K Wh
IR	<= 15mQ
Self Discharge	<=2%/Month
Cells	Square 100Ah
Cycle Life	2500 times
Size	306*169*215
Weight	10.1

Compliance

Certifications	CE/UN38.3/UL1642/IEC62133
Transport Appraisal	UN3480,CLASS 9



Charge Performance

Rated Charge Current	50A
Maximum Charge Current	100A
Rated Charge Voltage	13.6~13.8V
Charge Cut-off Voltage	> 14.8V(0.5~1.5S)
Reconnect Voltage	<14.4 V
Balancing Voltage	< 14V
System Series	<=4

Discharge Performance

Rated Discharge Current	100A
Pulse Current(<=5S)	600A
Rated Discharge Cut-off Voltage	11.2V
Minimum Discharge Cut-off Voltage	>10V
Reconnect Voltage	>10.4V
Short Circuit Protection	200~800 μs
Short Circuit Current	Approx. 1200A

Temperature Performance

Discharge Temperature	-20~60°C
Charge Temperature	0~45°C
Storage Temperature	-5~35°C
High Temperature Cut-off	70°C
Reconnect Temperature	50°C

Size

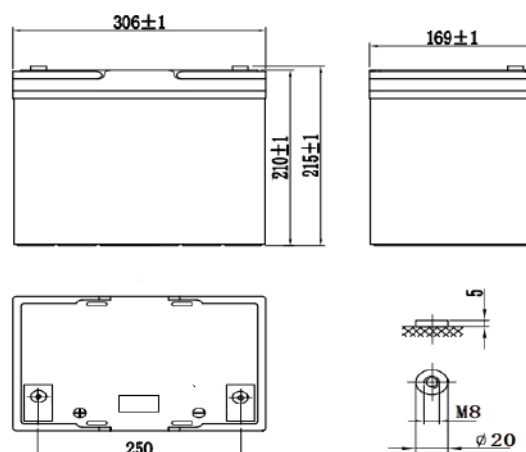

Characteristics Curve

Discharge Performance at 25 °C

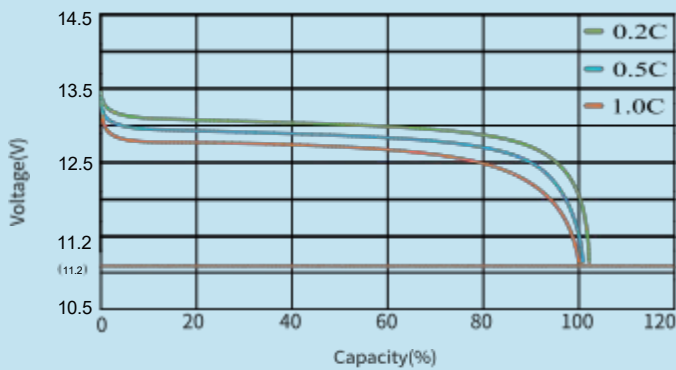

Charge and Discharge at 25°C, 0.5C

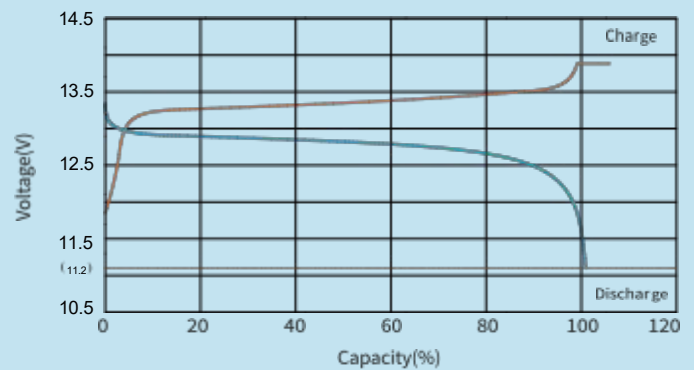

Temperature Effects on Capacity at 0.5C

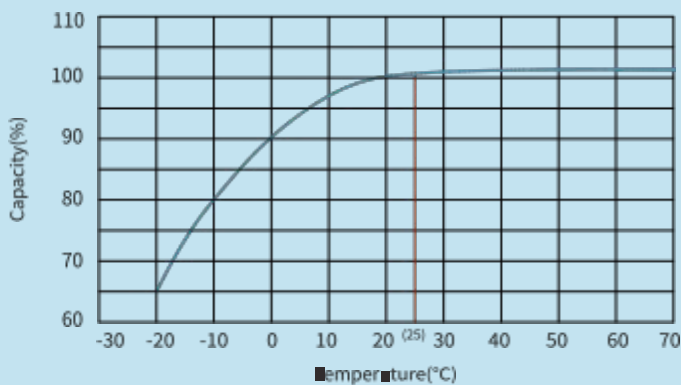

Cycle Life with DOD @ 0.5°C, 25°C

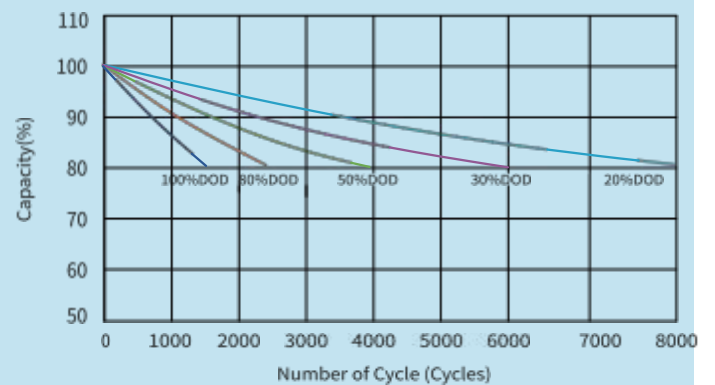

Cautions

1. Do NOT short circuit, crush or disassemble.
2. Do NOT heat or incinerate.
3. Do NOT immerse in any liquid.
4. Store at 50% capacity. Recharge every 3 months. The storage area should be clean, cool, dry and ventilated.
5. Disconnect charging source prior to connecting or disconnecting battery terminals.
6. Do not dispose of batteries in a fire as they can explode.
7. Do not open, alter, or mutilate batteries. Released electrolyte is harmful to skin and eyes. It may be toxic.
8. Do not mix different types and brands of lithium-ion batteries.
9. Do not dispose in trash, follow local regulations and manufacturer's instruction.
10. See installation instructions before connecting to the supply.
11. The battery cabinet receives power from more than one source. Disconnection of all DC sources is required to De-energize this unit before installing or servicing.
Wait 5 minutes before opening the unit.
12. Do not install on or over combustible surfaces.
13. Refer to manual before servicing.
14. Do not touch bare terminals.

USER'S MANUAL

SOLAR INVERTER

2KW- 3KW



Your best choice in power solution

Appliances



PC



TV



Air-
conditioning



Fridge



Washing
machine

Table Of Contents

ABOUT THIS MANUAL	1
Purpose.....	1
Scope.....	1
SAFETY INSTRUCTIONS	1
INTRODUCTION	2
Features.....	2
Basic System Architecture.....	2
Product Overview.....	3
INSTALLATION	4
Unpacking and Inspection.....	4
Preparation.....	4
Mounting the Unit.....	4
Battery Connection.....	5
AC Input/Output Connection.....	6
PV Connection	8
Final Assembly.....	9
Communication Connection.....	10
Dry Contact Signal.....	10
OPERATION	11
Power ON/OFF.....	11
Operation and Display Panel.....	11
LCD Display Icons.....	12
LCD Setting.....	14
Fault Reference Code.....	19
Warning Indicator.....	20
Operating Mode Description.....	21
Display Setting.....	22
SPECIFICATIONS	23
Table 1 Line Mode Specifications.....	23
Table 2 Inverter Mode Specifications.....	24
Table 3 Charge Mode Specifications.....	25
Table 4 General Specifications.....	26
TROUBLE SHOOTING	27
Appendix: Approximate Back-up Time Table	28

ABOUT THIS MANUAL

Purpose

This manual describes the assembly, installation, operation and troubleshooting of this unit. Please read this manual carefully before installations and operations. Keep this manual for future reference.

Scope

This manual provides safety and installation guidelines as well as information on tools and wiring.

The following cases are not within the scope of warranty:

- (1) Out of warranty.
- (2) Series number was changed or lost.
- (3) Battery capacity was declined or external damaged.
- (4) Inverter was damaged caused of transport shift, remissness, ect external factor.
- (5) Inverter was damaged caused of irresistible natural disasters.
- (6) Not in accordance with the electrical power supply conditions or operate environment caused damage.

SAFETY INSTRUCTIONS



WARNING: This chapter contains important safety and operating instructions. Read and keep this manual for future reference.

1. Before using the unit, read all instructions and cautionary markings on the unit, the batteries and all appropriate sections of this manual.
2. **CAUTION** --To reduce risk of injury, charge only deep-cycle lead acid type rechargeable batteries. Other types of batteries may burst, causing personal injury and damage.
3. Do not disassemble the unit. Take it to a qualified service center when service or repair is required. Incorrect re-assembly may result in a risk of electric shock or fire.
4. To reduce risk of electric shock, disconnect all wirings before attempting any maintenance or cleaning. Turning off the unit will not reduce this risk.
5. **CAUTION** – Only qualified personnel can install this device with battery.
6. **NEVER** charge a frozen battery.
7. For optimum operation of this inverter/charger, please follow required spec to select appropriate cable size. It's very important to correctly operate this inverter/charger.
8. Be very cautious when working with metal tools on or around batteries. A potential risk exists to drop a tool to spark or short circuit batteries or other electrical parts and could cause an explosion.
9. Please strictly follow installation procedure when you want to disconnect AC or DC terminals. Please refer to INSTALLATION section of this manual for the details.
10. Fuses (1 piece of 150A,63VDC for 2-3KW) are provided as over-current protection for the battery supply.
11. **GROUNDING INSTRUCTIONS** -This inverter/charger should be connected to a permanent grounded wiring system. Be sure to comply with local requirements and regulation to install this inverter.
12. **NEVER** cause AC output and DC input short circuited. Do NOT connect to the mains when DC input short circuits.
13. **Warning!!** Only qualified service persons are able to service this device. If errors still persist after following troubleshooting table, please send this inverter/charger back to local dealer or service center for maintenance.

INTRODUCTION

This is a multi-function inverter/charger, combining functions of inverter, solar charger and battery charger to offer uninterruptible power support with portable size. Its comprehensive LCD display offers user-configurable and easy-accessible button operation such as battery charging current, AC/solar charger priority, and acceptable input voltage based on different applications.

Features

- Pure sine wave inverter
- Configurable input voltage range for home appliances and personal computers via LCD setting
- Configurable battery charging current based on applications via LCD setting
- Configurable AC/Solar Charger priority via LCD setting
- Compatible to mains voltage or generator power
- Auto restart while AC is recovering
- Overload/ Over temperature/ short circuit protection
- Smart battery charger design for optimized battery performance
- Cold start function

Basic System Architecture

The following illustration shows basic application for this inverter/charger. It also includes following devices to have a complete running system:

- Generator or Utility.
- PV modules (option)

Consult with your system integrator for other possible system architectures depending on your requirements.

This inverter can power all kinds of appliances in home or office environment, including motor-type appliances such as tube light, fan, refrigerator and air conditioner.

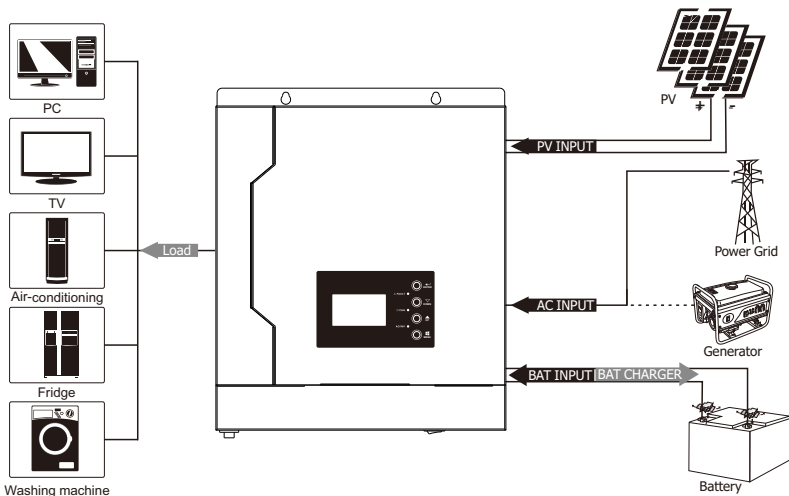
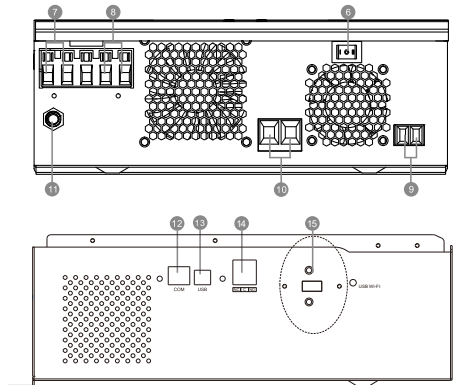
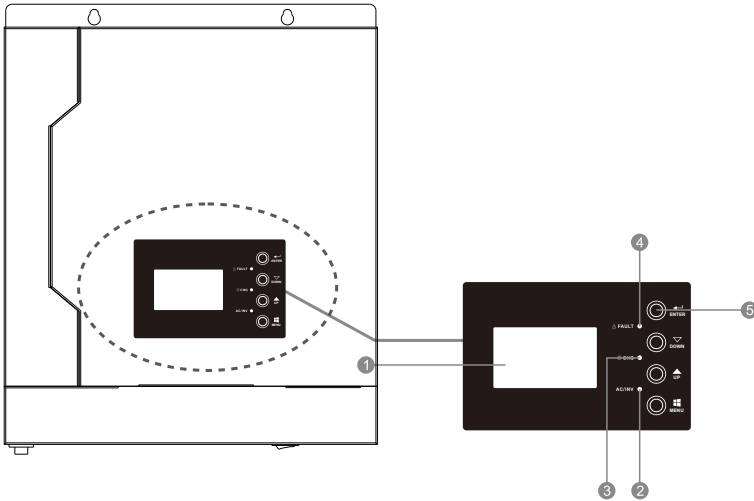

Figure 1 Hybrid Power System

Product Overview



2-3KW single model

- | | | |
|--------------------|---------------------|-----------------------------------|
| 1. LCD display | 2. Status indicator | 3. Discharging/Charging indicator |
| 4. Fault indicator | 5. Function buttons | 6. Power on/off switch |
| 7. AC input | 8. AC output | 9. PV input |
| 10. Battery input | 11. Circuit breaker | 12. RS-485 communication port |
| 13. USB | 14. Dry Contact | 15. USB WIFI |

INSTALLATION

Unpacking and Inspection

Before installation, please inspect the unit. Be sure that nothing inside the package is damaged. You should have received the following items inside of package:

- The unit x 1
- User manual x 1
- USB cable x 1

Preparation

Before connecting all wirings, please take off bottom cover by removing two screws as shown below.

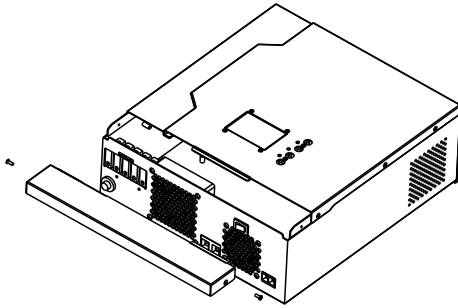

Mounting the Unit

Consider the following points before selecting where to install:

- Do not mount the inverter on flammable construction materials.
- Mount on a solid surface
- Install this inverter at eye level in order to allow the LCD display to be read at all times.
- For proper air circulation to dissipate heat, allow a clearance of approx. 200 mm to the side and approx. 300 mm above and below the unit.
- The ambient temperature should be between 0°C and 55°C to ensure optimal operation.
- The recommended installation position is to be adhered to the wall vertically.
- Be sure keep other objects and surfaces as shown in the below diagram to guarantee sufficient heat dissipation and to have enough space for removing wires.

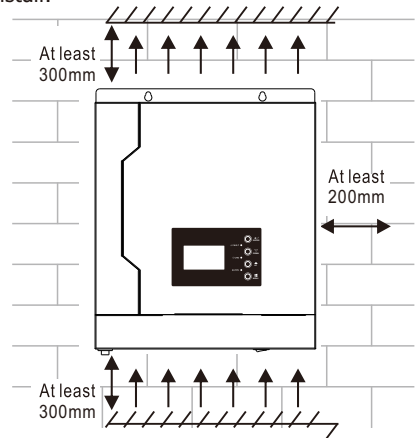

SUITABLE FOR MOUNTING ON CONCRETE OR OTHER NON-COMBUSTIBLE SURFACE ONLY.

Install the unit by screwing two screws.

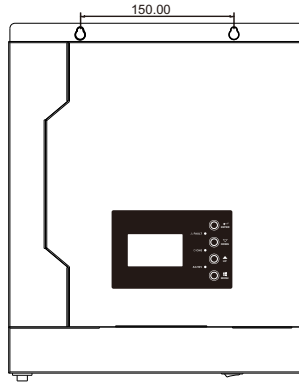

2-3KW

Battery Connection

CAUTION: To safety operation and regulation compliance, it's requested to install a separate DC over-current protector or disconnect device between battery and inverter. It may not be requested to have a disconnect device in some applications, however, it's still requested to have over-current protection installed. Please refer to typical amperage in below table as required fuse or beaker size.

WARNING! All wiring must be performed by a qualified personnel.

WARNING! It's very important for system safety and efficient operation to use appropriate cable for battery connection. To reduce risk of injury, please use the proper recommended cable and terminal size as below.

Ring terminal:

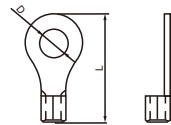

Recommended battery cable and terminal size:

Model	Typical Amperage	Battery capacity	Wire Size
2KW	84A	100AH	1*6AWG
		200AH	2*6AWG
3KW	125A	100AH	1*4AWG
		200AH	2*6AWG

Please follow below steps to implement battery connection:

1. Assemble battery ring terminal based on recommended battery cable and terminal size.
2. 2KW/3KW model supports 24VDC system. Connect all battery packs as below chart, It's suggested to connect at least 100Ah capacity battery for 2KW-3KW model.

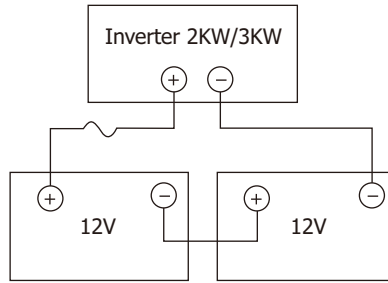

3. Insert the ring terminal of battery cable flatly into battery connector of inverter and make sure the bolts are tightened with torque of 2-3 Nm. Make sure polarity at both the battery and the inverter/charge is correctly connected and ring terminals are tightly screwed to the battery terminals.

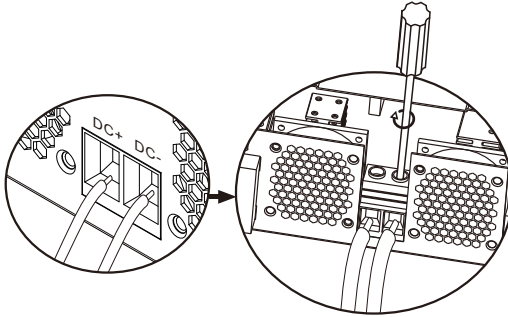

WARNING: Shock Hazard

Installation must be performed with care due to high battery voltage in series.



CAUTION!! Do not place anything between the flat part of the inverter terminal and the ring terminal. Otherwise, overheating may occur.

CAUTION!! Do not apply anti-oxidant substance on the terminals before terminals are connected tightly.

CAUTION!! Before making the final DC connection or closing DC breaker/disconnector, be sure DC (+) must be connected to DC (+) and DC (-) must be connected to DC (-).

AC Input/Output Connection

CAUTION!! Before connecting to AC input power source, please install a separate AC breaker between inverter and AC input power source. This will ensure the inverter can be securely disconnected during maintenance and fully protected from over current of AC input.

The recommended spec of AC breaker is 20A for 2KW, 32A for 3KW.

CAUTION!! There are two terminal blocks with "IN" and "OUT" markings. Please do NOT-misconnect Input and output connectors.

WARNING! All wiring must be performed by a qualified personnel.

WARNING! It's very important for system safety and efficient operation to use appropriate cable for AC input connection. To reduce risk of injury, please use the proper recommended cable size as below.

Suggested cable requirement for AC wires

Model	Gauge	Torque Value
2KW	14AWG	0.8~1.0Nm
3KW	12AWG	1.2~1.6Nm

Please follow below steps to implement AC input/output connection:

1. Before making AC input/output connection, be sure to open DC protector or disconnecter first.
2. Remove insulation sleeve 10mm for six conductors. And shorten phase L and neutral conductor N 3 mm.
3. Insert AC input wires according to polarities indicated on terminal block and tighten the terminal screws. Be sure to connect PE protective conductor (⊕) first.

⊕ → **Ground (yellow-green)**

L → **LINE (brown or black)**

N → **Neutral (blue)**

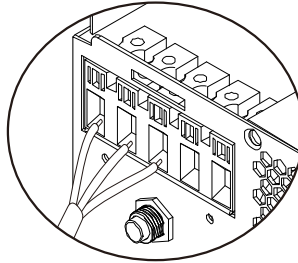

2-3KW



WARNING:

Be sure to that AC power source is disconnected before attempting to hardwire it to the unit.

4. Then, insert AC output wires according to polarities indicated on terminal block and tighten terminal screws. Be sure to connect PE protective conductor (⊕) first.

⊕ → **Ground (yellow-green)**

L → **LINE (brown or black)**

N → **Neutral (blue)**

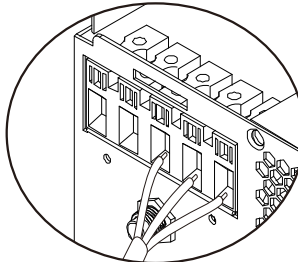

2-3KW

5. Make sure the wires are securely connected.

CAUTION: Important

Be sure to connect AC wires with correct polarity. If L and N wires are connected reversely, it may cause utility short-circuited when these inverters are working in parallel operation.

CAUTION: Appliances such as air conditioner are required at least 2~3 minutes to restart because it's required to have enough time to balance refrigerant gas inside of circuits. If a power shortage occurs and recovers in a short time, it will cause damage to your connected appliances. To prevent this kind of damage, please check manufacturer of air conditioner if it's equipped with time-delay function before installation. Otherwise, this inverter/charger will trig overload fault and cut off output to protect your appliance but sometimes it still causes internal damage to the air conditioner.

PV Connection

CAUTION: Before connecting to PV modules, please install separately a DC circuit breaker between inverter and PV modules.

WARNING! All wiring must be performed by a qualified personnel.

WARNING! It's very important for system safety and efficient operation to use appropriate cable for PV module connection. To reduce risk of injury, please use the proper recommended cable size as below.

Model	Typical Amperage	Cable Size	Torque
2KW/3KW	60A	8AWG	1.4~1.6Nm

PV Module Selection:

When selecting proper PV modules, please be sure to consider below requirements first:

1. Open circuit Voltage (Voc) of PV modules not exceeds max. PV array open circuit voltage of inverter.
2. Open circuit Voltage (Voc) of PV modules should be higher than min. battery voltage.

Solar Charging Mode	
INVERTER MODEL	MPPT charger
Charging Current	60A
Max. PV Array Open Circuit Voltage	145Vdc
PV Array MPPT Voltage Range	30~120Vdc
Min. battery voltage for PV charge	17Vdc
System DC voltage	24Vdc

Please follow below steps to implement PV module connection:

1. Remove insulation sleeve 10 mm for positive and negative conductors.
2. Check correct polarity of connection cable from PV modules and PV input connectors. Then, connect positive pole (+) of connection cable to positive pole (+) of PV input connector. Connect negative pole (-) of connection cable to negative pole (-) of PV input connector.

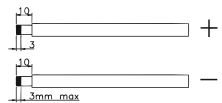

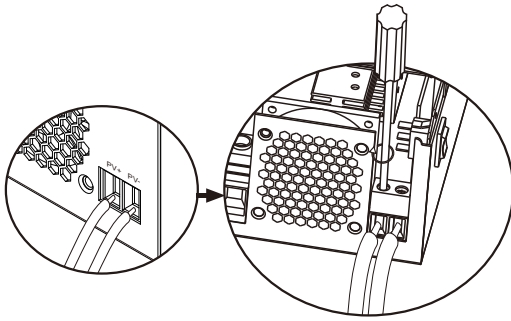

3. Make sure the wires are securely connected.

Recommended PV module configuration

PV Module Spec. (reference)	Inverter Model	Solar Input	Q'ty of modules
-250W -Vmp:30.9Vdc -Imp:8.42A -Voc:37.7Vdc -Isc:8.89A -Cells:60	MPPT-60A	3S3P	9PCS

Solar panel installation schematic

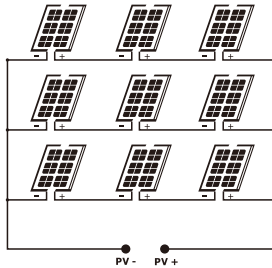

MPPT-60A

Final Assembly

After connecting all wirings, please put bottom cover back by screwing two screws as shown below.

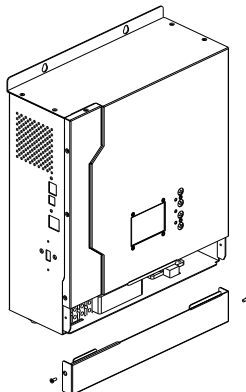

Communication Connection

Please use supplied communication cable to inverter and PC. Download the software by link on the last page of this manual into computer and follow on screen instruction to install the monitoring software. For the detailed software operation, please consult the seller if you have any questions.

WARNING: It's forbidden to use network cable as the communication cable to directly communicate with the PC port. Otherwise, the internal components of the controller will be damaged.

WARNING: RJ45 interface is only suitable for the use of the company's supporting products or professional operation.

Below chart shows RJ45 Pins definition

Pin	Definition
1	RS-485-B
2	RS-485-A
3	GND
4	
5	
6	
7	
8	

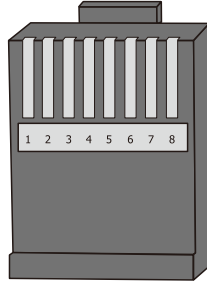

Dry Contact Signal

There is one dry contact (3A/250VAC) available on the rear panel. It can be used to deliver signal to external device when battery voltage reaches warning level.

Unit Status	Condition		Dry contact port		
			NC & C	NO & C	
Power Off	Unit is off and no output is powered.		Close	Open	
Power On	Output is powered from Utility		Close	Open	
	Output is powered from Battery or Solar.	Program 01 set as Utility	Battery voltage < Low DC warning voltage	Open	Close
			Battery voltage > Setting value in Program 21 or battery charging reaches floating stage	Close	Open
	Program 01 is set as SBU or Solar first		Battery voltage < Setting value in Program 20	Open	Close
		Battery voltage > Setting value in Program 21 or battery charging reaches floating stage	Close	Open	

OPERATION

Power ON/OFF

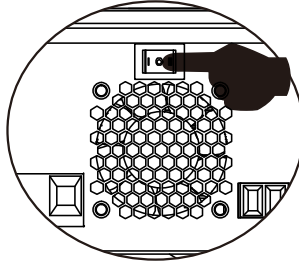

2-3KW

Once the unit has been properly installed and the batteries are connected well, simply press On/Off switch (located on the button of the case) to turn on the unit.

Operation and Display Panel

The operation and display panel, shown in below chart, is on the front panel of the inverter. It includes three indicators, four function keys and a LCD display, indicating the operating status and input/output power information.

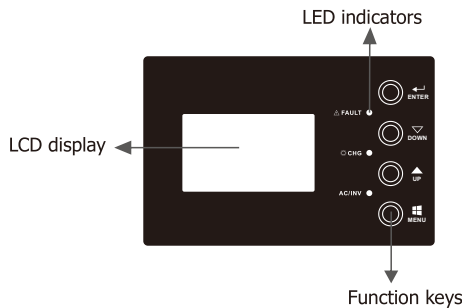

LED Indicator

LED Indicator		Messages	
AC/ INV	Green	Solid On	Output is powered by grid in Line mode.
		Flashing	Output is powered by battery or PV in battery mode.
CHG	Yellow	Flashing	Battery is charging or discharging.
△ FAULT	Red	Solid On	Fault occurs in the inverter.
		Flashing	Warning condition occurs in the inverter.

Function Keys

Function Keys	Description
MENU	Enter reset mode or setting mode go to previous selection.
UP	Increase the setting data.
DOWN	Decrease the setting data.
ENTER	Enter setting mode and Confirm the selection in setting mode go to next selection or exit the reset mode.

LCD Display Icons

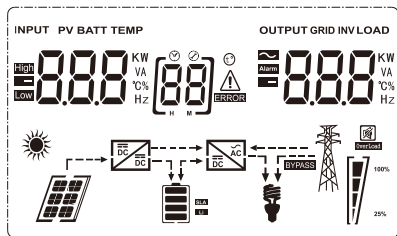

Icon	Function description	
Input Source Information and Output Information		
	Indicates the AC information.	
	Indicates the DC information.	
	Indicate input voltage, input frequency, PV voltage, battery voltage and charger current. Indicate output voltage, output frequency, load in VA, load in Watt and discharging current.	
Configuration Program and Fault Information		
	Indicates the setting programs.	
	Indicates the warning and fault codes. Warning: flashing with warning code. Fault: lighting with fault code.	
Battery Information		
	Indicates battery level by 0-24%, 25-49%, 50-74% and 75-100% in battery mode and charging status in line mode.	
In AC mode, it will present battery charging status.		
Status	Battery voltage	LCD Display
Constant	<2V/cell	4 bars will flash in turns.
Current mode / Constant	2 ~ 2.083V/cell	Bottom bar will be on and the other three bars will flash in turns.
Voltage mode	2.083 ~ 2.167V/cell	Bottom two bars will be on and the other two bars will flash in turns.
	> 2.167 V/cell	Bottom three bars will be on and the top bar will flash.
Batteries are fully charged.		4 bars will be on.

In battery mode, it will present battery capacity.		
Load Percentage	Battery Voltage	LCD Display
Load >50%	< 1.717V/cell	
	1.717V/cell ~ 1.8V/cell	
	1.8 ~ 1.883V/cell	
	> 1.883 V/cell	
50%> Load > 20%	< 1.817V/cell	
	1.817V/cell ~ 1.9V/cell	
	1.9 ~ 1.983V/cell	
	> 1.983V/cell	
Load < 20%	< 1.867V/cell	
	1.867V/cell ~ 1.95V/cell	
	1.95 ~ 2.033V/cell	
	> 2.033V/cell	

Load Information

OVERLOAD	Indicates overload.			
	Indicates the load level by 0-24%, 25-49%, 50-74% and 75-100%.			
	0%~24%	25%~49%	50%~74%	75%~100%

Mode Operation Information

	Indicates unit connected to the mains.
	Indicates unit connected to the PV panel.
BYPASS	Indicates load is supplied by utility power.
	Indicates the solar charger is working.
	Indicates the DC/AC inverter circuit is working.

Mute Operation

	Indicates unit alarm is disabled.
--	-----------------------------------

LCD Setting

After pressing and holding "ENTER" button for 2 seconds, the unit will enter setting mode. Press "UP" or "DOWN" button to select setting programs. And then, press "ENTER" or "MENU" button to confirm the selection and exit.

Setting Programs:

Program	Description	Selectable option
00	Exit setting mode	Escape [00] ESC
01	Output source priority selection	[01] SBU Solar energy provides power to the loads as first priority. If battery voltage has been higher than the setting point in program 21 for 5 minutes, the inverter will turn to battery mode, solar and battery will provide power to the load at the same time. When the battery voltage drops to the setting point in program 20, the inverter will turn to bypass mode, utility provides power to the load only, and the solar will charge the battery at the same time.
		[01] SOL Solar energy provides power to the loads as first priority. If battery voltage has been higher than the setting point in program 21 for 5 minutes, and the solar energy has been available for 5 minutes too, the inverter will turn to battery mode, solar and battery will provide power to the load at the same time. When the battery voltage drops to the setting point in program 20, the inverter will turn to bypass mode, utility provides power to the load only, and the solar will charge the battery at the same time.
		(default) [01] UT Utility will provide power to the loads as first priority. Solar and battery energy will provide power to the loads only when utility power is not available.

02	AC input voltage range	Appliances (default) [02] RPL	If selected, acceptable AC input voltage range will be within 90-280VAC.
		UPS [02] UPS	If selected, acceptable AC input voltage range will be within 170-280VAC.
		VDE [02] VDE	If selected, acceptable AC input voltage range will conform to VDE4105(184VAC-253VAC).
		GEN [02] GEN	When the user uses the device to connect the generator, select the generator mode.
03	Output voltage	[03] 230 ^v	Set the output voltage amplitude, (220VAC-240VAC).
04	Output frequency	50HZ(default) [04] 500	60HZ [04] 600
05	Solar supply priority	[05] BLU	Solar energy provides power to charge battery as first priority.
		(default) [05] LBU	Solar energy provides power to the loads as first priority.
06	Overload bypass: When enabled, the unit will transfer to line mode if overload occurs in battery mode.	Bypass disable [06] BYD	Bypass enable (default) [06] BYE
07	Auto restart when overload occurs	Restart disable (default) [07] LTD	Restart enable [07] LTE
08	Auto restart when over temperature occurs	Restart disable (default) [08] LTD	Restart enable [08] LTE
10	Charger source priority: To configure charger source priority	If this inverter/charger is working in Line, Standby or Fault mode, charger source can be programmed as below:	
		Solar first [10] CSO	Solar energy will charge battery as first priority. Utility will charge battery only when solar energy is not available.
		Solar and Utility (default) [10] SNU	Solar energy and utility will charge battery at the same time.

		Only Solar [10] 050	Solar energy will be the only charger source no matter utility is available or not.
		If this inverter/charger is working in Battery mode or Power saving mode, only solar energy can charge battery. Solar energy will charge battery if it's available and sufficient.	
11	Maximum charging current: To configure total charging current for solar and utility chargers. (Max. charging current=utility charging current +solar charging current)	80A (default) [1] 80 A	Setting range is from 1 A to 80A. Increment of each click is 1A.
13	Maximum utility charging current	20A (default) [13] 20 A	30A (Maximum current) [13] 30 A
14	Battery type	AGM (default) [14] AGM	Flooded [14] FLd
		GEL [14] GEL	LEAD [14] LEA
		Lithium Ion [14] LI	User-Defined [14] USE
		If "User-Defined" LI is selected, battery charge voltage and low DC cut-off voltage can be set up in program 17, 18 and 19.	
17	Bulk charging voltage (C.V voltage)	default setting: 28.2V [17] CV 28.2 V	
		If "User-Defined" LI is selected in program 14, this program can be set up. Setting range is from 24.0V to 29.2V. Increment of each click is 0.1V.	
18	Floating charging voltage	default setting: 27.0V [18] FLV 27.0 V	
		If "User-Defined" LI is selected in program 14, this program can be set up, Setting range is from 24.0V to 29.2V. Increment of each click is 0.1V.	























19	Low DC cut off battery voltage setting	default setting: 20.4V [19] 20.4 ^v	
		If "User-Defined" LI is selected in program 14, this program can be set up. Setting range is from 20.0V to 24.0V. Increment of each click is 0.1V. Low DC cut-off voltage will be fixed to setting value no matter what percentage of load is connected.	
20	Battery stop discharging voltage when grid is available	23V (default) [20] 23.0 ^v	Setting range is from 22.0V to 29.0V. Increment of each click is 0.1V.
21	Battery stop charging voltage when grid is available	27.0V (default) [21] 27.0 ^v	Setting range is from 22.0V to 29.0V. Increment of each click is 0.1V.
22	Auto turn page	(default) [22] PLE	If selected, the display screen will auto turn the display page.
		[22] PLd	If selected, the display screen will stay at latest screen user finally switches.
23	Backlight control	Backlight on [23] LON	Backlight off(default) [23] LOF
24	Alarm control	Alarm on (default) [24] BON	Alarm off [24] BOF
25	Beeps while primary source is interrupted	Alarm on [25] AON	Alarm off (default) [25] AOF
27	Record Fault code	Record enable (default) [27] FON	Record disable [27] FOF
28	Solar power balance: When enabled, solar input power will be automatically adjusted according to connected load power.	Solar power balance enable [28] S6E	If selected, the solar input power will be automatically adjusted according to the following formula: Max. Input solar power = Max. battery charging power + Connected load power when the machine in OffGrid workstate.
		Solar power balance disable (default) [28] S6d	If selected, the solar input power will be the same to max. Battery charging power no matter how much loads are connected. The max. battery charging power will be based on the setting current in program 11 (Max. solar power = Max. battery charging power).









29	Power saving mode enable/disable	Saving mode disable (default) [29] 5d5	If disable, no matter connected load is low or high, the on/off status of inverter output will not be effected.
		Saving mode enable [29] 5e7	If enable, the output of inverter will be off when connected load is pretty low or not detected.
30	Battery equalization	Battery equalization [30] Ee7	Battery equalization disable(default) [30] Ed5
31	Battery equalization voltage	default setting:28.8V [31] E4 288 v	
		Setting range is from 24.0V to 29.2V. Increment of each click is 0.1V.	
33	Battery equalization time	60min(default) [33] 60	Setting range is from 5 min to 900min. Increment of each click is 5min.
34	Battery equalization timeout	120min(default) [34] 120	Setting range is from 5 min to 900min. Increment of each click is 5min.
35	Equalization interval	30days(default) [35] 30d	Setting range is from 0 to 90days. Increment of each click is 1 day.
36	Equalization activated immediately	Enable [36] Aee7	Disable(default) [36] Ad5
		If equalization function is enabled in program 30, this program can be set up. If "Enable" is selected in this program, it's to activate battery equalization immediately and LCD main page will shows "E9 ". If "Disable" is selected, it will cancel equalization function until next activated equalization time arrives based on program 35 setting. At this time, "E9 " will be shown in LCD main page too.	

After pressing and holding "MENU" button for 6 seconds, the unit will enter reset model. Press "Up" and "DOWN" button to select programs. And then ,press "ENTER" button to exit.













set	(default) [dt] n7t	Reset setting disable.
	[dt] 75t	Reset setting enable.

Fault Reference Code







Fault Code	Fault Event	Icon on
01	Fan is locked when inverter is off	
02	Inverter transformer over temperature	
03	battery voltage is too high	
04	battery voltage is too low	
05	Output short circuited	
06	Inverter output voltage is high	
07	Overload time out	
08	Inverter bus voltage is too high	
09	Bus soft start failed	
11	Main relay failed	
21	Inverter output voltage sensor error	
22	Inverter grid voltage sensor error	
23	Inverter output current sensor error	
24	Inverter grid current sensor error	
25	Inverter load current sensor error	
26	Inverter grid over current error	
27	Inverter radiator over temperature	
31	Solar charger battery voltage class error	
32	Solar charger current sensor error	
33	Solar charger current is uncontrollable	
41	Inverter grid voltage is low	
42	Inverter grid voltage is high	

43	Inverter grid under frequency	
44	Inverter grid over frequency	
51	Inverter over current protection error	
52	Inverter bus voltage is too low	
53	Inverter soft start failed	
55	Over DC voltage in AC output	
56	Battery connection is open	
57	Inverter control current sensor error	
58	Inverter output voltage is too low	

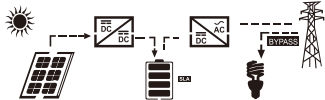
Warning Indicator

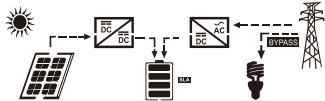
Fault Code	Fault Event	Icon on
61	Fan is locked when inverter is on.	
62	Fan 2 is locked when inverter is on.	
63	Battery is over-charged.	
64	Low battery.	
67	Overload.	
70	Output power derating.	
72	Solar charger stops due to low battery.	
73	Solar charger stops due to high PV voltage.	
74	Solar charger stops due to over load.	
75	Solar charger over temperature.	
76	PV charger communication error.	
77	Parameter error.	

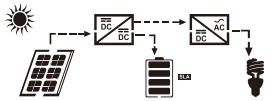
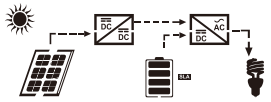
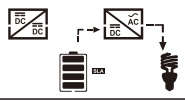
Operating State Description

Operation state	Description	LCD display
Utility-Tie state	PV energy is charger into the battery and utility provide power to the AC load.	PV is on 
		PV is off 
Charge state	PV energy and grid can charge batteries.	
Bypass state	Error are caused by inside circuit error or external reasons such as over temperature, output short circuited and so on.	
Off-Grid state	The inverter will provide output power from battery and PV power.	Inverter power loads from PV energy 
		Inverter power loads from battery and PV energy 
		Inverter power loads from battery only 
Stop mode	The inverter stop working if you turn off the inverter by the soft key or error has occurred in the condition of no grid.	

Display Setting

The LCD display information will be switched in turns by pressing "UP" or "DOWN" key. The selectable information is switched as below order: battery voltage, battery current ,inverter voltage, inverter current, grid voltage, grid current, load in Watt, load in VA, grid frequency, inverter frequency, PV voltage, PV charging power, PV charging output voltage, PV charging output current.

Selectable information	LCD display	
Battery voltage/DC discharging current	^{BATT} 260 ^V	480 ^A
Inverter output voltage/Inverter output current	229 ^V	^{INV} 6.70 ^A
Grid voltage/Grid current	229 ^V	-30 ^A
Load in Watt/VA	150 ^{KW}	^{LOAD} 168 ^{KVA}
Grid frequency/Inverter frequency	^{INPUT} 500 ^{Hz}	^{INV} 500 ^{Hz}
PV voltage and power	^{PV} 6.10 ^V	100 ^{KW}
PV charger output voltage and MPPT charging current	^{PV} 250 ^V	^{OUTPUT} 400 ^A

SPECIFICATIONS

Table 1 Line Mode Specifications

INVERTER MODEL	2-3KW
Input Voltage Waveform	Sinusoidal (utility or generator)
Nominal Input Voltage	230Vac
Low Loss Voltage	90Vac±7V(APL,GEN); 170Vac±7V(UPS) 186Vac±7V(VDE)
Low Loss Return Voltage	100Vac±7V(APL,GEN);180Vac±7V(UPS) 196Vac±7V(VDE)
High Loss Voltage	280Vac±7V(APL, UPS,GEN) 253Vac±7V(VDE)
High Loss Return Voltage	270Vac±7V(APL,UPS,GEN) 250Vac±7V(VDE)
Max AC Input Voltage	300Vac
Nominal Input Frequency	50Hz / 60Hz (Auto detection)
Low Loss Frequency	40Hz±1Hz(APL,UPS,GEN) 47.5Hz±0.05HZ(VDE)
Low Loss Return Frequency	42Hz±1Hz(APL,UPS,GEN) 47.5Hz±0.05HZ(VDE)
High Loss Frequency	65Hz±1Hz(APL,UPS,GEN) 51.5Hz±0.05HZ(VDE)
High Loss Return Frequency	63Hz±1Hz(APL,UPS,GEN) 50.05Hz±0.05HZ(VDE)
Output Short Circuit Protection	Line mode: Circuit Breaker Battery mode: Electronic Circuits
Efficiency (Line Mode)	>95% (Rated R load, battery full charged)
Transfer Time	10ms typical (UPS,VDE) 20ms typical (APL)
<p>Output power derating: When AC input voltage drops to 170V depending on models, the output power will be derated</p>	<p>230Vac model:</p>  <p>The graph illustrates the output power derating characteristics for a 230Vac model. The vertical axis represents Output Power, and the horizontal axis represents AC Input Voltage. The output power is constant at the Rated Power level from 170V up to 280V. At 170V, the output power begins to derate linearly, reaching 50% of the Rated Power at 90V. Below 90V, the output power is zero.</p>

Table 2 Inverter Mode Specifications

INVERTER MODEL	2-3KW
Rated Output Power	2000W/3000W
Output Voltage Waveform	Pure Sine Wave
Output Voltage Regulation	230Vac±5%
Output Frequency	60Hz or 50Hz
Peak Efficiency	90%
Overload Protection	5s@≥150% load; 10s@110%~150% load
Nominal DC Input Voltage	24Vdc
Cold Start Voltage	23.0Vdc
Low DC Warning Voltage	
@ load < 20%	22.0Vdc
@ 20% ≤ load < 50%	21.4Vdc
@ load ≥ 50%	20.2Vdc
Low DC Warning Return Voltage	
@ load < 20%	23.0Vdc
@ 20% ≤ load < 50%	22.4Vdc
@ load ≥ 50%	21.2Vdc
Low DC Cut-off Voltage	
@ load < 20%	21.0Vdc
@ 20% ≤ load < 50%	20.4Vdc
@ load ≥ 50%	19.2Vdc
High DC Recovery Voltage	29Vdc
High DC Cut-off Voltage	30Vdc

Table 3 Charge Mode Specifications

Utility Charging Mode		
INVERTER MODEL	2-3KW	
Charging Current @Nominal Input Voltage	20/30A	
Floating charging voltage	AGM / Gel/LEAD Battery	27.4Vdc
	Flooded Battery	27.4Vdc
Bulk charging voltage (C.V voltage)	AGM / Gel/LEAD Battery	28.8Vdc
	Flooded Battery	28.4Vdc
Charging Algorithm	3-Step(Flooded Battery, AGM/Gel Battery), 4-Step(LI)	
Solar Charging Mode		
INVERTER MODEL	2-3KW	
Charging Current	MPPT-60A	
System DC Voltage	24Vdc	
Operating Voltage Range	30-120Vdc	
Max.PV Array Open Circuit Voltage	145Vdc	
Standby Power Consumption	2W	
Battery Voltage Accuracy	+/-0.3%	
PV Voltage Accuracy	+/-2V	
Charging Algorithm	3-Step(Flooded Battery, AGM/Gel Battery),4-Step(LI)	
Charging algorithm for lead acid battery		

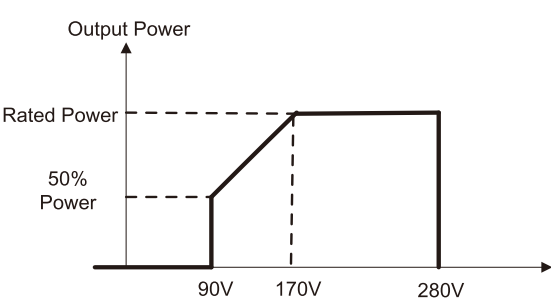
<p>Charging algorithm for Lithium battery</p>	
<p>Joint Utility and Solar Charging</p>	
<p>INVERTER MODEL</p>	<p>2KW-3KW</p>
<p>CHARGER MODEL</p>	<p>MPPT-60A</p>
<p>Max Charging Current</p>	<p>80A</p>
<p>Default Charging Current</p>	<p>80A</p>

Table 4 General Specifications

<p>INVERTER MODEL</p>	<p>2KW-3KW</p>
<p>Safety Certification</p>	<p>CE</p>
<p>Operating Temperature Range</p>	<p>-10°C to 50°C</p>
<p>Storage temperature</p>	<p>-15°C~ 60°C</p>
<p>Dimension (D*W*H), mm</p>	<p>324.09 x 289.8x 118.3</p>
<p>Net Weight, kg</p>	<p>6.9</p>

TROUBLE SHOOTING

Problem	LCD/LED/Buzzer	Explanation/Possible cause	What to do
Unit shuts down automatically during startup process.	LCD/LEDs and buzzer will be active for 3 seconds and then complete off.	The battery voltage is too low. (<1.91V/Cell)	1. Re-charge battery. 2. Replace battery.
No response after power on.	No indication.	1. The battery voltage is far too low. (<1.4V/Cell) 2. Battery polarity is connection reversed.	1. Check if batteries and the wires are connected properly. 2. Re-charge battery. 3. Replace battery.
Mains exist but the unit works in battery mode.	Input voltage is displayed as 0 on the LCD and green LED is flashing.	Input protector is tripped.	Check if AC breaker is tripped or AC wiring is connected right .
	Green LED is flashing.	Insufficient quality of AC power. (Shore or Generator)	1. Check if AC wires are too thin and/or too long. 2. Check generator (if applied) is working well or check if input voltage range setting is correct. (Appliance –Wide)
When the unit is turned on, internal relay is switched on and off repeatedly.	LCD display and LED are flashing.	Battery is disconnected.	Check if battery wires are connected right .
Buzzer beeps continuously and red LED is on.	Fault code 07	Overload error. The inverter is overload 110%and time is up.	Reduce the connected load by switching off some equipment.
	Fault code 05	Output short circuited.	Check if wiring is connected right and remove abnormal load.
	Fault code 02	Internal temperature of inverter component is over 90°C.	Check whether the air flow of the unit is blocked or whether the ambient temperature is too high.
	Fault code 03	Battery is over charged.	Return to repair center.
		The battery voltage is too high.	Check if spec and quantity of batteries meet requirements.
	Fault code 01	Fan fault.	Replace the fan.
	Fault code 06/58	Output abnormal .(Inverter voltage below than 202Vac or is higher than 253Vac)	1. Reduce the connected load. 2. Return to repair center
	Fault code 08/09/53/57	Internal components failed.	Return to repair center
	Fault code 51	Over current or surge.	Restart the unit, if the error
	Fault code 52	Bus voltage is too low.	happens again, please
Fault code 55	Output voltage is unbalanced.	return to repair center.	
Fault code 56	Battery is not connected right or fuse is burnt.	If the battery is connected well, please return to repair center.	

Appendix: Approximate Back-up Time Table

Model	Load (W)	Backup Time @ 24Vdc 100Ah (min)	Backup Time @ 24Vdc 200Ah (min)
2KW	200	766	1610
	400	335	766
	600	198	503
	800	139	339
	1000	112	269
	1200	95	227
	1400	81	176
	1600	62	140
	1800	55	125
	2000	50	112
3KW	300	449	1100
	600	222	525
	900	124	303
	1200	95	227
	1500	68	164
	1800	56	126
	2100	48	108
	2400	35	94
	2700	31	74
	3000	28	67

Note: Backup time depends on the quality of the battery, age of battery and type of battery. Specifications of batteries may vary depending on different manufacturers.

USER'S MANUAL

SOLAR INVERTER

Please download the software “SolarPowerMonitor2.2.81”.

Oversea:<https://bit.ly/2PyyLg6>

